

# ESDEC

INNOVATIVE MOUNTING SYSTEMS

## THE VERSATILE CLICK SYSTEM FOR FLAT ROOFS

**FLATFIX**

FUSION

[www.esdec.com](http://www.esdec.com)

# THE ADVANTAGES OF FLATFIX FUSION



## FLEXIBLE AND EASY

- Completely modular system
- Flexible installation
- Easy to build around obstacles
- Aesthetic lightweight system
- Single or dual setup
- Suitable for residential and commercial projects



## RELIABLE

- Aerodynamic design
- Robust system thanks to connectors parallel and perpendicular to the panels
- Wind deflectors designed for maximum safety
- Tested to international standards
- 20-year warranty



## SAFETY FOR THE ROOF

- For every type of roof
- Roof support with movable connectors
- Unique thermal decoupling prevents damage to roof material
- Optimum point pressure due to distributed ballast
- Integrated grounding and bonding in accordance with IEC 60364 series

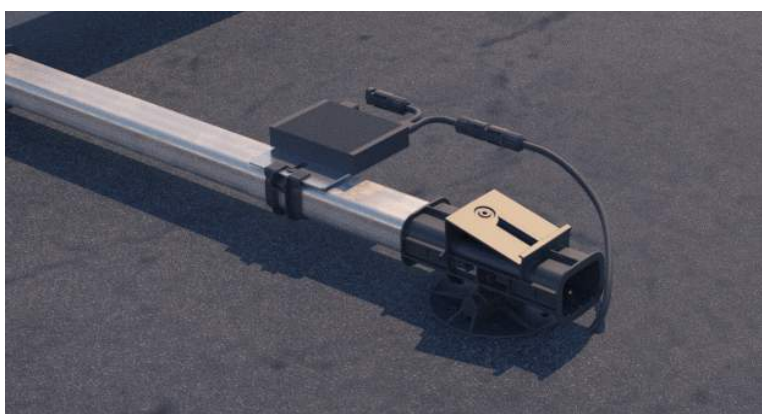

## EASY TO INSTALL

- User-friendly click system
- Optimizer ready cable clip for easy attachment and safe cable removal
- Optimizer clip can also be used for most micro inverters
- For the most common solar panels (angle of inclination 13°)





# COMPLETE AND FLEXIBLE INSTALLATION ON EVERY ROOF

FlatFix Fusion is a 100% Dutch product that has proven itself over many years: the modular and flexible system for flat roofs. FlatFix is an ideal mounting solution for solar panels on medium and smaller roofs. Its modular design enables a customized configuration to be created for every roof. Installers can, for example, easily build around obstacles – such as chimneys – with this system. FlatFix Fusion can be set up either in dual or single configuration.

## Easy to install

Esdec was founded by professional installers, the interest of the installer always come first when designing our products. Simplicity and flexibility were therefore the starting points in the design of our FlatFix Fusion system. Smart click connections enable the system to be assembled quickly.

## Safety for the roof

The different components are connected using fast-click connectors. The roof supports with movable connectors allow the system to move (expand and shrink) to prevent damages of the roof material. As a result, the thermal movements of the building are not transmitted to the PV system and vice versa.

## Reliability

The patented FlatFix Fusion system has been extensively tested on fire safety, wind resistance and corrosion. FlatFix Fusion is a high-quality mounting solution. It complies with the strictest international standards and comes with a 20-year warranty.

### ADVANTAGES FOR THE INSTALLER

- ✓ Modular mounting solution with click connection
- ✓ Flexible installation on any roof
- ✓ Integrated grounding and equipotential bonding
- ✓ Ease of installation with optimizer ready cable clip

### ADVANTAGES FOR THE END USER

- ✓ Roof-specific configuration
- ✓ Safe and reliable
- ✓ No damage of the roof material
- ✓ 20-year warranty

## Dual setup

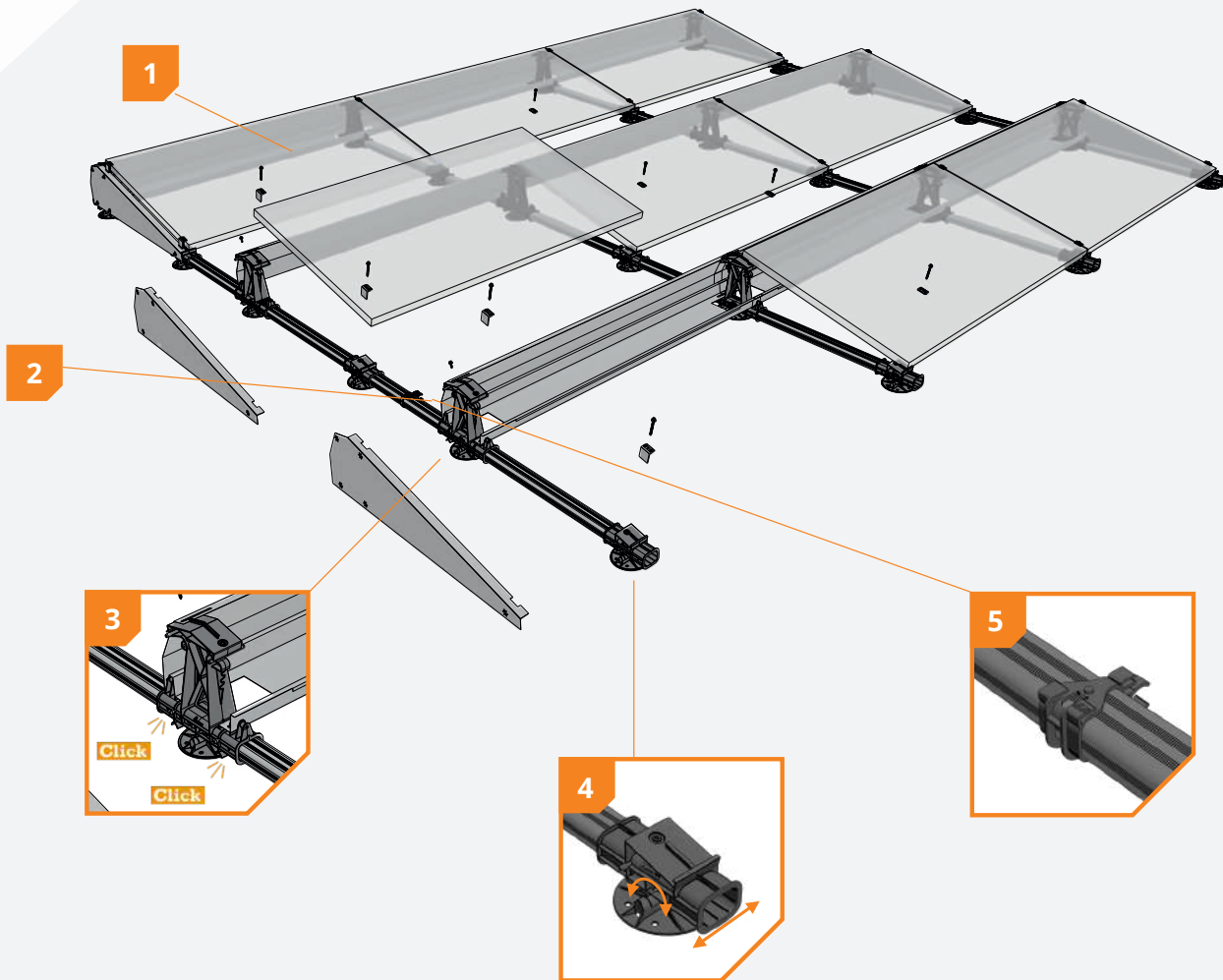
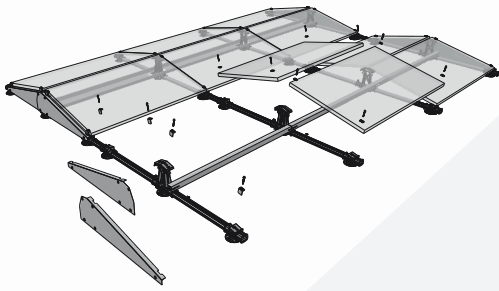

### 1 Modular click system

The different components enable flexible row lengths. This makes it possible to create a roof-specific setup and, for example, to build around obstacles.

### 2 Lightweight system

FlatFix Fusion is made of strong, lightweight materials. The solar panels are connected lengthwise and across their width. This makes the mounting solution additionally robust.

### 3 Unique click connection

The revolutionary, unique click connection makes the FlatFix Fusion a very quick and easy-to-install mounting solution.











### 4 With thermal decoupling

The roof supports with movable connectors give the system space to expand thermally without damaging the roof material.

### 5 With integrated cable management

The cables and plugs of the solar panels can be safely and easily attached to the mounting solution. This reduces the installation time and increases the installation quality.

## SYSTEM COMPONENTS

 FlatFix Fusion roof support 1007012	 FlatFix Fusion wind deflector left** 1007204
 FlatFix Fusion low base 1007021 1007021-S (with bonding)	 FlatFix Fusion wind deflector right** 1007205
 FlatFix Fusion high base 1007030 1007030-S (with bonding)	 FlatFix Fusion ballast container*/** 1007202
 FlatFix Fusion cable-clip optimizer ready*** 1007041	 FlatFix Fusion stabilizer*/** 1007203
 FlatFix Fusion wind deflector rear*/** 1007201	 FlatFix Fusion base profile** 210mm 1007121 370mm 1007137 550mm 1007155 750mm 1007175 940mm 1007194

\* Also available in 1200, 1500, 1600, 1700, 1900 & 2000

\*\* Also available in black



\*\*\* Also suitable for most micro inverters

## FASTENERS

 Esdec mounting screw*	
6,5x19mm	1006519
6,5x55mm	1006555
6,5x60mm	1006560
6,5x63mm	1006563
6,5x70mm	1006570
6,5x75mm	1006575
6,5x80mm	1006580
6,5x85mm	1006585
 Esdec screw	
6,0 x 25mm (self tapping)	100-3010
6,3 x 32 (self drilling)	100-3015

\* Depending on panel thickness and related end clamp







## CLAMPS

 Flatfix Fusion universal module clamp with bonding** 1003022
 FlatFix end clamp 31-50mm*/** 10041_

\* Depending on panel thickness (in mm)

\*\* Also available in black

## ACCESSORIES

 FlatFix Fusion grounding spring 1007502**	 FlatFix Fusion roof support adapter 1007011
 FlatFix Fusion grounding clamp (6mm <sup>2</sup> ) 1007505	 FlatFix Fusion low base extension 1007021-WP
 Esdec support screw cap, black* 1006500	 FlatFix Fusion earthing bracket 1007503
 FlatFix Fusion TPO Mat 1007015	

\* Combined with black systems

\*\* Also available ready-assembled, see SYSTEM COMPONENTS

## Calculator

- Easily calculate ballast
- Overview of required materials
- Automatically generated construction plan

Go to [esdec.com/calculator](https://www.esdec.com/calculator)



## Warranty

- Use of premium materials
- Thoroughly tested
- 20-year warranty





**QUICK  
RELIABLE  
INNOVATIVE**

Esdec has been developing, producing and supplying professional roof-mounting systems for solar panels since 2004. ClickFit and FlatFix are inspired by all installers who regularly install solar panels. Easy, quick, reliable installation using innovative, high-quality, durable mounting systems: Esdec makes it possible.

**Esdec**

Londenstraat 16  
7418 EE Deventer  
Netherlands

☎ +31 850 702 000

✉ info@esdec.com

05062020

[www.esdec.com](http://www.esdec.com)