

# Multi RS Solar

Rev 08 - 07/2023

This manual is also available in [HTML5](#).

# Table of Contents

<b>1. Multi RS Solar Product Manual</b> .....	<b>1</b>
<b>2. Safety Instructions</b> .....	<b>2</b>
<b>3. General Description</b> .....	<b>4</b>
3.1. Two AC outputs .....	4
3.2. PowerControl - maximum use of limited AC power .....	4
3.3. PowerAssist - extended use of AC input current .....	4
3.4. Programmable .....	4
3.5. Programmable relay .....	4
3.6. Programmable analog/digital input/output ports .....	4
3.7. Built-in Battery Monitor .....	4
3.8. High efficiency .....	5
3.9. Frequency shift function .....	5
3.10. High power inverter .....	5
3.11. Interfacing and Communications .....	5
3.12. Battery charger .....	6
3.12.1. Lead-acid batteries .....	6
3.12.2. Li-ion batteries .....	6
3.12.3. More on batteries and battery charging .....	7
3.13. Setup options .....	7
3.14. Limitations .....	7
<b>4. Installation</b> .....	<b>9</b>
4.1. Location of the inverter .....	9
4.2. Battery and battery lead requirements .....	9
4.3. Solar array configuration .....	10
4.3.1. Multi RS Solar example PV configuration .....	10
4.4. MPPT grounding, detection of PV array insulation faults & Earth fault alarm notification .....	11
4.5. Cable connection sequence .....	11
4.6. Battery connection procedure .....	11
4.7. Connection of the AC cabling .....	12
4.8. VE.Direct .....	12
4.9. VE.Can .....	13
4.10. Bluetooth .....	13
4.11. User I/O .....	13
4.11.1. Remote on/off connector .....	13
4.11.2. Programmable relay .....	13
4.11.3. Voltage sense .....	13
4.11.4. Temperature sensor .....	13
4.11.5. Programmable analog/digital input ports .....	14
4.11.6. User I/O terminal diagram .....	14
4.11.7. User I/O functions .....	14
4.12. Programming with VictronConnect .....	14
4.12.1. Settings .....	15
4.12.2. Battery settings .....	15
4.12.3. Generator programming .....	18
4.12.4. UPS behaviour .....	19
4.12.5. AC Input Control .....	19
4.12.6. Inverter Modes .....	21
4.12.7. ESS controls .....	22
4.13. Connecting to AC PV inverters .....	23
4.14. Large systems - 3 phase .....	23
4.15. 3 phase installation .....	23
4.16. 3 phase programming .....	24
<b>5. Operation</b> .....	<b>27</b>
5.1. Device display .....	27
5.2. History - Thirty-day graphic .....	28
5.3. Protections and automatic restarts .....	29
5.3.1. Overload .....	29
5.3.2. Low battery voltage thresholds (adjustable in VictronConnect) .....	30
5.3.3. High battery voltage .....	30

5.3.4. High temperature .....	30
<b>6. Troubleshooting Guide - MPPT .....</b>	<b>31</b>
6.1. Troubleshooting and support .....	31
6.2. The solar charger is unresponsive .....	31
6.3. Solar charger is off .....	31
6.3.1. PV voltage too low .....	32
6.3.2. Reverse PV polarity .....	33
6.4. Solar charger externally controlled .....	33
6.5. Batteries are not charged .....	33
6.5.1. Battery is full .....	34
6.5.2. Battery not connected .....	34
6.5.3. Battery settings too low .....	35
6.5.4. Reverse battery polarity .....	36
6.5.5. Reverse PV polarity .....	36
6.6. Batteries are undercharged .....	36
6.6.1. Insufficient solar .....	37
6.6.2. Too much DC load .....	37
6.6.3. Battery cable voltage drop .....	37
6.6.4. Wrong temperature compensation setting .....	38
6.7. Batteries are overcharged .....	38
6.7.1. Battery charge voltages too high .....	38
6.7.2. Battery unable to deal with equalization .....	38
6.7.3. Battery old or faulty .....	39
6.8. PV problems .....	39
6.8.1. PV yield less than expected .....	40
6.8.2. Full rated output not reached .....	40
6.8.3. Mixed PV panel types .....	41
6.8.4. MC4 connectors wrongly connected .....	41
6.8.5. PV connections burned or melted .....	41
6.8.6. Optimisers cannot be used .....	41
6.8.7. Ground current .....	41
6.8.8. PV voltage too high .....	41
6.9. Communication problems .....	42
6.9.1. VictronConnect app .....	42
6.9.2. Bluetooth .....	42
6.9.3. VE.Direct port .....	43
6.9.4. VE.Smart communication .....	43
6.10. Error code overview .....	44
<b>7. Technical Specifications .....</b>	<b>50</b>
<b>8. Appendix .....</b>	<b>53</b>
8.1. Appendix A : Connection Overview .....	53
8.2. Appendix B : Block Diagram .....	55
8.3. Appendix C : Example Wiring Diagram .....	55
8.4. Appendix D : Dimensions .....	57

# 1. Multi RS Solar Product Manual

## Introduction

---

The Victron Multi RS Solar integrates the following elements:

- A powerful inverter/charger
- A high power MPPT solar charge controller

This document explains:

- Features
- Behaviour
- Specifications
- Limitations
- Installation instructions
- Troubleshooting steps

You must read it to understand how to use your product safely and reliably.

This manual applies to:

- Multi RS Solar 48/6000/100-450/100 - PMR482602020



**IMPORTANT** - The Multi RS Solar has limitations and restrictions that are subject to change with updates to firmware - please contact your Victron Dealer or Victron Sales Manager prior to purchase to understand these limitations and if this product is suitable for your specific application. For example, generator input support requires a v1.11 firmware update.

## 2. Safety Instructions



### ELECTRIC SHOCK HAZARD

Please read this manual carefully before the product is installed and put into use.

This product is designed and tested in accordance with international standards. The equipment should be used for the designated application only.

Refer to the specifications provided by the manufacturer of the battery to ensure that the battery is suitable for use with this product. The battery manufacturer's safety instructions should always be observed.

Protect the solar modules from incident light during installation, e.g. cover them.

Never touch uninsulated cable ends.

Use only insulated tools.

Connections must always be made in the sequence described in the installation section of this manual.

The installer of the product must provide a means for cable strain relief to prevent the transmission of stress to the connections.

In addition to this manual, the system operation or service manual must include a battery maintenance manual applicable to the type of batteries used. The battery must be placed in a well-ventilated area.



### SELECTION OF WIRE CONDUCTORS

Use flexible multistranded copper cable for the battery and PV connections.

The maximum diameter of the individual strands is 0,4mm/0,125mm<sup>2</sup> (0.016 inch/AWG26).

A 25mm<sup>2</sup> cable, for example, should have at least 196 strands (class 5 or higher stranding according to VDE 0295, IEC 60228 and BS6360).

An AWG2 gauge cable should have at least 259/26 stranding (259 strands of AWG26)

Maximum operating temperature:  $\geq 90^{\circ}\text{C}$

Example of suitable cable: class 5 "Tri-rated" cable (it has three approvals: American (UL), Canadian (CSA) and British (BS)).

In case of thicker strands the contact area will be too small and the resulting high contact resistance will cause severe overheating, eventually resulting in fire.



### RISK OF INJURY OR DEATH

The internals can carry a 400-500V DC voltage even when the product is off!

Input and/or output terminals may still be dangerously energized, even when the equipment is switched off. Always disconnect all power connections (e.g. the battery, DC solar isolator, etc) and wait at least 5 minutes before carrying out work on the product.

The product has no internal user-serviceable components. Do not remove the front plate or operate the product if any panels have been removed. All servicing must be undertaken by qualified personnel.

Please read the installation instructions in the installation manual before installing the equipment.

This is a Safety Class I product (supplied with a protective grounding terminal). The chassis must be grounded. Whenever it is likely that the grounding protection has been damaged, the product must be turned off and secured against unintended operation; please contact qualified service staff.

Non-isolated inverters shall be provided with installation instructions that require PV modules that have an IEC 61730 Class A rating.

If the maximum AC mains operating voltage is higher than the PV array maximum system voltage, then the instructions shall require PV modules that have a maximum system voltage rating based upon the AC mains voltage.





### Environment and Access

Ensure that the equipment is used under the correct ambient conditions. Never operate the product in a wet or dusty environment. Never use the product where there is a risk of gas or dust explosions. Ensure there is adequate free space for ventilation above and below the product and check that the ventilation vents are not blocked.

Installation of this product must in a location that restricts access by persons (including children) with reduced physical, sensory or mental capabilities, or lack of experience and knowledge, unless they have been given supervision or instruction concerning use of the appliance by a person responsible for their safety.

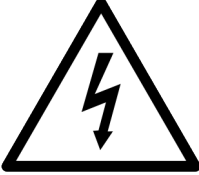
The connections to live parts should be covered after installation.

### Enclosure Symbols

Symbol on the enclosure	
	Caution, risk of electric shock
	Refer to the operating instructions
IP21	IP21 Protected from touch by fingers and objects greater than 12 millimetres. Protected from condensation.
	European conformity
	Regulatory compliance mark for Australia & New Zealand

## 3. General Description

The Multi RS Solar is a combined inverter/charger and MPPT solar charger.

It is designed to operate with a 48V battery bank and produces a pure AC sine wave at 230V.

### 3.1. Two AC outputs

Besides the usual uninterruptible output (AC-out-1), an auxiliary output (AC-out-2) is available that disconnects its load in the event of battery-only operation. Example: an electric boiler that is allowed to operate only if the AC input is available. There are several applications for AC-out-2.

### 3.2. PowerControl - maximum use of limited AC power

The product can supply a huge charging current. This implies heavy loading of the AC input. Therefore a maximum current can be set. The product then takes other power users into account, and only uses 'surplus' current for charging purposes.

### 3.3. PowerAssist - extended use of AC input current

This feature takes the principle of PowerControl to a further dimension allowing the product to supplement the capacity of the alternative source. Where peak power is often required only for a limited period, the product will make sure that insufficient AC input power is immediately compensated for by power from the battery. When the load reduces, the spare power is used to recharge the battery.

The Multi RS can provide throughput of up to 50 A to the loads. The AC input relays are limited to 50 A (Multi RS - 2 tracker), and the inverter can contribute up to 25 A continuous at best conditions (when it gets hotter this figure will be reduced).

This power comes from either the battery and/or the DC PV (the DC PV power also has to go through the inverter before it reaches the AC loads).

### 3.4. Programmable

All programmable settings and grid-interactive setpoints for this product can be changed with either a mobile phone or computer (Windows requires VE.Direct to USB dongle), using the free VictronConnect software available on the App Store of your device, or [www.victronenergy.com](http://www.victronenergy.com).

### 3.5. Programmable relay

The product is equipped with a programmable relay. The relay can be programmed for different applications, for example as a starter relay.

### 3.6. Programmable analog/digital input/output ports

The product is equipped with 2 analog/digital input/output ports.

These ports can be used for several purposes. One application is communication with the allow-to-charge and allow-to-discharge BMS controls of a lithium-ion battery.

See appendix.

### 3.7. Built-in Battery Monitor

The ideal solution when the product is part of a hybrid system (AC input, inverter/chargers, storage battery, and alternative energy). The built-in battery monitor can be set to open and close the relay:

- start at a preset % discharge level
- start (with a preset delay) at a preset battery voltage
- start (with a preset delay) at a preset load level
- stop at a preset battery voltage
- stop (with a preset delay) after the bulk charge phase has been completed
- stop (with a preset delay) at a preset load level

### 3.8. High efficiency

**Outstanding inverter/charger efficiency** - Maximum efficiency of 96%. The inverter is short circuit proof and protected against overheating, whether due to overload or high ambient temperature.

**Ultra-fast Maximum Power Point Tracking (MPPT)** - Especially in case of a clouded sky, when light intensity is changing continuously, a fast MPPT algorithm will improve energy harvest by up to 30% compared to PWM charge controllers and by up to 10% compared to slower MPPT controllers.

**Advanced Maximum Power Point Detection in case of partial shading conditions** - If partial shading occurs, two or more maximum power points may be present on the power-voltage curve. Conventional MPPTs tend to lock to a local MPP, which may not be the optimum MPP. The innovative SmartSolar algorithm will always maximize energy harvest by locking to the optimum MPP.

### 3.9. Frequency shift function

When external PV inverters are connected to the output of the inverter, excess solar energy is used to recharge the batteries. Once the battery absorption voltage is reached, charge current will reduce by shifting the output frequency higher. This frequency shift is automatic and does not require configuration on the Multi RS Solar, though the AC PV inverter may require additional configuration.

This feature is used for battery over charge protection and solar assist.

The Multi RS Solar does not allow complete charging of the battery from an AC PV inverter to fully 100% State of Charge.

That is a safety precaution to prevent overcharging of the battery when the AC PV output cannot be adjusted quickly enough to prevent a system shutdown, so when charging from AC PV, there is some capacity left in the battery remaining to absorb this surplus.

To complete a full charge from solar, connect PV to the internal MPPT solar charger, or another DC MPPT.

### 3.10. High power inverter

**High peak power** - The inverter is able to supply a maximum AC output power to a peak 9000W or 50A AC, for 3 seconds. This supports smooth operation for motor start up and other demanding surge loads.

**Continuous power output, with solar boost** - Continuous output power at 25C ambient, at 52VDC, is 5300W. When combined with solar power from the built-in MPPT this increases approximately 10% to 5800W.

**Isolated PV connections for additional safety** - Full galvanic isolation between PV and battery connections provide additional overall system safety.

**Temperature Protected** - Over-temperature protection and power derating when temperature is high.

### 3.11. Interfacing and Communications

#### VE.Direct port and two VE.Can ports

The Multi RS Solar only supports a data connection to a GX device (i.e Cerbo GX) via the VE.Can port, and not the VE.Direct port. The VE.Direct port can be used to connect a GlobalLink 520 for remote data monitoring, or USB to VE.Direct dongle for VictronConnect access on a Windows computer.

#### Device Display

A 4 line LCD back-lit display shows operational information including battery levels, solar yield, and system icons.

#### User I/O connector:

- Aux 1, 2 input
- Programmable relay
- Battery voltage sense (Vsense)
- Battery temperature sense (Tsense)
- Remote H & Remote L - Configurable

#### Bluetooth Smart built-in

The wireless solution to set-up, monitor and update the controller using Apple and Android smartphones, tablets or other compatible devices.

#### Configuring and monitoring with VictronConnect



Configure with the VictronConnect app. Available for iOS, Android devices, as well as macOS and Windows computers. A VE.Direct to USB accessory is required for Windows systems; enter VictronConnect in the search box on our website and see the VictronConnect download page for details.



## 3.12. Battery charger

The batteries can be charged by solar energy using the built-in MPPT solar controller, a compatible AC supply connected to the AC input, or an AC PV grid inverter connected to the AC output. The built-in MPPT has a power limit of 6000 W total - 3000 W per tracker. If an additional PV grid inverter is connected (max 5000W), the maximum total charging current is limited to 100A. The maximum charging current of 100A is reduced if battery voltage goes above 60V. A custom maximum charge current value can also be defined by the installer in VictronConnect. If using a PV grid inverter, it will only charge the battery to ~95%.

The charger algorithm is the same as for the BlueSolar MPPT solar controllers. This provides built-in battery preset parameters, and allows for expert mode to define additional charging parameters.

### 3.12.1. Lead-acid batteries

#### Adaptive 4-stage charge algorithm: bulk – absorption – float – storage

The microprocessor-driven adaptive battery management system can be adjusted for various types of batteries. The adaptive function automatically adapts the charging process to battery use.

#### The right amount of charge: variable absorption time

In the event of slight battery discharge, absorption is kept short to prevent overcharging and excessive gas formation. After deep discharging, the absorption time is automatically extended in order to fully charge the battery.

#### Preventing damage due to excessive gassing: the BatterySafe mode

If, in order to quickly charge a battery, a high charge current in combination with a high absorption voltage has been chosen, damage due to excessive gassing will be prevented by automatically limiting the rate of voltage increase once the gassing voltage has been reached.

#### Less maintenance and aging when the battery is not in use: the Storage mode

The Storage mode kicks in whenever the battery has not been subjected to discharge during 24 hours. In the Storage mode float voltage is reduced to 2,2V/cell to minimise gassing and corrosion of the positive plates. Once a week the voltage is raised back to the absorption level to 'equalize' the battery. This feature prevents stratification of the electrolyte and sulphation, a major cause of early battery failure.

#### Battery voltage sense: the correct charge voltage

Voltage loss due to cable resistance can be compensated by using the voltage sense facility to measure voltage directly on the DC bus or on the battery terminals.

#### Battery voltage and temperature compensation

The temperature sensor (supplied with the product) serves to reduce charging voltage when battery temperature rises. This is particularly important for maintenance-free batteries, which could otherwise dry out by overcharging.

### 3.12.2. Li-ion batteries

#### Victron LiFePO4 Smart batteries

When using Victron lithium batteries, the system will need to be wired using the allow to charge, and allow to discharge contacts from the Victron smallBMS to the I/O connection port. This will also need to be configured to BMS mode when commissioning the product in VictronConnect.

#### Compatible BMS-Can Lithium Batteries

Compatible BMS-Can lithium batteries can be used with Multi RS Solar however it is a requirement that those batteries to be connected via the BMS-Can port of the GX device (such as the Cerbo GX), and not to the Multi RS Solar communications interface directly. See the [Victron Battery Compatibility Guide for more specific information](#).

### 3.12.3. More on batteries and battery charging

Our book 'Energy Unlimited' offers further information on batteries and battery charging, and is available free of charge on our website: <https://www.victronenergy.com/support-and-downloads/technical-information>.

For more information on adaptive charging, please also refer to the General Technical Information on our website.

Victron provides a comprehensive Online Training program via the <https://www.victronenergy.com.au/information/training> web portal. Successful completion of this training should be considered essential for system designers and installers, and is recognised with a graduation certificate.

## 3.13. Setup options

### Adaptive three step charging

The Charge Controller is configured for a three step charging process: Bulk – Absorption – Float.

A regular equalization charge can also be programmed.

**Bulk**- During this stage the controller delivers as much charge current as possible to rapidly recharge the batteries.

**Absorption** - When the battery voltage reaches the absorption voltage setting, the controller switches to constant voltage mode. When only shallow discharges occur the absorption time is kept short in order to prevent overcharging of the battery. After a deep discharge the absorption time is automatically increased to make sure that the battery is completely recharged.

Additionally, the absorption period is also ended when the charge current decreases to less than 2A.

**Float** - During this stage, float voltage is applied to the battery to maintain a fully charged state.

### Optional external voltage and temperature sensor

Wired connections are available for battery voltage and temperature sensing. The Solar Charger uses these measurements to optimize its charge parameters. The accuracy of the data it transmits will improve battery charging efficiency, and prolong battery life.

The Smart Battery Sense and other VE.Smart networking features are not currently supported.

### Remote on-off input

Remote L functions as 'allow to charge' in case lithium battery is selected and remote H functions as 'allow to discharge'. Use smallBMS for the RS with Victron lithium batteries.

### Programmable relay

Can be programmed (with a smartphone) to open or close on an alarm, or other events.

## 3.14. Limitations

### Full ESS is not supported

The Multi RS Solar does not yet support grid codes, and therefore does not yet fully support ESS installations. It is not yet known if the current hardware revision will be able to support grid codes, or ESS, via a firmware update in the future. Some ESS features are available, see ESS features topic for more details.

### Assistants and advanced controls are not supported

The Multi RS Solar will not support VE.Configure assistants programming. Customisation and controls are currently limited to what is displayed in the Multi RS Solar settings in VictronConnect. You can use the Multi RS Solar demo mode in VictronConnect to see what features are currently available. We expect additional similar control functionality to be added over time.

### Parallel units are not supported

The Multi RS Solar does not support synchronising AC output sine waves between parallel units. It is not yet known if the current hardware revision will be able to support parallel configurations via a firmware update in the future.

### Maximum charging power limitations

The Multi RS Solar dual tracker can charge the batteries from 3 sources; AC input, DC Solar MPPT, and AC output with AC PV inverter.

- Maximum from AC sources is 88 A DC at 230 VAC and 57.6 VDC, for other voltages see graph below.
- Maximum from DC MPPT tracker is 6kW total, 3kW per tracker for the two tracker model. For the (discontinued) single tracker model, this is 4kW.
- Combined maximum total is 100 A DC

The maximum charge current will vary depending on the battery voltage, and the AC input voltage.

For example, a normal output current variation range is 100A at 48VDC/180VAC to 67A at 60VDC/180VAC.

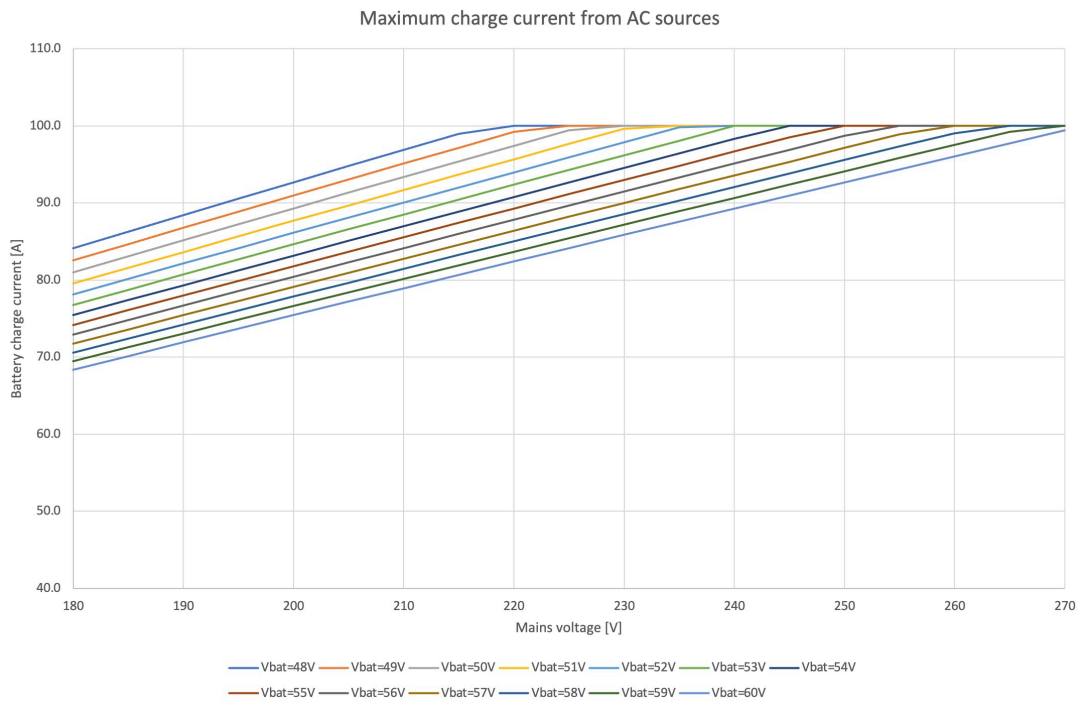

It is normal behaviour that output may reduce below these maximum charge current specifications due to ambient temperature and airflow.





#### AC2 output is not programmable or relay controlled

AC2 output is internally hard wired to the AC input. There is no internal relay contact switch that is able to disconnect, or reconnect it via programming. There is also no delay from when the AC input is connected to when it flows through to the AC2 output.

## 4. Installation

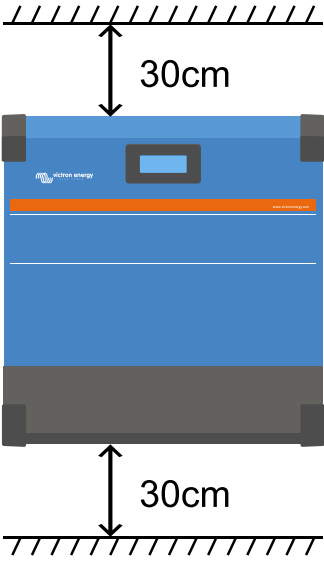
### 4.1. Location of the inverter

Table 1.

 <p>The diagram shows a blue and grey inverter unit mounted vertically. Two double-headed arrows indicate a 30cm clearance above the top of the unit and a 30cm clearance below the bottom of the unit. The unit is shown between two hatched lines representing a ceiling and a floor.</p>	<p>To ensure a trouble free operation of the inverter, it must be used in locations that meet the following requirements:</p> <ol style="list-style-type: none"> <li>Avoid any contact with water. Do not expose the inverter to rain or moisture.</li> <li>Do not place the unit in direct sunlight. Ambient air temperature should be between <math>-20^{\circ}\text{C}</math> and <math>40^{\circ}\text{C}</math> (humidity <math>&lt; 95\%</math> non-condensing).</li> <li>Do not obstruct the airflow around the inverter. Leave at least 30 centimeters clearance above and below the inverter, and preferably installed upright and vertical.</li> </ol> <p>When the unit is running too hot, it will shut down. When it has reached a safe temperature level the unit will automatically restart again.</p>
	<p>This product contains potentially dangerous voltages. It should only be installed under the supervision of a suitable qualified installer with the appropriate training, and subject to local requirements. Please contact Victron Energy for further information or necessary training.</p>
	<p>Excessively high ambient temperature will result in the following:</p> <ul style="list-style-type: none"> <li>Reduced service life.</li> <li>Reduced charging current.</li> <li>Reduced peak capacity, or shutdown of the inverter.</li> </ul> <p>Never position the appliance directly above lead-acid batteries. The unit is suitable for wall mounting. For mounting purposes, a hook and two holes are provided at the back of the casing. The device must be fitted vertically for optimal cooling.</p>
	<p>For safety purposes, this product should be installed in a heat-resistant environment. You should prevent the presence of e.g. chemicals, synthetic components, curtains or other textiles, etc., in the immediate vicinity.</p>

**Try and keep the distance between the product and the battery to a minimum in order to minimise cable voltage losses**

### 4.2. Battery and battery lead requirements

In order to utilize the full capacity of the product, batteries with sufficient capacity and battery cables with sufficient cross section should be used. The use of undersized batteries or battery cables will lead to:

- Reduction in system efficiency.
- Unwanted system alarms or shutdowns.
- Permanent damage to system.

See table for MINIMUM battery and cable requirements.

Model		450/100
Battery capacity Lead-acid		200 Ah
Battery capacity Lithium		50 Ah
Recommended DC fuse		125 A - 150 A
Minimum cross section (mm <sup>2</sup> ) per + and - connection terminal	0 - 2 m	35 mm <sup>2</sup>
	2 - 5 m	70 mm <sup>2</sup>



Consult battery manufacture recommendations to ensure the batteries can take the total charge current of the system. Decision on battery sizing should be made in consultation with your system designer.



Use a torque wrench with insulated box spanner in order to avoid shorting the battery.

**Maximum torque: 14 Nm**

Avoid shorting the battery cables.

- Undo the two screws at the bottom of the enclosure and remove the service panel.
- Connect the battery cables.
- Tighten the nuts well for minimal contact resistance.

### 4.3. Solar array configuration

The Multi RS Solar Dual tracker model must keep the individual tracker inputs isolated from each other. That means one solar PV array per input, do not attempt to connect the same array to multiple tracker inputs.



The maximum rated voltage of the solar charger is 450 V. A PV overvoltage event will damage the solar charger. This damage is not covered by warranty.

In case the PV array is located in colder climates the PV array can output more than its rated Voc. Use the [MPPT sizing calculator on the solar charger product page](#) to calculate this variable. As a rule of thumb, keep an additional 10% safety margin.

The maximum operational input current for each tracker is 13 A.

MPPT PV inputs are protected against reverse polarity, to a maximum short circuit current of 16 A for each tracker.



**BEWARE** that the product warranty will be void if a PV array with a short circuit current larger than 16 A array is connected in reverse polarity.



The Multi RS Solar Dual tracker model must keep the individual tracker inputs isolated from each other. That means one solar PV array per input, do not attempt to connect the same array to multiple tracker inputs.

When the MPPT switches to float stage it reduces battery charge current by increasing the PV Power Point voltage.

The maximum open circuit voltage of the PV array must be less than 8 times the minimum battery voltage when at float.

For example, where a battery has a float voltage of 54.0 volts, the maximum open circuit voltage of the connected array cannot exceed 432 volts.

Where the array voltage exceeds this parameter the system will give a "Over-charge Protection" error and shut down.

To correct this, either increase the battery float voltage, or reduce PV voltage by removing PV panels from the string to bring the voltage back within specification.

#### 4.3.1. Multi RS Solar example PV configuration



This is an example of an array configuration. The decision on the specific array configuration, sizing and design for your system should be made in consultation with your system designer.

**Table 2. PV Array Example**

Panel Type	Voc	Vmpp	Isc	Imp	# of panels	Max String Voltages	Power total
Victron 260W (60 cell)	36.75 V	30 V	9.30 A	8.66 A	#1 - 8 #2 - 8	304 V	4160 W

#### 4.4. MPPT grounding, detection of PV array insulation faults & Earth fault alarm notification

The RS will test for sufficient resistive isolation between PV+ and GND, and PV- and GND.

In the event of a resistance below the threshold (indicating an earth fault), the unit will stop charging and display the error.

If an audible alarm and/or email notification of this fault is required, then you must also connect a GX device (such as the Cerbo GX). Email notifications require an internet connection to the GX device and a VRM account to be configured.

The positive and negative conductors of the PV array must be isolated from ground.

Ground the frame of the PV array to local requirements. The ground lug on the chassis should be connected to the common earth.

The conductor from the ground lug on the chassis of the unit to earth should have at least the cross-section of the conductors used for the PV array.

When a PV resistance isolation fault is indicated, do not touch any metal parts and immediately contact a suitably qualified technician to inspect the system for faults.

The battery terminals are galvanically isolated from the PV array. This ensures that PV array voltages cannot leak to the battery side of the system in a fault condition.

#### 4.5. Cable connection sequence

**First:** Confirm correct battery polarity, connect the battery.

**Second:** if required, connect the remote on-off, and programmable relay, and communications cables

**Third:** Confirm correct PV polarity, and then connect the solar array (if incorrectly connected with reverse polarity, the PV voltage will drop, the controller will heat up but will not charge the the battery).

#### 4.6. Battery connection procedure

Proceed as follows to connect the battery cables:



Use a torque wrench with insulated box spanner in order to avoid shorting the battery. Avoid shorting the battery cables.



Specific care and attention must be taken when making the battery connections. Correct polarity must be confirmed with a multimeter before connection. Connecting a battery with incorrect polarity will destroy the device and is not covered by warranty.

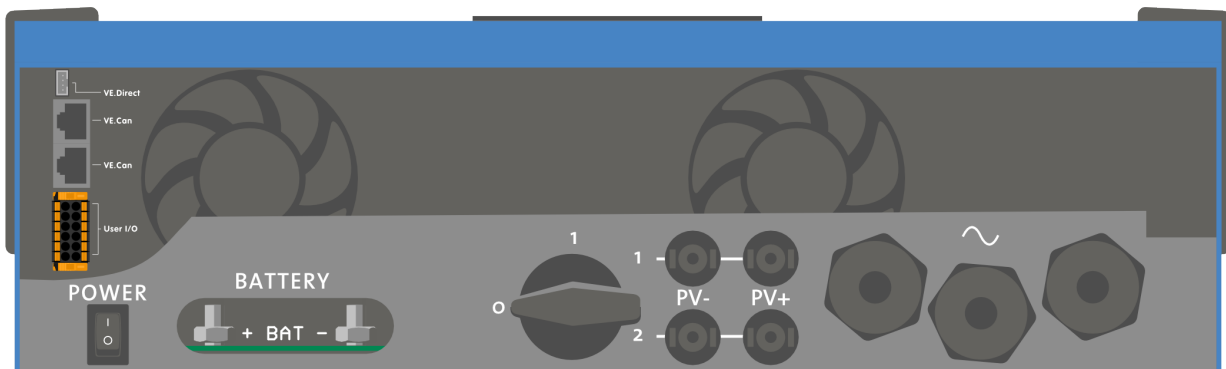

- Undo the two screws at the bottom of the enclosure and remove the service panel.
- Connect the battery cables. First the - cable then the +. Be aware that there may be a spark when making the battery connections.

- Tighten the nuts to the prescribed torques for minimal contact resistance.

## 4.7. Connection of the AC cabling



This is a safety class I product (supplied with a ground terminal for safety purposes). **Its AC input and/or output terminals and/or grounding point on the inside of the product must be provided with an uninterruptible grounding point for safety purposes.** see Appendix A.

In a fixed installation, an uninterruptible grounding can be secured by means of the grounding wire of the AC input. Otherwise the casing must be grounded.

This product is provided with a ground relay (relay H, see Appendix B) that **automatically connects the Neutral output to the chassis if no external AC supply is available.** If an external AC supply is provided, the ground relay H will open before the input safety relay closes. This ensures the correct operation of an earth leakage circuit breaker that is connected to the output.

In a mobile installation (for example, with a shore current plug), interrupting the shore connection will simultaneously disconnect the grounding connection. In that case, the casing must be connected to the chassis (of the vehicle) or to the hull or grounding plate (of the boat). In case of a boat, direct connection to the shore ground is not recommended because of potential galvanic corrosion. The solution to this is using an isolation transformer.

The terminal blocks can be found on the printed circuit board, see Appendix A.

### Do not invert neutral and phase when connecting the AC.

The inverter does **NOT** provide full galvanic isolation between the PV DC input and AC output. Therefore it is possible that DC voltage and current from the DC PV connections could be detected on the AC side.

Full galvanic isolation is provided between PV DC, and Battery DC.

- **AC-out-1** The AC output cable can be connected directly to the terminal block 'AC-out'. From left to right: "N" (neutral) - "PE" (earth) - "L" (phase). With its PowerAssist feature the Multi can add up to 6kVA (that is 6000 / 230 = 26A) to the output during periods of peak power requirement. The Multi RS can provide throughput of up to 50 A to the loads. The AC input relays are limited to 50 A (Multi RS - 2 tracker), and the inverter can contribute up to 25 A continuous at best conditions (when it gets hotter this figure will be reduced). **Torque: 1.2 Nm**



**The AC output terminals must be protected by a fuse or circuit breaker rated at 50 A or less, and cable cross-section must be sized accordingly.** An earth leakage circuit breaker may additionally be required for local compliance.

•

- **AC-out-2** A second output is available that disconnects its load in the event of battery-only operation. On these terminals, equipment is connected that may only operate if AC voltage is available on AC-in-1, e.g. an electric boiler or an air conditioner. The load on AC-out-2 is disconnected immediately when the inverter/charger switches to battery operation. After AC power becomes available on AC-in-1, the load on AC-out-2 will also be reconnected immediately. **Torque: 1.2 Nm.**
- **AC-in** The AC input cable can be connected to the terminal block 'AC-in'. From left to right: "N" (neutral) - "PE" (earth) - "L" (phase active) **The AC input must be protected by a fuse or magnetic circuit breaker rated at 50 A or less, and cable cross-section must be sized accordingly.** If the input AC supply is rated at a lower value, the fuse or magnetic circuit breaker should be down sized accordingly. **Torque: 1.2 Nm.**

## 4.8. VE.Direct

This can be used to connect a PC/laptop to configure the inverter with a VE.Direct to USB accessory. Can also be used to connect a Victron GlobalLink 520 to allow for remote data monitoring.

Note the VE.Direct port on the Multi RS Solar cannot be used to connect to a GX device, and the VE.Can connection must be used instead.

## 4.9. VE.Can

Used to connect to a GX Device, and/or daily-chain communications to other VE.Can compatible products such as the VE.Can MPPT range.

## 4.10. Bluetooth

Used to connect to the device via VictronConnect for configuration.

Note that this Bluetooth interface is not compatible with VE.Smart Networking (i.e Smart Battery Sense).

## 4.11. User I/O

### 4.11.1. Remote on/off connector

The remote on/off connector has two terminals, the "Remote L" and the "Remote H" terminal.

The Multi RS Solar ships with the remote on/off connector terminals connected to each other via a wire link.

Note that for the remote connector to be operational, the main on/off switch on the Multi RS Solar needs to be switched to "on"

The remote on/off connector has two different operational modes:

#### On/off mode (default):

The default function of the remote on/off connector is to remotely switch the unit on or off.

- The unit will switch on if "Remote L" and the "Remote H" are connected to each other (via a remote switch, relay or the wire link).
- The unit will switch off if "Remote L" and the "Remote H" are not connected to each other and are free floating.
- The unit will switch on if "Remote H" is connected to battery positive (Vcc).
- The unit will switch on if "Remote L" is connected to battery negative (GND).

#### 2-wire BMS mode:

This feature can be enabled via VictronConnect. Go to "battery settings" and then to "Remote mode". (see attached image)

Set the remote mode from "on/off" to "2-wire BMS".

In this mode, the "load", "load disconnect" or "allowed to discharge" signal and the "charger", "charger disconnect" or "allowed to charge" signals from a Victron lithium battery BMS are used to control the unit. They respectively turn the inverter off in case discharge is not allowed, and turn the solar charger off if charging is not allowed by the battery.

- Connect the BMS "load", "load disconnect" or "allowed to discharge" terminal to the Inverter RS Smart "Remote H" terminal.
- Connect the BMS "charger", "charge disconnect" or "allowed to charge" to the unit Inverter RS Smart "Remote L" terminal.

### 4.11.2. Programmable relay

Programmable relay which can be set for general alarm, DC under voltage or genset start/stop function. DC rating: 4A up to 35VDC and 1A up to 70VDC

### 4.11.3. Voltage sense

For compensating possible cable losses during charging, two sense wires can be connected directly to the battery or to the positive and negative distribution points. Use wire with a cross-section of 0,75mm<sup>2</sup>.

During battery charging, the charger will compensate the voltage drop over the DC cables up to a maximum of 1 Volt (i.e. 1V over the positive connection and 1V over the negative connection). If the voltage drop threatens to become larger than 1V, the charging current is limited in such a way that the voltage drop remains limited to 1V.

### 4.11.4. Temperature sensor

For temperature-compensated charging, the temperature sensor (supplied with the unit) can be connected. The sensor is isolated and must be fitted to the negative terminal of the battery. The temperature sensor can also be used for low temperature cut-off when charging lithium batteries (configured in VictronConnect).



#### 4.11.5. Programmable analog/digital input ports

The product is equipped with 2 analog/digital input ports, they are labelled AUX\_IN1+ and AUX\_IN2+ on the removable User I/O terminal block.

The digital inputs are 0-5v, and when a input is pulled to 0v it is registered as 'closed'

These ports can be configured in VictronConnect.

Unused: the aux input has no function.

Safety switch: the device is on when the aux input is active.

AC IN connect: only connect to AC input when AUX input is active. An example of when this might be useful is to disable AC input grid charging during an expensive time of use tariff period.

You can assign different functions to each aux input. In case the same function is assigned to both aux inputs then they will be treated as an AND function, so both will need to active for the device to recognise the input.

#### 4.11.6. User I/O terminal diagram

Figure 1.

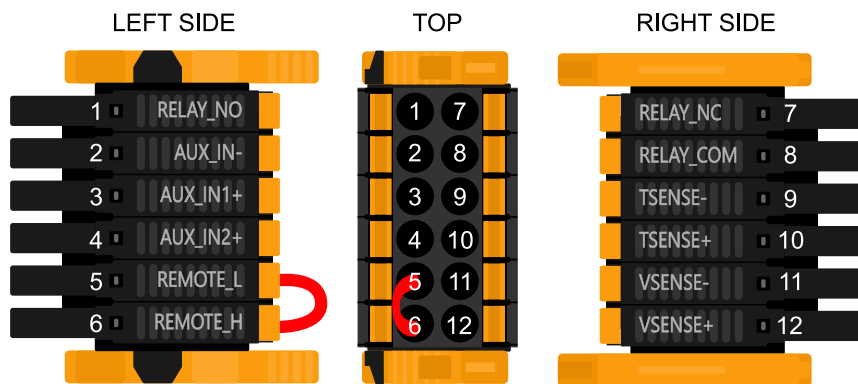

User I/O Connector is located on bottom left side of connection area, diagram shows 3 perspectives. Left Side - Top - Right Side

#### 4.11.7. User I/O functions

Table 3. User I/O Functions - See Installation Section for more details.

Number	Connection	Description
1	Relay_NO	Programmable relay Normally Open connection
2	AUX_IN -	Common negative for programmable auxiliary inputs
3	AUX_IN1+	Programmable auxiliary input 1 positive connection
4	AUX_IN2+	Programmable auxiliary input 2 positive connection
5	REMOTE_L	Remote on/off connector Low
6	REMOTE_H	Remote on/off connector High
7	RELAY_NC	Programmable relay Normally Closed connection
8	RELAY_COM	Programmable relay common negative
9	TSENSE -	Temperature Sensor negative
10	TSENSE +	Temperature Sensor positive
11	VSENSE -	Voltage Sensor negative
12	VSENSE +	Voltage Sensor positive

#### 4.12. Programming with VictronConnect

This guide will help you with the specific elements of VictronConnect that relate to the MPPT Solar Charge Controller.

More general information about the VictronConnect App - how to install it; how to pair it with your device; and how to update firmware, for example - can be found by referring to the overall [VictronConnect manual](#). A list of all VictronConnect compatible devices can be viewed [here](#).

Note: These instructions can apply to different products and configurations, where battery voltage is referred to in these instructions, a 12V battery is used as a reference point. Please multiply the given values by 4 to arrive at settings for an installation configured for the 48V battery system.

#### 4.12.1. Settings



The settings page is accessed by clicking on the Cog icon at the top right of the Home page. The settings page provides access to view or change the settings of the Battery; Load; Streetlight; and Port functions. From this page you can also view Product information such as the Firmware versions installed on the MPPT Solar Charger.

#### 4.12.2. Battery settings

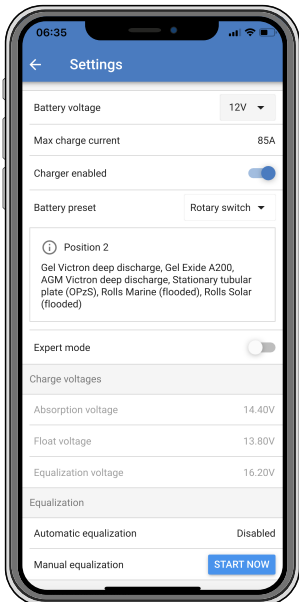

##### Battery voltage

The RS is fixed to 48V, and is only available for 48V systems.

##### Max charge current

Allows the user to set a lower maximum charge current.

##### Charger enabled

toggling this setting turns the Solar Charger off. The batteries will not be charged. This setting is intended only for use when carrying-out work on the installation.

## Charger settings - Battery preset

Battery preset allows you to select the battery type; accept factory defaults; or enter your own preset values to be used for the battery charge algorithm. The Absorption voltage, Absorption time, Float voltage, Equalisation voltage and Temperature compensation settings are all configured to a preset value - but can be user-defined.

User-defined presets will be stored in the preset library - in this way installers will not have to define all the values each time they are configuring a new installation.

By selecting *Edit Presets*, or on the Settings screen (with expert mode on or not), custom parameters can be set as follows:

### Absorption voltage

Set the absorption voltage.

### Adaptive absorption time

Select with adaptive absorption time or fixed absorption time will be used. Both are better explained below:

*Fixed absorption time:* The same length of absorption is applied every day (when there is enough solar power) by using the maximum absorption time setting. Be aware that this option can result in overcharging your batteries, especially for lead batteries and system with shallow daily discharges. See your battery manufacturer for recommended settings. *Note:* make sure to disable the tail current setting to make the same absorption time every day. The tail current could end absorption time sooner if the battery current is below the threshold. See more information on the tail current setting section below.

*Adaptive absorption time:* The charge algorithm can use an adaptive absorption time: it automatically adapts to the state of charge in the morning. The maximum duration of the absorption period for the day is determined by the battery voltage as measured just before the solar charger begins operation each morning (12 V battery values used - Multiply Battery voltage by 4 for 48V):

Battery voltage Vb (@start-up)	Multiplier	Maximum absorption times
Vb < 11.9 V	x 1	06:00 hours
> 11.9 V Vb < 12.2 V	x 2/3	04:00 hours
> 12.2 V Vb < 12.6 V	x 1/3	02:00 hours
Vb > 12.6 V	x 2/6	01:00 hours

The multiplier is applied to the maximum absorption time setting and this results in the maximum duration of the absorption period used by the charger. The maximum absorption times shown in the last column of the table are based on the default maximum absorption time setting of 6 hours.

### Maximum absorption time (hh:mm)

Set the absorption time limit. Only available when using a custom charge profile.

Enter the time value in the notation hh:mm, where hours are between 0 and 12; and minutes are between 0 and 59.

### Float voltage

Set the float voltage.

### Re-bulk voltage offset

Set the voltage offset that will be used over the float voltage setting that will determine the threshold that the charge cycle will restart.

E.g.: For a Re-bulk voltage offset of 0.1V and a float voltage setting of 13.8 V, the voltage threshold that will be used to restart the charge cycle will be 13.7 V. In other words, if the battery voltage drops below 13.7 V for one minute, the charge cycle will restart.

### Equalization voltage

Set the equalization voltage.

### Equalization current percentage

Set the percentage of the Max charge current setting that will be used when equalisation is performed.

### Automatic Equalization

Set-up the frequency of the auto equalize function. Available options are between 1 and 250 days:

- 1 = daily
- 2 = every other day
- ...

- 250 = every 250 days

Equalization is typically used to balance the cells in a lead battery, and also to prevent stratification of the electrolyte in flooded batteries. Whether (automatic) equalization is necessary, or not, depends on the type of batteries, and their usage. Consult your battery supplier for guidelines.

When the Automatic equalization cycle has initiated, the charger applies an equalization voltage to the battery as long as the current level stays below the equalization current percentage setting of the bulk current.

#### Duration of the Automatic equalization cycle

In the case of all VRLA batteries and some flooded batteries (algorithm number 0, 1, 2 and 3) automatic equalization ends when the voltage limit (maxV) has been reached, or after a period equal to (absorption time/8) - whichever comes first.

For all tubular plate batteries (algorithm numbers 4, 5 & 6); and also for the user-defined battery type, automatic equalization will end after a period equal to (absorption time/2).

For the Lithium battery type (algorithm number 7), equalization is not available.

When an automatic equalization cycle is not completed in one day, it will not resume the next day. The next equalization session will take place according to the interval set in the 'Auto Equalization' option.

The default battery type is a VRLA battery and any user-defined battery will behave as a tubular plate battery with regard to equalization.

#### **Equalisation stop mode**

Set how the equalisation will end. There are two possibilities, first is if the battery voltage reaches the equalisation voltage and the second is on fixed time, where the maximum equalisation duration is used.

#### **Maximum equalisation duration**

Set the maximum time that the equalisation phase will last.

#### **Tail current**

Set the current threshold that will be used to finish absorption phase before the maximum absorption time expires. When the battery current gets below the tail current for one minute, the absorption phase will end. This setting can be disabled by setting it to zero.

#### **Temperature compensation**

Many types of battery require a lower charge voltage in warm operating conditions, and a higher charge voltage in cold operating conditions.

The configured coefficient is in mV per degree Celsius for the whole battery bank, not per cell. The base temperature for the compensation is 25°C (77°F), as shown in the chart below.

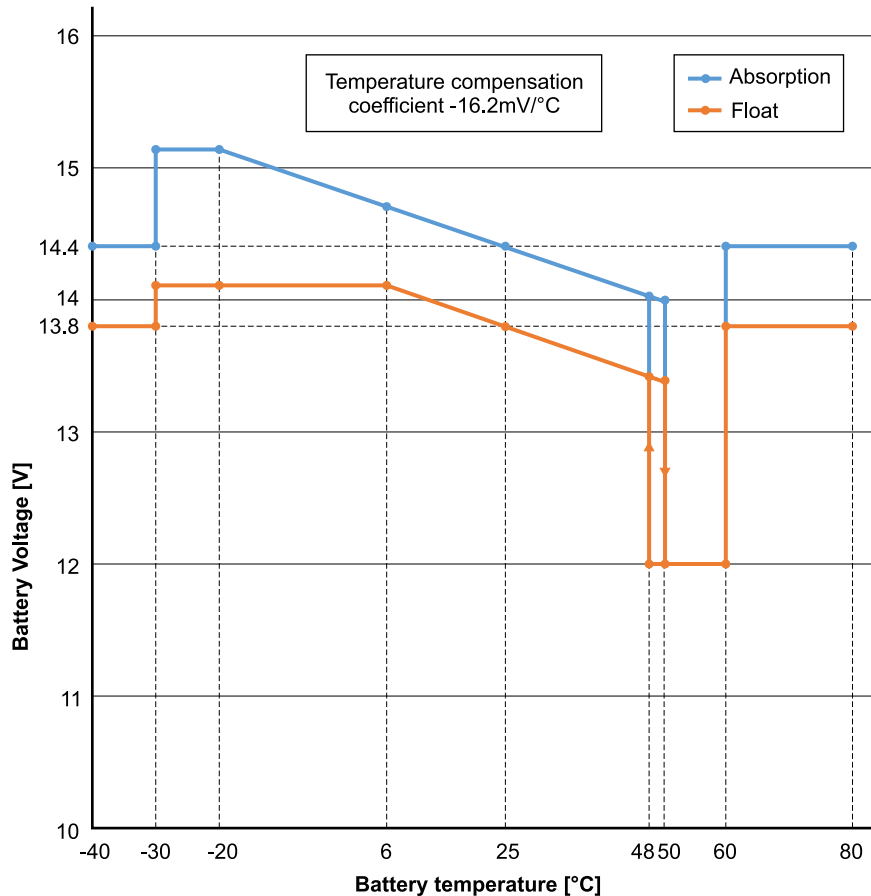

With a temperature sensor installed to the User I/O connection block; the actual battery temperature will be used for compensation; throughout the day.

#### Low temperature cut-off

This setting can be used to disable charging at low temperatures as required by Lithium batteries.

For Lithium Iron Phosphate batteries this setting is preset at 5 degrees Celsius, for the other battery types it is disabled. When creating a user defined battery the cut-off temperature level can be adjusted manually.

#### Manual Equalization - Start now

Selecting 'Start now' on 'Manual equalisation' allows manual initiation of an Equalization cycle. To allow the charger to equalize the battery properly use the manual equalize option only during absorption and float periods, and when there is sufficient sunlight. Current and voltage limits are identical to the automatic equalize function. The duration of the equalisation cycle is limited to a maximum of 1 hour when triggered manually. Manual equalization can be stopped at any time by selecting 'Stop Equalize'.

### 4.12.3. Generator programming

The Multi RS Solar has a tolerance for irregularities on the AC input like fast frequency changes or voltage changes to improve reliability when connecting to generators.

Using a generator with the Multi RS Solar requires firmware version v1.11 or later.

If using a generator; it is recommended to adjust these settings;

1. VictronConnect -> Settings -> General -> Enable 'Moderate generator load changes'.
2. VictronConnect -> Settings -> Grid -> Disable the 'UPS function'.

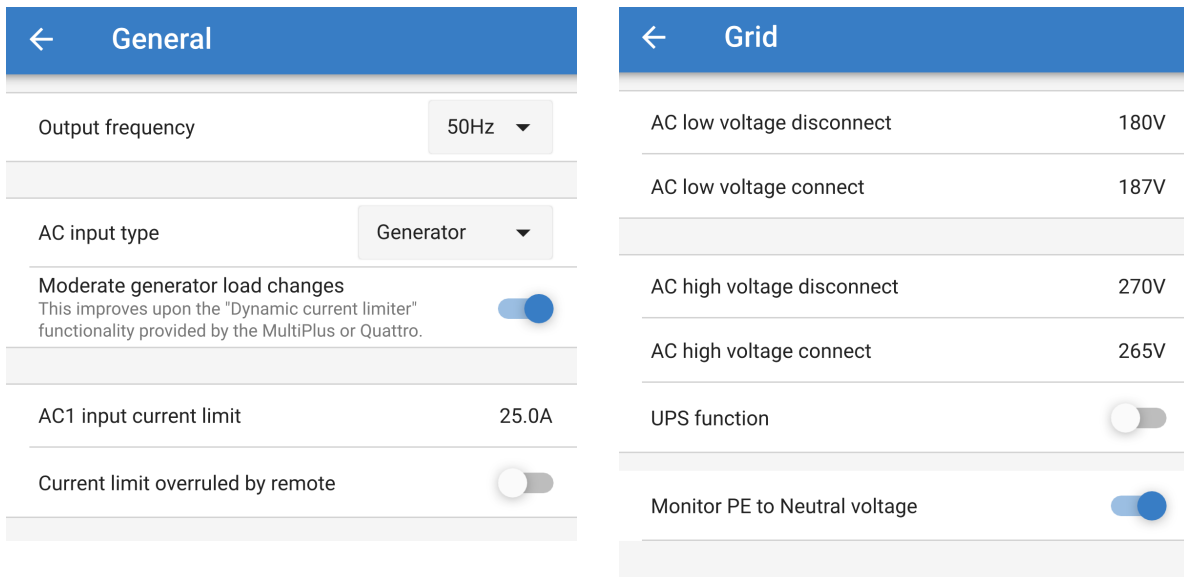

The 'moderate generator load changes' setting enables the inverter/charger to absorb sudden load changes and slowly transfer them to the generator. This reduces speed and voltage variations in the generator.

The 'UPS function' restricts the acceptance of an AC input to a very precise sine wave so that in the event of an interruption in the AC supply it is possible to maintain an apparent continuity of supply to the loads. This is incompatible with most generators and should be disabled when using a generator to improve reliable acceptance of the AC supply.

#### Limitations

The Multi RS Solar includes limited relay control options such as open/close on a programmable low battery voltage. For more advanced generator control programming functionality, please use a GX device (such as the Cerbo GX).

See [Limitations \[7\]](#) chapter for additional charging power limitations.

#### 4.12.4. UPS behaviour

The UPS feature enables a faster transfer to inverter mode when the AC input supply is interrupted.

This function is enabled by default, and should be disabled when using a generator (or grid with irregular sinewave).

The setting is located in VictronConnect -> Settings -> Grid -> UPS function.

The 'UPS function' limits the acceptance of an AC input to a very precise sine wave so that in the event of an interruption in the AC supply it is possible to maintain an apparent uninterrupted continuous power supply to the loads.

The typical response time at a sudden drop of the grid voltage is 6 ms. If the AC input drop starts around the zero crossing of the sine the response time is about 8ms. This is including the response time of the relay.

In case the inverter is able to supply sufficient power into the AC input the response time for the ac in-relay to open might take longer. However the load is still supplied continuously with at least >160Vrms. The AC input relay is always opened within 200ms.

Victron Energy does not recommend the use of this product in life support applications where failure or malfunction of Victron Energy's product can be reasonably expected to cause the failure of the life support device or to significantly affect its safety or effectiveness.

#### 4.12.5. AC Input Control

The AC Input Control can be set up in numerous ways, for example, the Multi will disconnect from the grid when the batteries are full enough and/or the AC load is not too big. The Multi will disconnect from the grid most of the time. It will only let the grid in when the batteries are empty or when you are running a big AC load. You now can use the grid like you would use a backup generator.

The mechanism behind the AC Input Control is the opening or closing the Multi's internal AC input relay.

This feature is not enabled by default.

The normal function of this relay is to open as soon as the grid or generator is not there. For example, during a blackout or when a generator is off. This is a safety action. The relay prevents energy feeding into the grid during a blackout or when the generator is off.

This relay can also be setup to purposefully ignore the grid. It will still perform its normal safety action but it can open and disconnect from the grid under more situations. It can ignore the grid when the batteries are still full enough. Now DC solar power can be prioritized and the grid will be used like a backup generator

### When can the grid be controlled?

The AC input relay can be programmed to selectively ignore the grid, while looking at two parameters: It can look at battery voltage and/or at AC load parameters.

#### The grid is ignored when the batteries are full enough. The grid is let in when the batteries are empty:

- This setting can be used to charge the batteries from the grid should the batteries get too empty. This can occur, for example, at night or during a long period of bad weather.
- In this scenario the Multi will look at the battery voltage. It will let the grid in when the battery voltage is too low, for a certain amount of time. It will ignore the grid as soon as the battery voltage has increased above a certain level, for a certain amount of time.
- The multi can also disconnect the grid on battery state of charge.

#### The grid is ignored when the AC loads are low. The grid is let in when the AC loads are high:

- This setting can be used to allow grid in when the AC load is higher than the Multi rating. This will prevent the Multi going into overload. This setting can also be used for large loads that you do not want to run from the battery.
- In this scenario the Multi will look at the AC load. As soon as it sees that the load is above a certain level, for a certain amount of time, the Multi will let the grid in. The multi will stop letting the grid in as soon as it sees that the AC load has dropped below a certain level, for a certain amount of time.

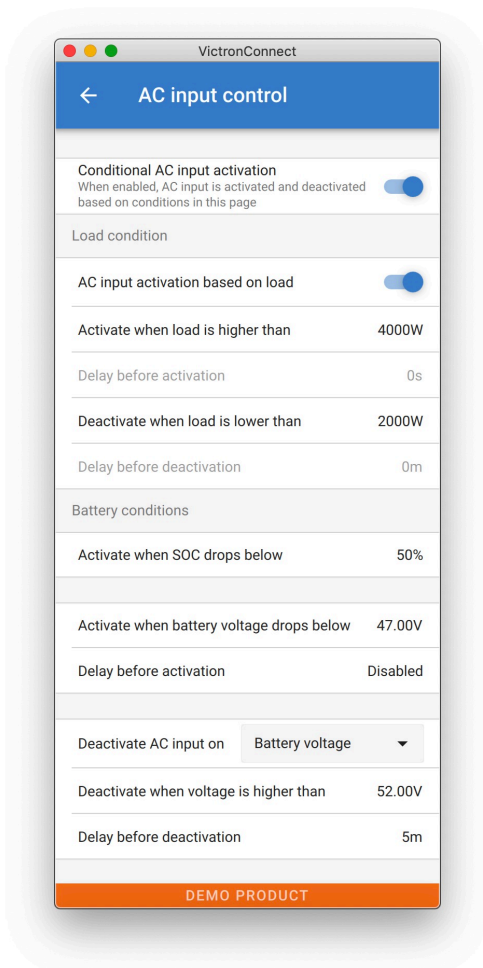

### Conditional AC input activation

Enables the use of AC Input Control to modify the operation of the feedback relay.

### Load Conditions

This setting can be used to allow grid in when the AC load is higher than the Multi rating. This will prevent the Multi going into overload. This setting can also be used for large loads that you do not want to run from the battery.

In this example the grid will not be ignored when the load exceeds 4000 Watts, with no delay.

Do not ignore AC input means that the grid is accepted because the AC input relay is closed. The grid will be ignored when the load drops below 2000 W.

Ignore AC means that the grid is ignored because the AC input relay is open.

Depending on your load, if the AC input relay is opening and closing frequently, add a time delay before activation and deactivation.

AC input activation based on load

Activate when load is higher than W

Delay before activation T

Deactive when load is lower than W

Delay before deactivation T

### Battery Conditions

This setting can be used to charge the batteries from the grid should the batteries get too empty. This can occur, for example, at night or during a long period of bad weather.

In this example, the grid is not ignored when the battery voltage is less than 47 Volt. Do not ignore AC input means that the grid is accepted because the AC input relay is closed.

The grid will be ignored again when the battery voltage exceeds 52 Volts for more than 5 minutes.

Ignore AC means that the grid is ignored because the AC input relay is open. Apart from “battery voltage”, there are two other options to choose from: “bulk finished” or “absorption finished”.

Choosing “absorption finished” is a good way to ensure the batteries are getting a full charge every now and then. But it can lead to a higher electricity bill. The absorption charge stage of a lead-acid battery is much less efficient than the bulk stage.

This could be a reason to choose the “bulk finished” option. At the end of the bulk charge stage a lead-acid battery is about 85% full.

For more information about bulk and absorption please see the Victron Energy book “Energy Unlimited”, page 25. Follow this link: <https://www.victronenergy.com.au/orderbook>

It is also possible to let grid in when the batteries fall below a certain state of charge.



In a system that contains additional charge sources external to the Multi, or DC loads, the “state of charge” option should only be used if you also have a GX device in the system. And the GX device is connected to both the Multi and the external MPPT solar charger(s) and/or a BMV battery monitor. See this link for more information: <https://www.victronenergy.com/media/pg/CCGX/en/configuration.html#UUID-3d1bea6f-30a0-7d84-8ba6-dab25033ba16>

## 4.12.6. Inverter Modes

### On / Off Menu

The On/Off menu in VictronConnect provides several modes of operation.

#### ON

This will turn the unit ON via the software toggle, this is the default mode of operation.

Using this mode requires that the physical hardware ON/OFF switch is set to ON.

Turning the physical hardware switch OFF will turn the unit off, and cannot be overridden by the software ON switch.

#### OFF

This will turn the unit OFF via the software control.

The physical hardware switch set to ON will be overridden by the software OFF setting.

The unit will turn OFF if the physical hardware switch is set to ON, but the software switch is set to OFF.

### Inverter Only

Inverter only mode disconnects the AC input from the grid by opening the AC input relay.

The solar charger is still active in this mode.

### Charger Only

Charger only mode turns off the Inverter providing AC voltage to the AC output.

The charger will charge the batteries from the AC input in this mode.



The solar charger is still active in this mode.

### Pass Through

This mode closes the AC input relay and passes through AC voltage from the AC input to the AC output while the inverter/charger remains off.

The solar charger remains active.

### 4.12.7. ESS controls

The factory default operation when an AC input is connected to a Multi RS is that the charger will begin charging the batteries up to the maximum AC input current and charge current limits. We call this factory default mode "Keep batteries charged".

In some cases the user may want to only use the AC input to charge the battery when necessary, and instead allow the batteries to discharge to provide for the loads and recharge from solar.

To enable this flexibility there are several possible configuration options.

It is possible to use the '[Conditional AC input connection](#)', this will physically disconnect the AC input relay, disconnecting the AC input supply unless the programmed parameters are met.

When the parameters are met, then the AC input relay will close, connecting the AC input and the Multi RS will charge the battery from the AC input.

If it is preferred to keep the AC input relay closed, and the AC input connected, but not use it to continuously charge the battery, there is another option called ESS Optimised mode.

#### Keep Batteries Charged

This is the factory default mode selected. This setting will keep the batteries fully charged. Utility grid failure is then the only time battery power is used - as a backup. Once the grid is restored, the batteries will be recharged either from the grid or from solar panels - when available.

Even you choose to normally run in an optimised mode, it may be useful to use this mode if you're expecting a storm that might disrupt the AC supply and you want to make sure the batteries are fully charged before the power goes out.

#### Optimised

This mode will keep the AC input relay closed, but will only use the AC input supply to maintain the battery at the 'Minimum discharge SOC' setting.

When there is more PV power than is required to run loads, the excess PV energy is stored in the battery. That stored energy is then used to power the loads at times when there is a shortage of PV power.

This mode also maintains PowerAssist. This means if the load is larger than the inverter is able to provide it will use power from the AC input to support it.

The percentage of battery capacity used for self-consumption is configurable. When utility grid failure is extremely rare it could be set to 100%. In locations where grid failure is common - or even a daily occurrence - you might choose to use just 20% of battery capacity and save 80% of the storage capacity to provide for the next grid failure.

#### BatteryLife

BatteryLife refers to an algorithm that will automatically increase the minimum SOC if the battery is not getting regularly recharged.

Once the battery is getting fully charged again, the BatteryLife algorithm will reduce the minimum SOC back down again until it reaches the minimum SOC set by the user in the VictronConnect ESS menu.

#### Sustain

This mode is not user selectable.

When the battery voltage hits the shutdown level or the BMS indicates that the battery is empty, the unit will change to 'SUSTAIN' mode and allow a trickle charge mode (5A) from the AC input.

#### Limitations

Please note that the ESS implementation for the VE.Can Multi RS is managed differently to that for the VE.Bus products. No assistant is required to be installed, ESS settings are available out of the box.

It is not yet possible to adjust the available ESS settings via the ESS menu of the GX. The ESS menu of the GX will display 'No ESS Assistant found'.

It is also not possible to change ESS settings via the controls menu of VRM.

Multi RS ESS settings can only be changed via VictronConnect, and the ESS menu in the settings there.

This can be done locally via Bluetooth or VE.Direct to USB, and also remotely if the system is connected via a GX device to VRM, with Remote VictronConnect.

Grid Code compliance is not yet available for the Multi RS. So export is not allowed by software.

### 4.13. Connecting to AC PV inverters

The Multi includes a built in AC PV inverter detection system. When there is a feedback of AC PV (a surplus) from the AC-out connection port, the Multi will automatically enable an AC output frequency adjustment.

While no further configuration is required, it is important that the AC PV inverter is configured correctly to respond to the frequency adjustment by reducing its output.

Note the 1:1 rule of AC PV inverter size to Multi size, and minimum battery sizing applies. More information about these limitations are available in the [AC Coupling manual](#), and this document is required reading if using an AC PV inverter.

The frequency adjustment range is not configurable, and includes a built in safety margin. Once the absorption voltage is reached, the frequency will increase. So it is still essential to include a DC PV component in the system for complete battery charging (i.e. float stage).

It may be possible to adjust the power output response to various frequencies on your AC PV inverter.

The default configuration has been tested and works reliably with the Fronius MG50/60 grid code configuration.

### 4.14. Large systems - 3 phase



3 phase systems are complex. We do not support or recommend that untrained and/or inexperienced installers work on these size systems.

If you are new to Victron, please start with small system designs, so that you become familiar with the necessary training, equipment and software required.

It is also recommended to hire an installer that has experience with these more complex Victron systems, for both the design and the commissioning.

Victron is able to provide specific training for these systems to distributors via their regional sales manager.



VE.Can 3 phase networking differs from VE.Bus. Please read the documentation in full, even if you have experience with large VE.Bus systems.

Mixing different models of Inverter RS (ie. the model with Solar and without Solar) is possible. However mixing Inverter RS with Multi RS is not currently supported.

#### DC and AC wiring

Each unit needs to be fused individually on the AC and DC side. Make sure to use the same type of fuse on each unit.

The complete system must be wired to a single battery bank. We do not currently support multiple different battery banks for one connected 3 phase system.

#### Communication wiring

All units must be daisy chained with a VE.Can cable (RJ45 cat5, cat5e, or cat6). The sequence for this is not important.

Terminators must be used at either ends of the VE.Can network.

The temperature sensor can be wired to any unit in the system. For a large battery bank it is possible to wire multiple temperature sensors. The system will use the one with the highest temperature to determine the temperature compensation.

#### Programming

All settings need to be set manually by changing the settings in each device, one by one. For now synchronising settings to all devices is not supported by VictronConnect.

There is a partial exception to this - changing the AC output voltage will temporarily be pushed to other synchronised devices (to prevent undesired power flow imbalance via the AC output). However this is not a permanent settings change and still needs to be manually set on all devices if you wish to change the AC output voltage.

Charger settings (voltage and current limits) are overridden if DVCC is configured and if a BMS-Can BMS is active in the system.

#### System Monitoring

It is strongly recommended that a [GX Family Product](#) is used in conjunction with these larger systems. They provide highly valuable information on the history and performance of the system.

System notifications are clearly presented and many additional functions are enabled. Data from [VRM](#) will greatly speed support if it is required.

### 4.15. 3 phase installation

The Multi RS Solar supports single phase, and three phase configurations. It does not currently support split phase.

The factory default is for stand alone, single unit operation.

If you wish to program for three phase operation, it requires at least 3 units.

The maximum supported system size is 3 units in total, with a single unit on each phase.

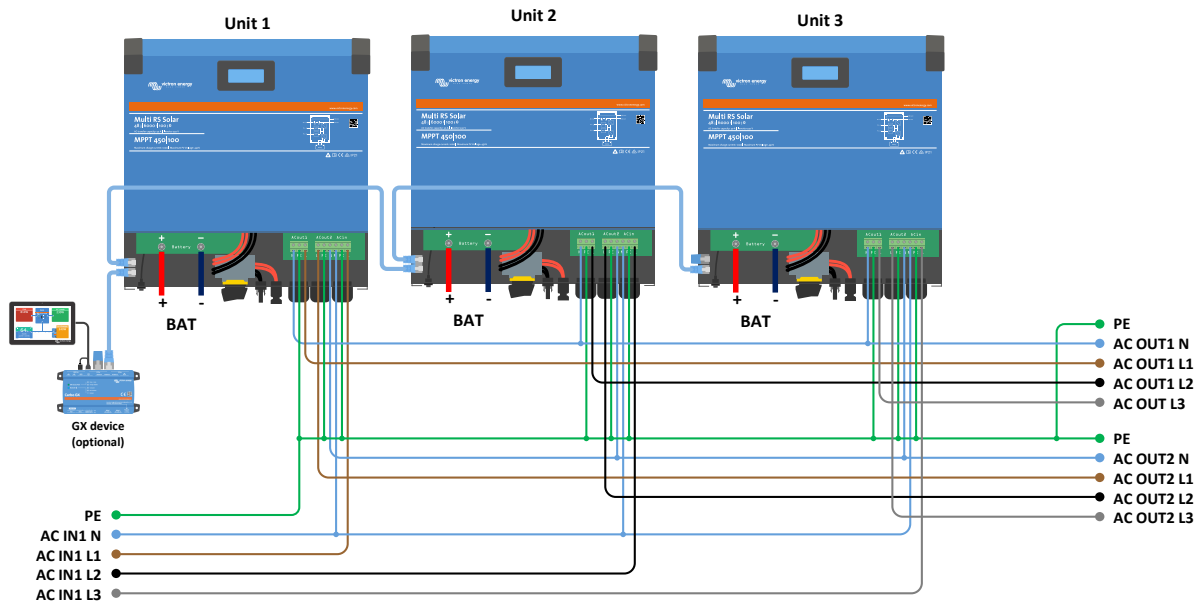

They must be connected to each other via VE.Can connections, with a VE.Can terminator (supplied) at the start and the end of the bus.

Once the units are connected to the battery and via VE.Can they will need to be configured.

**Delta configurations not supported**

For units in 3 phase configuration: Our products have been designed for a star (Y) type three phase configuration. In a star configuration all neutrals are connected, a so called: "distributed neutral".

We do not support a delta ( $\Delta$ ) configuration. A delta configuration does not have a distributed neutral and will lead to certain inverter features not operating as expected.

**4.16. 3 phase programming**

In order to configure a 3 phase system the Multi RS Solar will need to be **correctly installed**, and running firmware version v1.13 or later.

Configuring a system for three phase or single phase is done in VictronConnect in the System menu.

AC output power will be disconnected for a few seconds when switching System configuration modes. Make sure the system is configured **BEFORE** connecting inverter AC output to the loads.

The factory default setting is Standalone (a single unit).

To set up a 3 phase system, connect to the first unit in VictronConnect, change the System setting to Three phase, and then select the correct phase for that unit (L1, or L2, or L3)

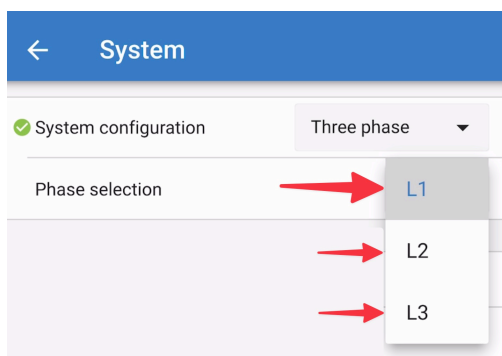

You will need to do this individually for each unit.

It is recommended to physically label the front of each unit, as well as give it a custom name in VictronConnect to match the physical label.

The screenshot shows the 'System' configuration page in VictronConnect. At the top, there is a blue header with a back arrow and the word 'System'. Below this, there are several settings:

- System configuration:** Three phase (dropdown menu)
- Phase selection:** L1 (dropdown menu)
- Prevent CAN network islanding:** A toggle switch that is turned on (blue).
- Number of inverters in the system:** 3
- Minimum number of inverters to start:** 1
- Continue with missing phase:** A toggle switch that is turned off (grey).
- System instance:** 0

#### Prevent CAN network islanding toggle

This feature determines what the system does in case of a broken CAN connection between the RS units, and enables the 'Number of inverters in the system' setting below. Default is enabled.

If three Multi RSEs are configured in three phase, each individual unit will only continue to work if it sees at least one other unit. This feature is only relevant in combination with the "Continue with missing phase" feature.

#### Number of inverters in the system

Enter the total number of RS units installed in the system. This should be set to 3 for a 3 phase Multi RS system.

In case a CAN connection is broken between two units the network is split into segments, this setting is used to determine the largest and shut down the smaller segment to prevent them from continuing on their own unsynchronised.

Note that setting the option "Continue with missing phase" to disabled overrules this behavior in such a way that it always ensures that all three phases must be powered at all times, so a broken CAN connection in a 3 phase setup will shut down all units.

#### Minimum number of inverters to start

Minimum number of inverters that must be present per phase when starting the system.

Set to 1 means that all 3 units in a 3 phase Multi RS system must be present to start.



These System settings must be programmed individually, and set correctly on all connected inverters for synchronised operation.

#### Note on redundancy and continuous output during firmware updates

A three phase system can be firmware updated without losing power on the AC output.

Make sure that there is stable AC input available when starting the update and the unit currently being updated will switch to AC-passthru mode.

The AC synchronisation mechanism used for 3 phase has a 'protocol' version embedded.

Units can work together even with different firmware versions, as long as they are running the same protocol version.

This allows for continuous uninterrupted supply even when updating firmware, as the units will individually update one at a time, while others continue to synchronise and provide the stable AC output.

If Victron needs to change the 'protocol' version number, it will be clearly noted in the firmware change log. Always read this before updating.

In the event that there are multiple protocol versions running on the same VE.Can bus, all units will indicate error #71 until they are all updated to the same version.

#### Continue with Missing Phase

It is possible to configure the system so that if one unit is offline (for example due to it being physically switched off or a firmware update in case there is no grid connection to allow pass-thru), the other units can continue to operate and provide AC output power to their respective phases.

By default, the 'continue with missing phase' is disabled. Switching one unit off with the physical switch will make that unit switch off. If the unit is one of three units that are in three phase, then the others will also turn off as well.

If configured with 'Continue with missing phase' enabled, and minimum number of units is sufficient, then output to the other phases will continue even though its down to less phases than configured.

The 'Continue with missing phase' configuration option SHOULD NOT be enabled if there are specific three phase loads connected that require all three synchronised phases to operate (such as a three phase electric motor).

In that situation maintain the default 'disabled' setting for "Continue with missing phase".



Attempting to run a three phase load with only two phases operating could result in damage to your appliance.



If you have configured the system to continue to operate with a missing phase, and there is an issue with the VE.Can communications between the units (such as the wire being damaged), then the units will continue to operate, but will not be synchronising their output wave forms.

### System Instance

Units with the same instance number work together on the AC side.

Changing the System instance setting allows multiple groups of Inverters to be on the same VE.Can bus, but not synchronised, and segmented into different AC outputs, without interference.

Continue with the same programming settings on the rest of the units.

### Known Issues

- The 'UPS function' is too sensitive in 3 phase operation compared to stand-alone operation. Disable the 'UPS function' in case the Multi disconnects frequently from the AC input.
- Charge currents are not yet balanced across the 3-phases when the charger is in voltage-controlled mode.

## 5. Operation

### 5.1. Device display

The Multi RS Solar has an LCD screen that displays operational information.

#### Inverter:

Inverter state, Power output, Frequency and AC Voltage

```
Inverter:      ***
  410W 50.0Hz 230V
- Inverting -
```

```
AC input:     ***
-5000W 50.0Hz 230V
ACIN1 relay closed
```

#### Battery:





Battery Power (charging shows positive number, discharging shows negative number), Current, DC voltage, Temperature (\*), State-of-charge (\*) and Time-to-go (\*). Battery state (e.g. discharging, bulk, absorption, float, etc).

```
Battery:      ***
 1748W 54.12V 32A
 26°C 98%
- Bulk -
```

(\*) These items are only visible if the data is available.

```
Solar:        ***
1812W 178.9V 10.1A
Today 0.29 kWh
Total 0.3 kWh
```

```
AC Solar:     ***
2500W 50.0Hz
Today 9.89 kWh
Total 551.3 kWh
```

	Communicating on any interface (e.g., Bluetooth, VE.Can, etc.)
	Bluetooth Enabled, Icon colour changes when connected
	(Blinking) Error or Warning
	Inverter Active



Battery, fill corresponds with voltage, blinks when empty

## 5.2. History - Thirty-day graphic



(The fragmented square icon (top left) allows you to toggle between 'portrait' and 'landscape' screen presentations.)

A summary of activity for the last 30 days is presented graphically. Swipe the bar left or right to show any of the previous 30 days.

The daily log shows:

- **Yield:** The energy converted for that day.
- **P max:** The maximum power recorded during the day.
- **V max:** The highest voltage from the PV array during the day.

Clicking on any day/bar in the graph will expand the information to show charge-status times - both as hrs/m; and also as a percentage of the 'charge' day. This graphic provides an at-a-glance representation of how much time your charger is spending in each of three modes: Bulk / Absorption / Float.

Tip! You can use the charge times to see if the PV array is properly sized for your requirements. A system which never reaches 'Float' may need more panels; or perhaps the load could be reduced?

It is possible to export the history as a comma separated file (.csv) by clicking the three connected dots at the top right of the history screen:

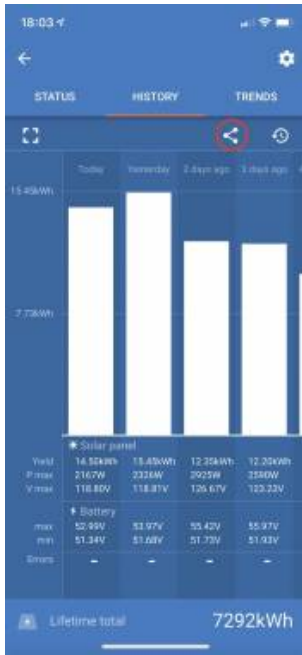

This is an example of the exported data for 3 of 30 days:

Days ago	Date	Yield(MWh)	Consumption(MWh)	Max. PV power(W)	Max. PV voltage(V)	Min. battery voltage(V)	Max. battery voltage(V)	Time in bulk(m)	Time in absorption(m)	Time in float(m)	Last error	2nd last error	3rd last error	4th last error
0 3/22	5520	190	1159.13	86.93	50.06	57.96	345	0	0	0	0	0	0	0
1 2/22	7280	50	1160.17	87.01	49.61	58.01	455	120	71	0	0	0	0	0
2 1/22	6400	130	1167.8	87.58	50.12	58.39	400	120	91	2	0	0	0	0
3 28/22	3950	160	1161.42	87.11	49.41	58.07	247	120	85	0	0	0	0	0
4 27/22	6870	270	1156.12	86.71	50.34	57.81	430	120	65	0	0	0	0	0
5 26/22	5450	50	1169.5	87.71	49.56	58.47	341	120	74	0	0	0	0	0
6 25/22	7170	50	1159.24	86.94	49.89	57.96	448	120	67	0	0	0	0	0
7 24/22	6890	290	1154.23	86.57	49.85	57.71	431	120	81	0	0	0	0	0
8 23/22	6870	110	1155.14	86.64	49.54	57.76	429	120	79	0	0	0	0	0
9 22/22	4140	70	1158.62	86.9	50.23	57.93	259	120	65	0	0	0	0	0
10 21/22	7070	220	1154.57	86.59	50.05	57.73	442	120	102	0	0	0	0	0
11 20/22	5980	240	1166.48	87.49	49.79	58.32	374	120	114	0	0	0	0	0
12 19/22	6630	200	1162.79	87.21	49.93	58.14	414	120	63	0	0	0	0	0
13 18/22	6470	220	1154.59	86.59	50	57.73	405	120	86	0	0	0	0	0
14 17/22	4660	50	1165.6	87.42	49.83	58.28	291	120	91	0	0	0	0	0
15 16/22	4710	10	1164.31	87.32	50.36	58.22	294	120	66	0	0	0	0	0
16 15/22	5930	180	1171.3	87.85	50.19	58.56	371	120	72	0	0	0	0	0
17 14/22	5270	70	1161.25	87.09	50.12	58.06	329	120	118	0	0	0	0	0
18 13/22	6000	90	1170.66	87.8	50.03	58.53	375	120	69	0	0	0	0	0
19 12/22	5460	140	1163.38	87.25	49.54	58.17	341	120	60	0	0	0	0	0
20 11/22	6530	230	1155.58	86.67	49.69	57.78	408	120	71	0	0	0	0	0
21 10/22	4780	190	1167.97	87.6	49.53	58.4	299	120	94	0	0	0	0	0
22 9/22	6750	280	1156.98	86.77	50	57.85	422	120	63	0	0	0	0	0
23 8/22	6350	220	1159.76	86.98	50.07	57.99	397	120	86	0	0	0	0	0
24 7/22	6470	290	1162.95	87.22	50.2	58.15	405	120	109	0	0	0	0	0
25 6/22	7280	270	1168.69	87.65	50.02	58.43	455	120	109	0	0	0	0	0
26 5/22	4770	270	1166.14	87.46	50.06	58.31	298	120	107	0	0	0	0	0
27 4/22	6800	140	1157.28	86.8	49.63	57.86	425	120	118	0	0	0	0	0
28 3/22	4430	270	1169.64	87.72	50.33	58.48	277	120	96	0	0	0	0	0
29 2/22	6780	130	1152.93	86.47	50.31	57.65	424	120	93	0	0	0	0	0

### Battery Voltage

The first figure shows the maximum battery voltage for the day ...the figure below is the minimum battery voltage.

### Errors

Shows the number of errors (if any) for the day, to see the error codes click on the orange point. See [MPPT Solar Charger Error Codes](#). (You may need to slide the display on your device up to see the errors.)

### Total

This shows the total energy converted by the installation and is not re-settable.

### Since Cleared

This shows how much energy has been converted by the installation since the last reset.

## 5.3. Protections and automatic restarts

### 5.3.1. Overload

Some loads like motors or pumps draw large inrush currents during start-up. In such circumstances, it is possible that the start-up current exceeds the over current limit of the inverter. In this case the output voltage will quickly decrease to limit the output current of the inverter. If the over current limit is continuously exceeded, the inverter will shut down for 30 seconds and then automatically restart. After three restarts followed by overload within 30 seconds of restarting, the inverter will shut down and remain off. To restart normal operation, disconnect the load, Switch Off the inverter, then switch it On.



### 5.3.2. Low battery voltage thresholds (adjustable in VictronConnect)

The inverter will shut down when the DC input voltage drops below the low battery shutdown level. After a minimum shutdown time of 30 seconds, the inverter will restart if the voltage has risen above the low battery restart level.

After three shut down and restarts, followed by a low battery shutdown within 30 seconds of restarting, the inverter will shut down and stop retrying based on the low battery restart level. To override this and restart the inverter, switch it Off, and then On, and limit loads to enable recharging of the battery with solar energy.

See the Technical Data table for default low battery shut down, restart and charge detect levels. They can be adjusted with VictronConnect (computer or app).

Additionally another external MPPT or battery charger can also be used to recharge the battery to reach the Restart Voltage or Charge Detect voltage level. !!! If using the allow to charge signal functionality, it must remain above the minimum voltage, so if the battery is completely dead it will not allow charging to start. In this case, you can temporarily disable this function in VictronConnect to allow charging to resume, then enable it again.

See the Technical Data table for default low battery shut down and restart levels. They can be changed with VictronConnect (computer or app). Alternatively Dynamic Cut-off can be implemented, see <https://www.victronenergy.com/live/ve.direct:phoenix-inverters-dynamic-cutoff>

### 5.3.3. High battery voltage

Reduce DC input voltage and/or check for a faulty battery- or solar-charger in the system. After shutting down due to a high battery voltage, the unit will first wait 30 seconds and then retry operation as soon as the battery voltage has dropped to acceptable level.

### 5.3.4. High temperature

A high ambient temperature or enduring high load may result in shut down to over temperature. The inverter will restart after 30 seconds. The inverter will continue to try and resume operation, and will not stay off after multiple retries. Reduce load and/or move inverter to better ventilated area.

## 6. Troubleshooting Guide - MPPT

### 6.1. Troubleshooting and support

For unexpected behaviour or suspected product faults, refer to this chapter.

Start by checking the common issues described here. If the problem persists, contact the point of purchase (Victron dealer or distributor) for technical support.

If you're unsure who to contact or if the point of purchase is unknown, refer to the [Victron Energy Support webpage](#).

### 6.2. The solar charger is unresponsive

The solar charger is unresponsive (inactive) if the display is not illuminated, there is no charging activity, and it is not communicating with the VictronConnect app via Bluetooth or the VE.Direct port.

If the unit is active, the display is active or can communicate with the VictronConnect app via Bluetooth or the VE.Direct port.

For the solar charger to be active, it must be powered either via the battery or the PV terminals (or both), and the unit must be switched on.

**In case the solar charger is not active, follow these steps to try to remedy this situation:**

- Ensure that the unit has been switched on via its main switch, located at the underside of the unit on the left-hand side.
- Ensure that the PV switch has been switched on. It is located at the underside of the unit, in the middle.
- Once switched on, the solar charger will activate as soon as one (or both) of the battery or PV terminals are powered.

The voltage of the battery or the PV terminals needs to be above the minimum voltage as specified in the technical specifications chapter.

For instructions on how to check the voltage, see the below "Battery and PV terminal voltage check" procedure.

**Battery and PV terminal voltage check procedure:**



**WARNING** – A dangerous voltage can be (or is) present on the solar charger electrical terminals; only perform this procedure if you are a trained electrical technician.

- Use a multimeter set to DC voltage mode.
- Measure the voltage between the positive and negative battery terminals.
- Measure the voltage between the positive and negative PV terminals.
- Confirm that the battery or the PV voltage is at least above the minimum voltage as specified in the technical specifications chapter.

**If the battery and PV terminals do not have a sufficient voltage:**

- Check the battery and PV supply cables.
- Check the fuses and circuit breakers.
- Check if all connections are tight.
- Is the battery voltage sufficiently high enough? If not, charge the battery with an auxiliary charger.
- Is the PV voltage sufficiently high enough? Is there a problem with the PV array, or is it night?

**If the unit remains unresponsive after confirmation of a sufficient battery or PV voltage:**

- Consider the solar charger to be faulty.

### 6.3. Solar charger is off

If the solar charger is off, the VictronConnect app will indicate this. To find out the reason why the solar charger is off, click on the "Why is the charger off?" text and a pop-up window will appear with an explanation and possible remedies.

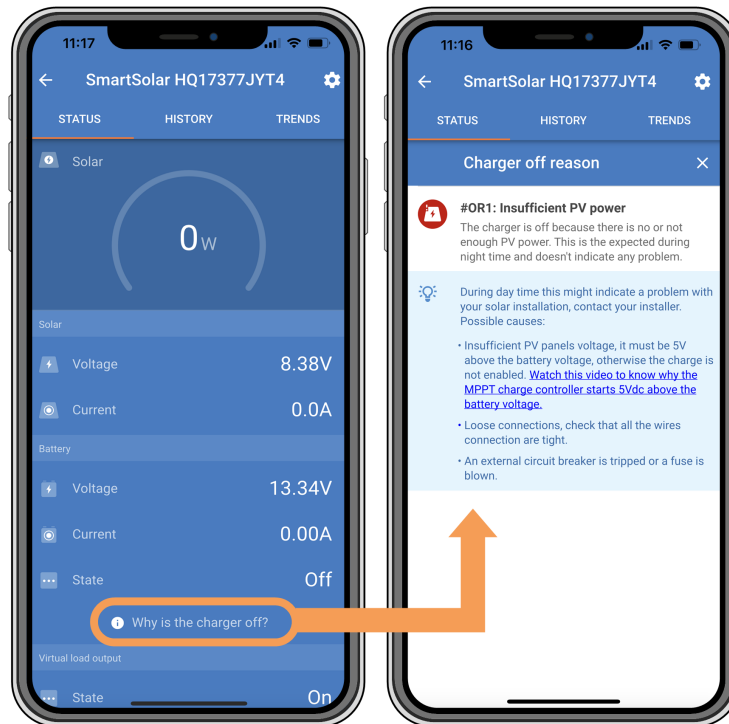

VictronConnect app – Why is the charger off?

#### Reasons why the solar charger is off:

- There is insufficient PV power.
- The settings being edited on an external display
- The charger is disabled in the settings.
- The charger is disabled by remote or BMS.
- Low lithium battery temperature.

#### 6.3.1. PV voltage too low

The solar charger will commence charging when the PV voltage is a minimum of 120V. Once charging has commenced, the PV voltage must remain higher than 80V for charging to continue.

#### Check the PV and battery voltage



**WARNING:** Depending on the solar charge controller model, the PV voltage can be up to 450Vdc.

Voltages above 50V are generally considered to be dangerous. Check your local electrical safety regulations as to the exact regulations. Dangerous voltages can only be handled by a qualified technician.

1. Use the VictronConnect app, a solar charger display or a GX device to check the battery voltage and PV voltage.
2. In case the above step is not possible, measure the battery and PV voltages at the solar charger terminals using a multi meter instead.
3. Compare both voltages. The PV voltage needs to be a minimum of 120V to start up, and also 80V to continue operation.

#### Causes of zero or low PV voltage:

##### Not enough solar irradiance into the solar panels:

- Night.
- Cloud cover or bad weather.
- Shading – see this [shading blog story](#) for more information.
- Dirty panels.

- Seasonal differences.
- Wrong orientation and/or inclination.

Problems with a panel or panel wiring:

- Mechanical or electrical issue with an individual panel (or multiple panels).
- Wiring problems.
- Blown fuses.
- Open or faulty circuit breakers.
- Splitters or combiners issues, or these are used in an incorrect way.

PV array design issues:

- Solar array wiring configuration mistake - not enough panels in a series string.

Reverse PV polarity:

- The positive and negative have been swapped when connected to the controller, read next paragraph: "Reverse PV polarity".

### 6.3.2. Reverse PV polarity

As long as the unit is installed within the published specifications, the PV input is protected internally against PV reverse polarity.

In the case of reverse PV voltage, the solar charger will not indicate an error.

The only way to detect reverse PV voltage is by the following signs:

- The controller is not charging the batteries, the charge current is zero.
- The controller is getting hot.
- The PV voltage is zero, or close to zero.

If this is the case check for reverse polarity using a multimeter by ensuring that the positive PV cable is connected to the positive PV terminal, and the negative cable is connected to the negative terminal.



Measuring PV voltage at the PV terminals of a solar charger should only be performed by an electrical technician.

## 6.4. Solar charger externally controlled

The solar charger can be controlled by an external device. The external device can stop or reduce the charge current to the battery. This is not a fault but expected behaviour.

Managed batteries or an inverter/charger with an external control system like, for example, an ESS system, can control the solar charger via a GX device. The battery dictates if charging is allowed, and when charging is allowed, what charge voltage and currents are used. If external control is active this will be displayed in the VictronConnect app and also on the GX device.

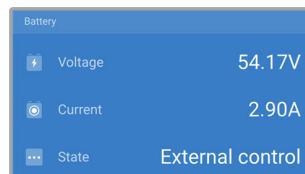

*The VictronConnect app indicating that the charger is externally controlled.*

## 6.5. Batteries are not charged

This chapter describes situations where the charger is active, but the batteries are not being charged.

The VictronConnect app indicates that the charger is active and the charge voltage is correct, but the charge current is zero, or close to zero.



The VictronConnect app shows a close to zero charge current.

There are a number of reasons why this can happen, namely:

- The battery is full, and no more current is needed.
- The solar charging is not connected to the battery (cable, fuse or circuit breaker issues).
- Wrong configuration (voltage or current set too low).
- The charger is externally controlled (ESS or DVCC). See the [Solar charger externally controlled \[33\]](#) chapter.
- The battery temperature is too high and temperature-compensated charging is active or set incorrectly, see the [Wrong temperature compensation setting \[38\]](#) chapter.
- Reverse PV polarity.
- Reverse battery polarity.

### 6.5.1. Battery is full

Once the battery is full the solar charger will stop charging or will greatly reduce the charge current.

This is especially the case when at the same time the DC loads in the system are not consuming any power from the battery.

To find out what the state of charge (SoC) of the battery is, check the battery monitor (if present), or alternatively, check what charge stage the controller is in. Also, observe that the solar cycle is (briefly) progressing through these charge stages at the beginning of the daily charge cycle:

- Bulk stage: 0-80% SoC.
- Absorption stage 80-100% SoC.
- Float or storage stage: 100% SoC.

Be aware that it can also be possible that the solar charger thinks the battery is full, while in reality, the battery is not full. This can occur when the charge voltages have been set too low, causing the solar charger to prematurely switch to the absorption or float stage. For more information see the [Battery settings too low \[35\]](#) chapter.

### 6.5.2. Battery not connected

For the solar charger to be able to charge the battery it needs to be connected to the battery.

It might look like the battery is connected because the solar charger is able to operate without a battery connected and the VictronConnect app will show a battery voltage and a charge stage, but the charge current is zero or close to zero.

**Possible causes of a disconnected battery:**

- Loose or missing battery cables.
- Loose cable connections or badly crimped cable terminals.

- A blown (or missing) fuse in the battery supply cable.
- Open (or faulty) circuit breaker in the battery supply cable.
- Missing or incorrectly wired battery cables.

### Battery voltage check

1. Use the VictronConnect app, a connected display or a GX device to read the solar charger battery voltage or use a multimeter to measure the battery voltage at the terminals of the controller.



Measuring battery voltage at the battery terminals of a solar charger should only be performed by a qualified electrical technician.

2. Use a multimeter to measure the voltage at the battery terminals.

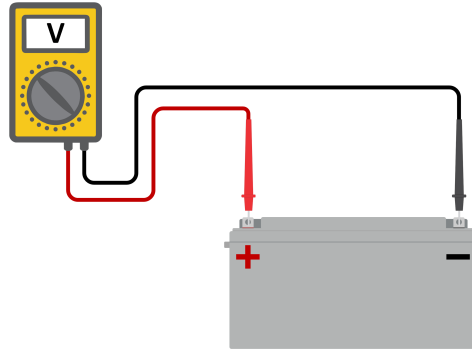

3. Compare the two voltages.
4. If the battery voltage and the controller voltage are different, then investigate why this is. Follow the path from the controller to the battery to investigate what could be the cause.

### Battery connection check

1. Check and verify that all cabling is connected correctly, and that no wiring mistakes have been made.
2. Check if all cable connections are tight while taking maximum torque levels into consideration.
3. Check if all cable lugs or cable terminals have been crimped correctly.
4. Check fuses and/or circuit breakers.



If a blown fuse is found, first ensure that the battery polarity has been correctly wired before replacing the fuse. See next paragraph for more information on reverse battery polarity.

### 6.5.3. Battery settings too low

#### Battery charge voltages set too low:

The battery will not be charged if the battery charge voltage settings are set at a voltage lower than the battery voltage.

- In the VictronConnect app, navigate to the solar charger "Settings" menu and select the "Battery" menu.
- Check if the charge voltages are correct and that they correspond with the battery manufacturer's recommendation.

#### Charge current set to zero:

The battery will not be charged if the "Max. charge current" is set to zero or close to zero.

- In the VictronConnect app, navigate to the solar charger "Settings" menu and select the "Battery" menu.
- Check if the "Max. charge current" value is set correctly and corresponds with the battery manufacturer's recommendation.

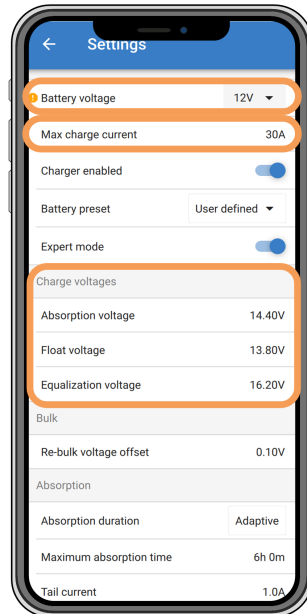

*VictronConnect app, showing battery (system) voltage, charge current and charge voltages settings.*

#### 6.5.4. Reverse battery polarity

Reverse polarity is when the positive and the negative battery cable have been accidentally swapped. The battery negative has been connected to the positive solar charger terminal and the battery positive has been connected to the negative solar charger terminal.



Be aware that a red cable or positive labelled cable might not necessarily mean that the cable is indeed a positive cable. A wiring or labelling mistake could have been made during installation of the solar charger.

The solar charger is not protected against reverse battery polarity and any damage caused by this is not covered under warranty.



Always verify the battery polarity before reconnecting the battery wires to the solar charger.

#### 6.5.5. Reverse PV polarity

As long as the unit is installed within the published specifications, the PV input is protected internally against PV reverse polarity.

In the case of reverse PV voltage, the solar charger will not indicate an error.

The only way to detect reverse PV voltage is by the following signs:

- The controller is not charging the batteries, the charge current is zero.
- The controller is getting hot.
- The PV voltage is zero, or close to zero.

If this is the case check for reverse polarity using a multimeter by ensuring that the positive PV cable is connected to the positive PV terminal, and the negative cable is connected to the negative terminal.



Measuring PV voltage at the PV terminals of a solar charger should only be performed by an electrical technician.

## 6.6. Batteries are undercharged

This chapter deals with possible reasons why the solar charger is not sufficiently charging the batteries and the steps you can take to check or remedy the situation.

**Some signs of undercharged batteries:**

- The batteries take too long to charge.

- The batteries are not fully charged at the end of the day.
- The charge current from the solar charger is less than expected.

### 6.6.1. Insufficient solar

Check if the solar charger reaches the float charge stage each day.

To investigate look at the history tab in the VictronConnect app. The histogram displays how long the batteries have been charged in the Bulk, Absorption and Float stage each day, for the last 30 days. If you click on one of the histogram columns you will see a breakdown of the charge stages.

You can use the charge times to see if the PV array is properly sized for your requirements.

A system that never reaches the float stage could have the following issues:

- Not enough solar panels.
- Too much load.
- A problem with the array causing it to have a reduced power output.
- For more potential reasons see paragraph: "PV power or yield less than expected".

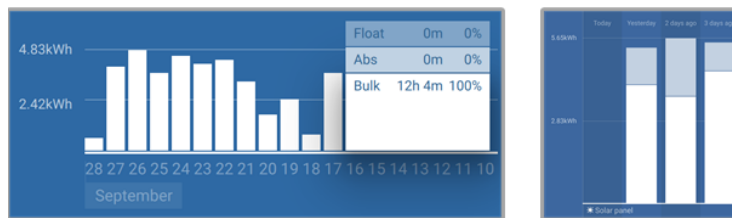

*System spending all its time in bulk with breakdown of charge stages - System in bulk and absorption*

### 6.6.2. Too much DC load

The solar charger does not only charge the batteries, it also provides power for the system's loads.

The battery will only be charged when the power available from the PV panels exceeds the power being drawn by the loads in the system, like lights, fridge, inverter, and so on.

If the system battery monitor is correctly installed and configured you can see how much current is going in (or out) of the battery and the solar charger will tell you how much current the solar array is generating.

A positive sign alongside the current reading means that current is flowing in to the battery, while a negative sign means that current is being drawn from the battery.

### 6.6.3. Battery cable voltage drop

If there is a voltage drop over the battery cables, the solar charger will output the correct voltage, but the batteries will receive a lower voltage which can potentially lead to undercharged batteries. A voltage drop in excess of 2.5% is unacceptable.

**The voltage drop will cause the following:**

- Battery charging will take longer.
- The battery receives a too-low charge voltage.
- There is a loss of charge power.
- The battery cables heat up.

**The voltage drop is caused by the following:**

- Battery cables with insufficient cross-sectional area.
- Badly crimped cable lugs or terminals.
- Loose terminal connections.
- Bad or loose fuse(s).

For more information on cabling issues and voltage drop see the [Wiring unlimited book](#).



### Battery cable voltage drop check

This check must be performed while the charger is charging with a full current. Typically best done in the morning. Use the VictronConnect app to check the output current.

1. Measure the voltage on the battery terminals of the solar charger using the VictronConnect app or a multimeter.
2. Measure the battery voltage on the terminals of the battery using a multimeter.

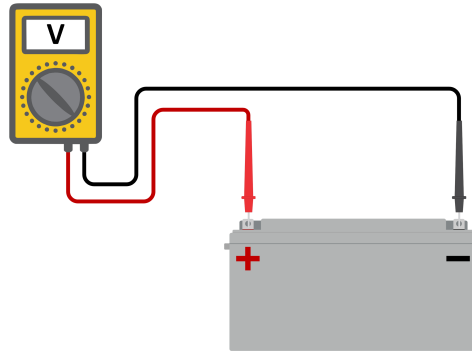

3. Compare the two voltages to see if there is a voltage difference.

#### 6.6.4. Wrong temperature compensation setting

If the temperature compensation coefficient is set incorrectly, the batteries can be undercharged or be overcharged. The temperature compensation can be set via VictronConnect or via a display.

To find out the correct temperature compensation coefficient setting for your battery, refer to the battery documentation. When in doubt use the default value of  $-64.80\text{mV}/^{\circ}\text{C}$  for lead acid batteries and disable the temperature compensation setting for lithium batteries.

### 6.7. Batteries are overcharged



Batteries that are being overcharged are very dangerous! There is a risk of battery explosion, fire or acid leakage. Do not smoke, create sparks or have open flames in the same room as where the batteries are located.



**Overcharging batteries will cause battery damage and can be caused by:**

- Incorrect charge voltage settings.
- Applying equalisation while the battery is not suitable for equalisation.
- High current and undersized batteries.
- Battery faults.
- Too high current, while the battery is not accepting charge anymore because of aging or prior mistreatment.

#### 6.7.1. Battery charge voltages too high

If the battery charge voltages are set too high this will cause the batteries to overcharge.

Check if all the battery charge voltages (absorption and float) are set correctly.

The charge voltages have to match the recommended voltages as stated in the battery manufacturers documentation.

#### 6.7.2. Battery unable to deal with equalization

During equalization, the battery charge voltage will be quite high and if the battery is unsuitable to be equalized, the battery will be overcharged.

Not all batteries can be charged with equalization voltages. Check with the battery manufacturer if the battery you are using needs a periodic equalizing charge.

Generally speaking, sealed batteries as well as lithium batteries don't need and therefore should not be equalized.

### 6.7.3. Battery old or faulty

A battery that is at the end of its service life or has been damaged by incorrect use, can be prone to being overcharged.

A battery contains a number of cells that are connected in series. When a battery is old or has been damaged, a likely scenario is that one of these cells is not operational anymore.

When the faulty battery is charged, the damaged cell will not accept charge and the remaining cells will receive the broken cell's charge voltage and thus will be overcharged.

To fix this, replace the battery. In case of multiple battery system replace the whole battery bank. It is not recommended to mix batteries of different ages in one battery bank.

It is hard to tell what has exactly happened to a battery during its lifetime. The solar charger will keep 30 day of battery voltage history. If the system also contains a battery monitor, or if the system is connected to VRM, the battery voltages and the cycle history of the battery can be accessed. This will give a complete picture of the battery history and it can be determined if the battery is near the end of its service life or has been abused.

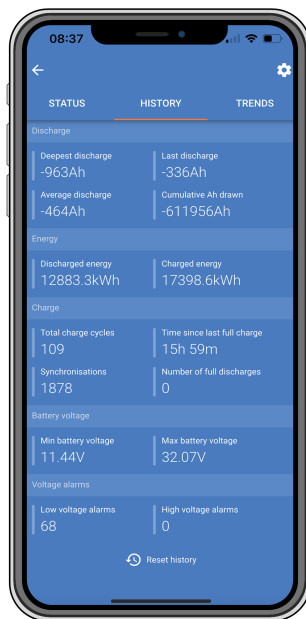

*VictronConnect app showing battery monitor history*

#### To check if the battery is close to its cycle life:

1. Find out how many charge and discharge cycles the battery has been subjected to. Battery lifetime correlates to the number of cycles.
2. Check how deep the battery has been discharge on average. A battery will last for less cycles if deeply discharged, compared to more cycles if discharged less deep.
3. Refer to the battery data sheet to find out how many cycles at what average discharge the battery is capable of. Compare this with the battery history and determine if the battery is near the end of its service live.

#### To check if the battery has been misused:

1. Check if the battery has been totally discharged at all. Total and very deep discharge will damage a battery. Check the battery monitor setting history on the VRM portal. Look for the deepest discharge, the lowest battery voltage and the number of full discharges.
2. Check if the battery has been charged with a too high voltage. Very high charge voltage will damage the battery. Check the maximum battery voltage and the high voltage alarms in the battery monitor. Check if the measured maximum voltage has exceeded the battery manufacturer recommendations.

## 6.8. PV problems

This chapter deals with the remaining solar problems that were not already discussed in the earlier chapters.

### 6.8.1. PV yield less than expected

Check the solar charger history in the VictronConnect app. Check the total maximum power (Pmax) for each day. Does this match the array power?

To find the potential solar yield per day for a specific PV array size in a specific geographical location, use the MPPT sizing calculator on the [solar charge controller product page](#).

These are some of the reasons why the array is generating less power than expected:

- Low sun angle, seasonal differences or morning/evening.
- Cloud cover or bad weather.
- Shading from trees or buildings.
- Dirty panels.
- Incorrect orientation and/or inclination.
- Broken or faulty solar panel(s).
- Issues with wiring, fuses, circuit breakers, wiring voltage drop.
- Bad splitters or combiners, or these are used in an incorrect way.
- Part of the PV array not working.
- PV array design issues.
- Solar array configuration mistakes.
- The batteries are too small, or getting older, and have a reduced capacity.



*VictronConnect app history Pmax reading.*

### 6.8.2. Full rated output not reached

There are a few reasons why the solar charger is not reaching its full rated output.

Some of these reasons have already been explained in the the chapter: “The batteries take too long to charge, are undercharged or charge current less than expected”. Some additional reasons are explained in this paragraph.

#### **PV array too small**

If the PV array power rating is less than the solar charger nominal power rating, the solar charger cannot output more power than the connected solar array can provide.

#### **Temperature above 40°C**

When the solar charger heats up, eventually the output current will derate. When the current is reduced naturally the output power will reduce as well.

The controller is operational up to 60°C, with a full rated output up to 40°C.

In case the solar charger heats up quicker than expected, pay attention to the way it has been mounted. Mount it in such a way that the generated heat can dissipate.

Ideally mount the solar charger on a vertical surface with the terminals facing downwards.

If the solar charger is located in a closed enclosure, such as a cabinet, make sure that cold air can enter and hot air can leave the enclosure. Mount vents in the enclosure.

For very hot environments consider mechanical air extraction or provide air conditioning.

### 6.8.3. Mixed PV panel types

It is not recommended to connect a mix of different PV panel types to the same solar charger.

Only use solar panels that are the same brand, type and model.

### 6.8.4. MC4 connectors wrongly connected

For a detailed explanation of how to connect MC4 connectors, MC4 splitters and MC4 combiners, see the [Wiring unlimited book](#), chapter: "Solar panels".

### 6.8.5. PV connections burned or melted

Burned or melted PV cables or connections are generally not covered under warranty. In most case this is due to any of the following reasons:

#### Solar cable

- Cables with rigid core wire or rigid strands used.
- Cables where the core wire has been soldered.
- Cable too thin - remember that the current will be higher when the PV voltage is lower. For more information on cable thickness see the [Wiring Unlimited book](#).

#### MC4 terminals

- Current has exceeded 30A per connector pair.
- Incorrectly crimped MC4 connectors.
- Bad quality MC4 connectors used

### 6.8.6. Optimisers cannot be used

Do not use solar panels with optimisers together with the solar charger.

Nearly all optimisers contain an MPPT or other tracking mechanisms and this interferes with the MPPT algorithm in the solar charger.

### 6.8.7. Ground current

The system should not have a current flowing to ground under normal operation.

If a ground current is detected, first investigate all the equipment connected to that system and check for ground faults.

Next, check how many connections to ground the system has. There should only be a single point in the system connected to ground. This should be at the battery.

For more information on system grounding, see the "System grounding" chapter in the [Wiring Unlimited book](#).

The Multi RS Solar connection between PV DC and battery DC is fully galvanically isolated.

The connection between PV DC and AC output is not isolated.

### 6.8.8. PV voltage too high

The PV voltage should never exceed the maximum rated PV voltage of the solar charger. The maximum PV voltage rating is printed on the front or on the side of the housing of the controller, and in the product specification sheets.

The solar charger stops charging if the PV voltage exceeds the maximum rated PV voltage. At the same time, it will display an overvoltage error #33, and will fast blink its absorption and float LED.

Charging will not recommence until the PV voltage has dropped 5V below the rated maximum voltage.

When investigating a high voltage issue, also look at the history of the VictronConnect app, solar charger display or GX device. Check the highest PV voltage for each day (Vmax) and also look for past overvoltage warnings.



*VictronConnect app: screenshot of an Error #33 and a screenshot of the history indicating an error*

Check the open circuit voltage (Voc) rating of the PV array. Ensure that it is less than the maximum rated voltage of the solar charger. Use the MPPT sizing calculator on the [solar charger product page](#). In case the PV array is located in cold climates or if the night temperature drops close to or below 10°C the PV array can output more than its rated Voc. As a rule of thumb, keep an additional 10% safety margin.

An overvoltage event can damage the solar charger, depending on how much the maximum PV voltage was exceeded. This damage is not covered by warranty.

## 6.9. Communication problems

This chapter describes issues that might arise when the solar charger is connected to the VictronConnect app, other Victron devices or third-party devices.

### 6.9.1. VictronConnect app



For operational issues of the VictronConnect app, like the app will not run or is unable to connect to the solar charger, see the general [VictronConnect manual](#).

### 6.9.2. Bluetooth

Please note that it is highly unlikely that the Bluetooth interface is faulty. The problem is most likely caused by something else. Use this chapter to quickly rule out some of the common causes of Bluetooth issues.

For a full troubleshooting guide see the [VictronConnect manual](#).

- **Check if Bluetooth is enabled**

It is possible to enable/disable Bluetooth in the product settings. To re-enable:

Connect to the solar charger via the VE.Direct port.

Navigate to the controller settings and then to "product info".

Re-enable Bluetooth.

- **Check if the controller is powered-up**

Bluetooth is active as soon as the solar charger is powered-up.

- **Check that Bluetooth is in range**

In open space the maximum Bluetooth distance is about 20 meters. In a build-up area, inside a house, a shed, a vehicle or a boat this distance can be a lot less.

- **The Windows VictronConnect app does not support Bluetooth**

The Windows version of the VictronConnect app does not support Bluetooth. Use an Android, iOS or macOS device instead. Or alternatively connect using a [VE.Direct to USB interface](#).

- **The controller is missing in the VictronConnect app device list**

Some steps to try to resolve this issue are:

Press the orange refresh button at the bottom of the VictronConnect app device list and check if the solar charger is now listed. Only one phone or tablet can be connected to the solar charger at any given time. Make sure no other devices are connected and try again.

Try to connect to another Victron product, does this work? If that also does not work, there probably is an issue with the phone or tablet.

Rule out any issues with the phone or the VictronConnect app by using another phone or tablet and try again.

If still unresolved, refer to the [VictronConnect app manual](#).

- **PIN code lost**

If you have lost the PIN code, you will need to reset the PIN code to its default PIN code. This is done in the VictronConnect app:

Navigate to the device list of the VictronConnect app.

Enter the solar charger's unique PUK code as printed on its product information sticker.

Click on the option symbol next to the solar charger listing.

A new window will open which allows you to reset the PIN code back to its default: 000000.

- **How to communicate without Bluetooth**

In case Bluetooth is not functional, turned off or unavailable, the VictronConnect app can still communicate via the unit's VE.Direct port. Or, if the unit is connected to a GX device, the VictronConnect app can communicate via VRM. For more information see the [VictronConnect app](#) chapter.

### 6.9.3. VE.Direct port

These are not common and if this occurs it is probably due to one of these issues listed in this paragraph.

**Physical cable connector or data port issues** Try a different VE.Direct cable and see if the unit will now communicate. Is the connector inserted properly and deep enough? Is the connector damaged? Inspect the VE.Direct port, are there bent pins? If this is the case, use long nose pliers to straighten the pins, while the unit is unpowered.

**VE.Direct TX port issues** Check the "TX port function" setting in VictronConnect. Does the set function match the application it is being used in. To test if the TX port is operational check its functionality using a [TX digital output cable](#).

**VE.Direct RX Port issues** Check the "RX port function" setting in VictronConnect. Does the set function match the application it is being used in. To test if the RX port is operational check its functionality using a [VE.Direct non-inverting remote on/off cable](#).

Note, unlike most other Victron products it is not possible to connect the Multi RS Solar to a GX device (i.e. Cerbo GX) using the VE.Direct interface. You must use the VE.Can interface to connect to a GX device.

### 6.9.4. VE.Smart communication

The Multi RS Solar does not support VE.Smart networking.

## 6.10. Error code overview

The error codes are displayed on the VictronConnect app, display or connected GX device.

For the most up-to-date version of this list see this link: <https://www.victronenergy.com/live/mppt-error-codes>.



Note that not all of these errors might apply to your product. Some error types only apply to solar chargers, DC-DC chargers or AC chargers or are specific only to certain models within a charger group.

### Error 2 - Battery voltage too high

- This error will auto-reset after the battery voltage has dropped. This error can be due to other charging equipment connected to the battery or a fault in the charge controller.

### Error 3, Error 4 - Remote temperature sensor failure

- Check if the T-sense connector is properly connected to a remote temperature sensor. Most likely cause: the remote T-sense connector is connected to the BAT+ or BAT- terminal. This error will auto-reset after proper connection.

### Error 5 - Remote temperature sensor failure (connection lost)

- Check if the T-sense connector is properly connected to a remote temperature sensor. This error will not auto-reset.

### Error 6, Error 7 - Remote battery voltage sense failure

- Check if the V-sense connector is properly connected to the battery terminals. Most likely cause: the remote V-sense connector is connected in reverse polarity to the BAT+ or BAT- terminals.

### Error 8 - Remote battery voltage sense failure (connection lost)

- Check if the V-sense connector is properly connected to the battery terminals.

### Error 11 - Battery high ripple voltage

- High DC ripple is usually caused by loose DC cable connections and/or too thin DC wiring. After the inverter has switched off due to high DC ripple voltage, it waits 30 seconds and then restarts.

After three restarts followed by a shutdown due to high DC ripple within 30 seconds of restarting, the inverter will shutdown and stops retrying. To restart the inverter, switch it Off and then On.

Continuous high DC ripple reduces the inverter life expectancy

### Error 14 - Battery low temperature

- The charger is stopped to avoid charging LiFePO4 batteries at low temperature as this damages the cells.

### Error 17 - Controller overheated despite reduced output current

- This error will auto-reset after charger has cooled down. Check the ambient temperature and check for obstructions near the heat sink.

### Error 18 - Controller over-current

- This error will auto-reset. If the error does not auto-reset disconnect the charge controller from all power-sources, wait 3 minutes, and power up again.

Possible causes for an over-current on the battery terminals:

- switching on/off a very large load on the battery side.
- sudden change in irradiance causing a temporary over-power in the mppt.
- overloading the inverter ac output.

Possible solutions:

- if possible provide adequate cooling for the unit, a cooler unit can handle more current.
- reduce the load on the inverter.
- charge the battery before using the inverter, at higher battery voltages the same amount of power requires less current.

### Error 20 - Maximum Bulk-time exceeded

- For solar chargers:

The maximum bulk time protection is a feature that was in the chargers when they were just released (2015 or earlier) and later the feature was removed.

If you do see this error, then update to the latest firmware.

If you then still have the error, perform a reset to factory defaults of the configuration, and reconfigure the solar charger.

**Error 21 - Current sensor issue**

- The current measurement is out of range.

Disconnect all wires, and then reconnect all wires, to make the charger restart. Also, make sure the minus on the MPPT charge controller (PV minus/Battery minus) is not bypassing the charge controller.

This error will not auto-reset.

If the error remains, please contact your dealer, there might be a hardware defect.

**Error 22 - Internal temperature sensor failure**

- The internal temperature measurements are out of range.

Disconnect all wires, and then reconnect all wires, to restart the unit.

This error will not auto-reset.

If the error remains, please contact your dealer, there might be a hardware defect.

**Error 26 - Terminal overheated**

- Power terminals overheated, check wiring, including the wiring type and type of strands, and/or fasten bolts if possible.

This error will auto-reset.

**Error 27 - Charger short circuit**

- This condition indicates an over-current condition on the battery side. It can occur when a battery is attached to the unit using a contactor. Or in case the charger starts up without a battery connected but connected to an inverter that has a large input capacitance.

This error will auto-reset. If the error does not auto-reset disconnect the charge controller from all power-sources, wait 3 minutes, and power up again. If the error persists the charge controller is probably faulty.

**Error 28 - Power stage issue**

- This error will not auto-reset.

Disconnect all wires, and then reconnect all wires. If the error persists the charger is probably faulty.

Note that this error was introduced in v1.36. So when doing an update, it might look like the firmware update caused this issue; but it doesn't. The solar charger was then already not performing 100% before the update; updating to v1.36 or later merely made the issue more visible. The unit needs to be replaced.

**Error 29 - Over-Charge protection**

- This error will auto-reset once the battery voltage drops below the float voltage. To protect the battery from over-charging the battery is disconnected.

Possible causes:

- over-sized PV array configuration, if there are too many panels in series the battery voltage cannot be reduced any further. Consider wiring more PV panels in parallel to reduce the voltage.
- configuration issue, check if the battery settings match with the installation (especially absorption and float voltage settings).
- another charger in the system raises the battery voltage above the expected level.

**Error 33 - PV over-voltage**

- This error will auto-reset after PV-voltage has dropped to safe limit.

This error is an indication that the PV-array configuration with regard to open-circuit voltage is critical for this charger. Check configuration, and if required, re-organise panels.

**Error 34 - PV over-current**

- The current from the solar-panel array has exceeded the maximum allowed current.

This error could be generated due to an internal system fault.

Disconnect the charger from all power-sources, wait 3 minutes, and power-up again. If the error persists the controller is probably faulty, contact your dealer.

**Error 35 - PV over-power**

- Applies to the MPPT RS, Inverter RS and Multi RS products.

Please upgrade your firmware to at least v1.08 as the issues causing this error have been addressed.

If you are using firmware v1.08 or newer this error indicates that the internal dc voltage is too high. This error will auto-reset.

If the error does not auto-reset disconnect the charge controller from all power-sources, wait 3 minutes, and power up again. If the error persists the charge controller is probably faulty.



**Error 38, Error 39 and Error 80 to Error 78 - PV Input shutdown**

- When these errors show, the PV Input is internally shorted in order to protect the battery from over-charging. Prior to any other trouble shooting, make sure to update to the latest firmware version.

Possible reasons for this error to occur:

- The Battery voltage (12/24/36/48V) is set incorrectly. Use VictronConnect to set the right Battery Voltage.
- There is another device connected to the battery, which is configured to a higher voltage. For example a MultiPlus, configured to equalise at 17 Volts, while in the MPPT this is not configured.

Error recovery:

- Error 38 and Errors 84 to 87: First disconnect the solar panels and disconnect the battery. Wait for 3 minutes, then reconnect the battery first and next the panels.
- Error 39: The charger will automatically resume operation once the battery voltage drops below its maximum voltage setting (normally Equalisation or Absorption voltages). It can also takes a minute to reset the fault.
- Errors 80 to 83: First disconnect the solar panels and disconnect the battery, then follow the reset procedure described [here](#).

If the error persists the charge controller is probably faulty.

**Error 40 - PV Input failed to shutdown**

- If the charger is unable to turn off the PV input, it will go into a safe mode in order to protect the battery from over-charging or having a high voltage on the battery terminals. In order to do that, the charger will stop charging and disconnect its own output. The charger will become faulty.

**Error 41 - Inverter shutdown (PV isolation)**

- PV panel isolation resistance too low. Check the PV array cabling and panel isolation, the inverter restarts automatically once the issue is resolved.

**Error 42 - Inverter shutdown (PV isolation)**

- The ground leakage current in the PV array exceeds the allowed 30mA limit. Check the PV array cabling and panel isolation. Check the installation and restart the unit using the power-switch.

**Error 43 - Inverter shutdown (Ground Fault)**

- The voltage difference between Neutral and Ground is too high.  
Inverter or Multi (not connected to the grid):
  - The internal ground relay is activated but the voltage over the relay is too high. The relay might be damaged.
 Multi (connected to the grid):
  - The ground wire in the installation is not present or not connected properly.
  - Line and Neutral are swapped in the installation.

This error will not auto-reset. Check the installation and restart the unit using the power-switch.

**Error 50, Error 52 - Inverter overload, Inverter peak current**

- Some loads like motors or pumps draw large inrush currents in a start-up situation. In such circumstances, it is possible that the start-up current exceeds the over current trip level of the inverter. In this case the output voltage will quickly decrease to limit the output current of the inverter. If the over current trip level is continuously exceeded, the inverter will shut down: wait 30 seconds and then restart.

The Inverter can supply more power than the nominal power level for a short time. If the time is exceeded the inverter stops.

After three restarts followed by another overload within 30 seconds of restarting, the inverter will shutdown and remain off. To restart the inverter, switch it Off, then On.

If the error persists reduce the load on the AC out terminal by switching off or disconnecting appliances.

**Error 51 - Inverter temperature too high**

- A high ambient temperature or enduring high load may result in shut down to over temperature. Reduce load and/or move inverter to better ventilated area and check for obstructions near the fan outlets.

The inverter will restart after 30 seconds. The inverter will not stay off after multiple retries.

**Error 53 - Inverter output voltage**

- If the battery voltage is getting low and a large load is applied to the AC output the inverter is unable to maintain the proper output voltage. Re-charge the battery or reduce the AC loads to continue operation.

**Error 54 - Inverter output voltage**

- If the battery voltage is getting low and a large load is applied to the AC output the inverter is unable to maintain the proper output voltage. Re-charge the battery or reduce the AC loads to continue operation.

If the error immediately pops up when switching on the inverter (without load) on a full battery the cause is most likely a broken internal fuse.

**Error 55, Error 56, Error 58 - Inverter self test failed**

- The inverter performs diagnostic tests before it activates its output. In the case that one of these tests fails an error message is displayed and the inverter does not turn on.

First try to restart the inverter, by switching it Off, and then On. If error persists the inverter is probably faulty.

**Error 57 - Inverter ac voltage on output**

- There is already AC voltage on the AC out terminal before switching on the inverter. Check that the AC out is not connected to a mains outlet or to another inverter.

This error will not auto-reset. Check the installation and restart the unit using the power-switch.

**Information 65 - Communication warning**

- Communication with one of the paralleled chargers was lost. To clear the warning, switch the charger off and back on.

**Information 66 - Incompatible device**

- The controller is being paralleled to another controller that has different settings and/or a different charge algorithm.

Make sure all settings are the same and update firmware on all chargers to the latest version.

**Error 67 - BMS Connection lost**

- This error shows when the charger is configured to be controlled by a BMS, but does not receive any BMS control messages. In that situation, the charger stops charging by reducing its output voltage to the battery base voltage (12V/24V/36V/48V). This is a safety mechanism, the reason to still enable the output is to allow a system to self-recover from a battery low situation.

Solar Chargers only show this error when there is solar power available and thus the device is ready to initiate charging. It does not show at night. And in case there is a permanent problem, the error will raise in the morning and clear at night, and so forth.

Solution: check the connection between the charger and the BMS.

How to reconfigure the charger to standalone mode:

Our Chargers and Solar Chargers automatically configure themselves to be BMS-controlled when they are connected to one; either direct or via a GX Device. And that setting is semi-permanent: power cycling the charger will not reset it.

When removing charger from such system, and reusing it in a system without BMS, that setting needs to be cleared. Here is how to do that:

- Chargers with LCD display: go into the setup menu, and change setting 'BMS' from 'Y' to 'N' (setup item 31).
- Other chargers: reset the charger to factory defaults with VictronConnect, and then reconfigure it.

**Error 68 - Network misconfigured**

- Applies to SmartSolar/BlueSolar chargers VE.Can (FW version v1.04 or higher) and SmartSolar VE.Direct chargers (FW version v1.47).

To clear the error on the SmartSolar VE.Direct chargers update the FW version to v1.48 or higher.

To clear the error on the SmartSolar/BlueSolar chargers VE.Can, update the software. If the error persists, it will be because the charger is connected with both a VE.Direct cable and on VE.Can. That is not supported. Remove one of the two cables. The error will disappear and the charger will resume normal operation, within a minute.

Background:

Error 68 indicates that the charger detects multiple conflicting network sources, with the same priority, trying to send the same information to the charger. VE.Can and VE.Direct interfaces have both the same priority level, and BLE (using VE.Smart Networking) has a lower priority.

Having a higher priority level means that, if the same information (e.g. Battery voltage sense) is being received from both VE.Can and BLE (using VE.Smart Network) by the charger, the information on VE.Can will be used and the one coming from BLE will be ignored.

Now, if the same information is being received from two interfaces that have the same priority level (as VE.Can and VE.Direct), the charger does not know how to prioritize those, causing error 68 to be triggered.

**Error 69 - Network misconfigured**

- Applies to Inverter RS and Multi RS models. Firmware versions 1.11 and higher.

This error indicates an issue in the configuration. There are units present on the same can bus that have different system configurations. Please ensure that all units are set to either "Single Phase" or "Three Phase". All units will remain off until the configuration is fixed, after which the units will resume operation.

**Error 70 - Network misconfigured**

- Applies to Inverter RS models. Firmware versions 1.11 and higher.

The Inverter RS model used cannot be paired with a Multi RS and/or Transfer Switch. Only Inverter RS models with a production code newer than HQYYWW can be used for this purpose. Only the incompatible Inverter RS units will remain off.

**Error 71 - Network misconfigured**

- Applies to Inverter RS and Multi RS models. Firmware versions 1.11 and higher

There are units present with incompatible firmware on the can bus. Make sure that all units are updated to the same firmware version. All units will remain off until the until the firmwares are updated, after which the units will resume operation.

**Error 114 - CPU temperature too high**

- This error will reset after the CPU has cooled down. If the error persists, check the ambient temperature and check for obstructions near the air inlet and outlet holes of the charger cabinet. Check manual for mounting instructions with regard to cooling. If error persists the controller is probably faulty.

**Error 116 - Calibration data lost**

- If the unit does not work and error 116 pops up as the active error, the unit is faulty. Contact your dealer for a replacement.

If the error is only present in the history data and the unit operates normally this error can be ignored safely. Explanation: when the units power up for the very first time in the factory, it does not have calibration data and an error 116 is logged. Obviously this should have been cleared, but in the beginning units left the factory with this message still in the history data.

SmartSolar models (not the BlueSolar models): upgrading to v1.4x firmware is a one-way trip, you cannot go back to an older firmware version once you upgrade to v1.4x. Reverting to older firmware gives error 116 (calibration data lost), this can be fixed by re-installing the v1.4x firmware.

**Error 117 - Incompatible firmware**

- This error indicates that a firmware update did not complete, so the device is only partially updated. Possible causes are: device out of range when updating over the air, a cable got disconnected or power was lost during the update session.

To fix this the update needs to be retried, download the correct firmware for your device from the [Victron Professional Portal](#)

When your GX device is connected to VRM, you can do a remote firmware update using this firmware file. You can do this via the VRM website or using the VRM tab in VictronConnect. VictronConnect can also be used together with the firmware file to update using a Bluetooth connection.

The procedure to add the file to VictronConnect and start the update is described here: [9. Firmware updates](#)

**Error 119 - Settings data lost**

- The charger cannot read its configuration, and stopped.

This error will not auto-reset. To get it working again:

1. First, restore it to factory defaults. (top right in Victron Connect, click on the three dots)
2. Disconnect the charge controller from all power-sources
3. Wait 3 minutes, and power up again.
4. Reconfigure the charger.

Please do report this to your Victron dealer and ask him to escalate it to Victron; as this error should never happen. Preferably include firmware version and any other specifics (VRM URL, VictronConnect screenshots or similar).

**Error 121 - Tester fail**

- If the unit does not work and error 121 pops up as the active error the unit is faulty, contact your dealer for a replacement.

If the error is only present in the history data and the unit operates normally this error can be ignored safely. Explanation: when the units powers up for the very first time in the factory, it does not have calibration data and an error 121 is logged. Obviously this should have been cleared, but in the beginning units left the factory with this message still in the history data.

**Error 200 - Internal DC voltage error**

- The unit performs internal diagnostics when activating its internal DC-DC converter. This error indicates that something is wrong with the DC-DC converter.

This error will not auto-reset. Check the installation and restart the unit using the power-switch. If the error persists the unit is probably faulty.

**Error 201 - Internal DC voltage error**

- Applies to the MPPT RS, Inverter RS and Multi RS.

This "Internal DC voltage measurement error", is raised in case an internal (high-) voltage measurement does not match certain criteria.

First, make sure to update the firmware to v1.08 or later. The limits were too strict in earlier versions. And it could trigger falsely during MPPT start-up in the morning and MPPT shutdown in the evening.

If the error still occurs after updating to v1.08 or later, then it means that a measurement circuit inside the unit is broken.

This error will not auto-reset. Check the installation and restart the unit using the power-switch. If the error persists, even after above mentioned firmware update, the unit is most likely faulty and must be sent in for repair/replacement.

**Error 202 - Internal GFCI sensor error**

- The sensor used to measure residual current did not pass the internal self test.

This error will not auto-reset. Check the installation and restart the unit using the power-switch. If the error persists the unit is probably faulty and must be sent in for repair/replacement.

**Error 203, Err 205, Err 212, Err 215 - Internal supply voltage error**

- The unit performs internal diagnostics when activating its internal voltage supplies. This error indicates that something is wrong with an internal supply voltage.

This error will not auto-reset. Check the installation and restart the unit using the power-switch. If the error persists the unit is probably faulty.

## 7. Technical Specifications

Multi RS Solar 48/6000/100-450/100 - PMR482602020	
PowerControl & PowerAssist	Yes
Transfer Switch	50 A
Maximum AC input and pass-through current	50 A
<b>INVERTER</b>	
DC Input voltage range (1)	38 – 62V
AC Output (2)	Output voltage: 230 Vac $\pm$ 2% Frequency: 50 Hz $\pm$ 0,1% (1) Maximum continuous inverter current : 25 Aac
Continuous output power at 25°C	Increases linearly from 4800 W at 46 VDC to 5300 W at 52 VDC
Continuous output power at 40°C	4500W
Continuous output power at 65°C	3000W
Peak power (3)	9 kW for 3 seconds 7 kW for 4 minutes
Short-circuit output current	45 A
Max. AC output overcurrent protection	30 A
Maximum efficiency	96.5% at 1 kW load 94% at 5 kW load
Zero load power	20W
Low battery shutdown	37.2 V (adjustable)
Low battery restart	43.6 V (adjustable)
<b>SOLAR</b>	
Maximum DC voltage (4)	450 V
Start-up voltage	120 V
MPPT voltage range	80 – 450 V
Maximum operational PV input current limit	13 A
Max. PV short circuit current	16 A
Maximum DC solar charging power	6000 W total - 3000 W per tracker
Earth leakage trip level	30 mA
Isolation fail level (detection before start-up)	100 k $\Omega$
<b>CHARGER</b>	
AC Input	Input voltage range: 187-265 VAC Input frequency: 45-65 Hz Nominal Voltage 230 Vac Nominal frequency: 50 Hz AC inrush current: NA
Programmable charger voltage range (5)	36 - 60 V
Charge voltage 'absorption'	default: 57.6 V (adjustable)

Multi RS Solar 48/6000/100-450/100 - PMR482602020	
Charge voltage 'float'	default: 55.2 V (adjustable)
Maximum charge current from AC (6)	88 A @ 57.6V
Total maximum combined charger current (AC + PV)	100 A
Battery temperature sensor	Included
Battery voltage sense	Yes
<b>GENERAL</b>	
Parallel and 3-phase operation	3 Phase supports 1 unit per phase. Parallel not supported.
Auxiliary output (AC-out-2) (7)	Yes
Programmable relay (8)	Yes
Protection (9)	a - g
Data Communications (10)	VE.Direct port, VE.Can port & Bluetooth
Bluetooth frequency	2402 - 2480 Mhz
Bluetooth power	4 dBm
General purpose analog/digital in port	Yes, 2x
Remote on-off	Yes
Operating temperature range	-40 to +65°C (fan assisted cooling)
Maximum altitude	2000 m
Humidity (non-condensing)	max 95%
<b>ENCLOSURE</b>	
Material & Color	steel, blue RAL 5012
Protection category	IP21 Protective Class: I
Battery-connection	M8 bolts
PV Connection	2 strings, each with positive and negative MC4
230 V AC-connection	Screw terminals 10 mm <sup>2</sup> (6 AWG)
Weight	12.3 kg
Dimensions (hxwxh)	425 x 460 x 125 mm
<b>STANDARDS</b>	
Safety	EN-IEC 60335-1, EN-IEC 60335-2-29, EN-IEC 62109-1, EN-IEC 62109-2
Emission, Immunity	EN 55014-1, EN 55014-2 EN-IEC 61000-3-2, EN-IEC 61000-3-3 IEC 61000-6-1, IEC 61000-6-2, IEC 61000-6-3 Pollution Degree 2
Overvoltage Category	Battery: OVC I PV port: OVC II AC in / AC out: OVC III

## Multi RS Solar 48/6000/100-450/100 - PMR482602020

- 1) Minimum start-up voltage is 41 VDC. Over-voltage disconnect: 65,5 V.
- 2) Can be adjusted to 240VAC and 60 Hz
- 3) Peak power capacity and duration depends on start temperature of heatsink. Mentioned times are with cold unit.
- 4) The maximum PV voltage should not exceed 8x battery float voltage. If for example the float voltage of the battery is 50 V, the maximum PV voltage should not exceed  $8 \times 50 = 400$  V.
- 5) The Charger set points (float & absorption) can be set to max 60 V. The output voltage at the charger terminals can be higher due to compensation for temperature & voltage drop over the battery cables. The maximum output current is reduced on a linear basis from full current at 60 V to 5A at 62 V. The equalization voltage can be set to max 62V, the equalization current percentage can be set to max 6%.
- 6) The maximum charge current from AC sources depends on input voltage and battery current. At 230V input and 57.6V battery voltage, and 25C ambient, the maximum charge current is 88A. See manual, limitations section, for further details.
- 7) AC-out-2 is connected directly to the AC input and intended for non-critical loads. The AC-out-2 load is taken into account by PowerControl & PowerAssist.
- 8) Programmable relay which can be set for general alarm, DC under voltage or genset start/stop function. DC rating: 4 A up to 35 VDC and 1 A up to 70 VDC
- 9) Protection key: a) output short circuit b) overload c) battery voltage too high d) battery voltage too low e) temperature too high f) 230 VAC on inverter output g) solar earth leakage.
- 10) Not currently compatible with VE.Smart Networks. Connection to a GX device (i.e. Cerbo GX) must be made via the VE.Can interface. The VE.Direct interface is for connection to the GlobalLink 520.

## 8. Appendix

### 8.1. Appendix A : Connection Overview

Figure 2. Multi RS Solar Front

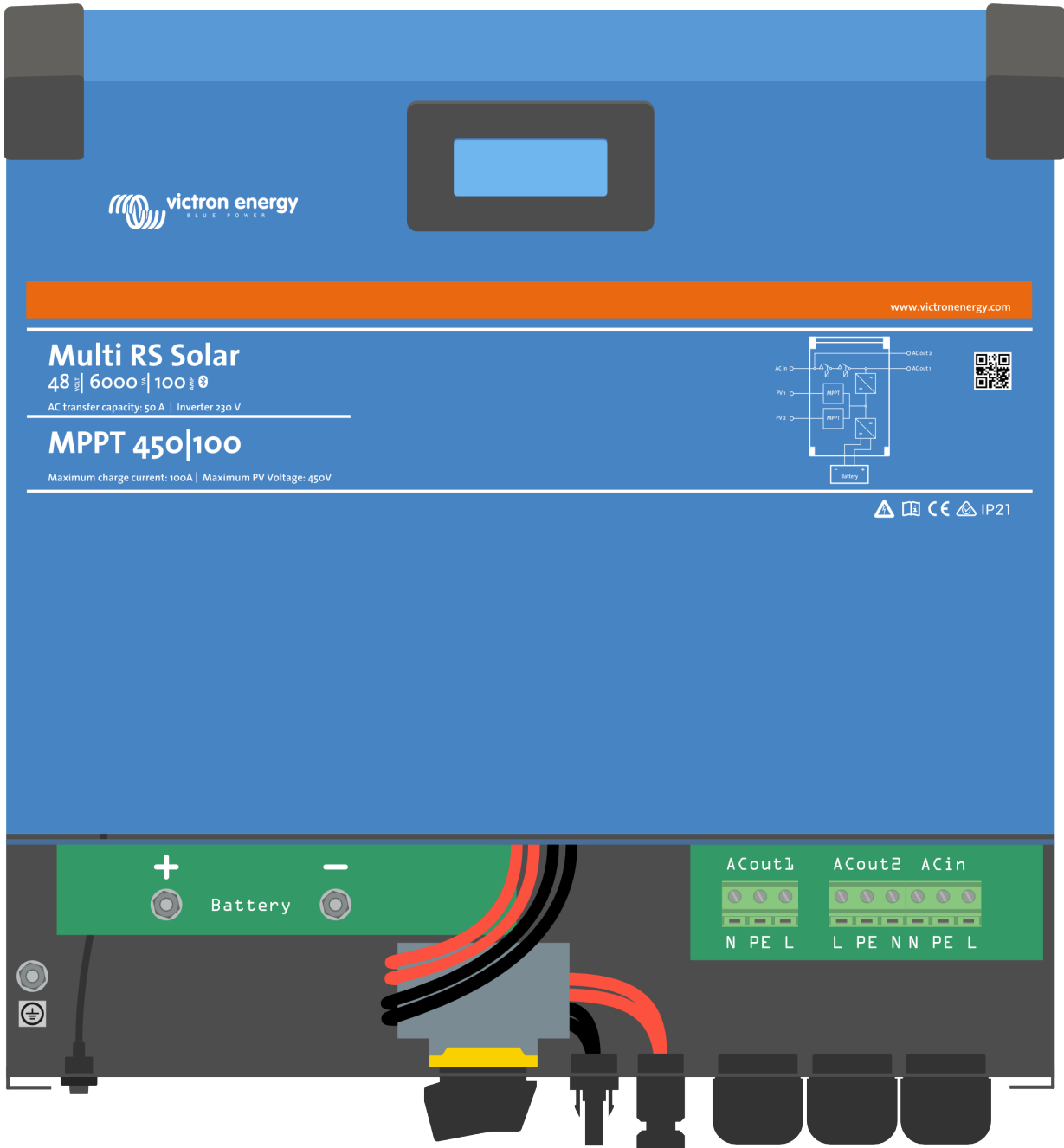



Figure 3. Multi RS Solar Bottom

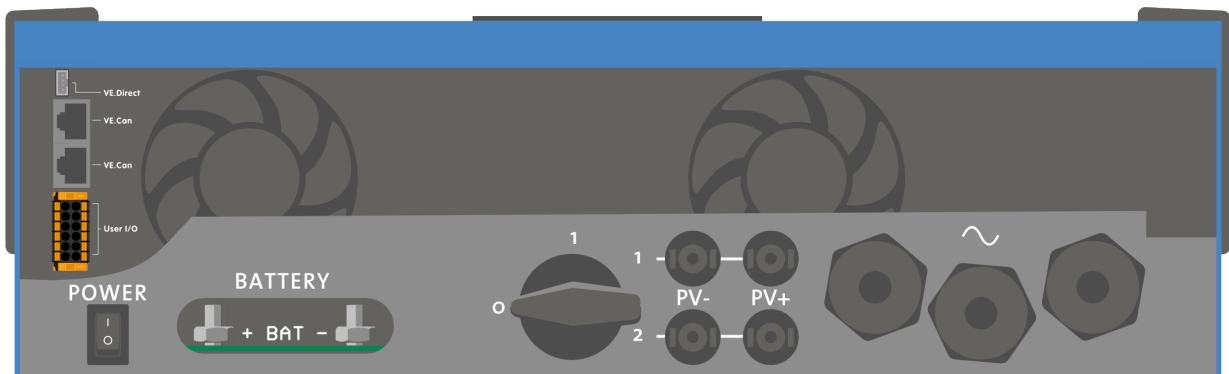
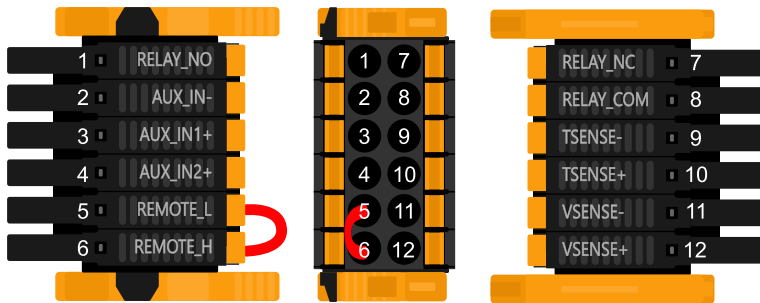

Figure 4. User I/O



User I/O Connector is located on bottom left side of connection area, diagram shows 3 perspectives. Left Side - Top - Right Side

Table 4. User I/O Functions - See Installation Section for more details.

Number	Connection	Description
1	Relay_NO	Programmable relay Normally Open connection
2	AUX_IN -	Common negative for programmable auxiliary inputs
3	AUX_IN1+	Programmable auxiliary input 1 positive connection
4	AUX_IN2+	Programmable auxiliary input 2 positive connection
5	REMOTE_L	Remote on/off connector Low
6	REMOTE_H	Remote on/off connector High
7	RELAY_NC	Programmable relay Normally Closed connection
8	RELAY_COM	Programmable relay common negative
9	TSENSE -	Temperature Sensor negative
10	TSENSE +	Temperature Sensor positive
11	VSENSE -	Voltage Sensor negative
12	VSENSE +	Voltage Sensor positive

## 8.2. Appendix B : Block Diagram

Figure 5. Multi RS Solar

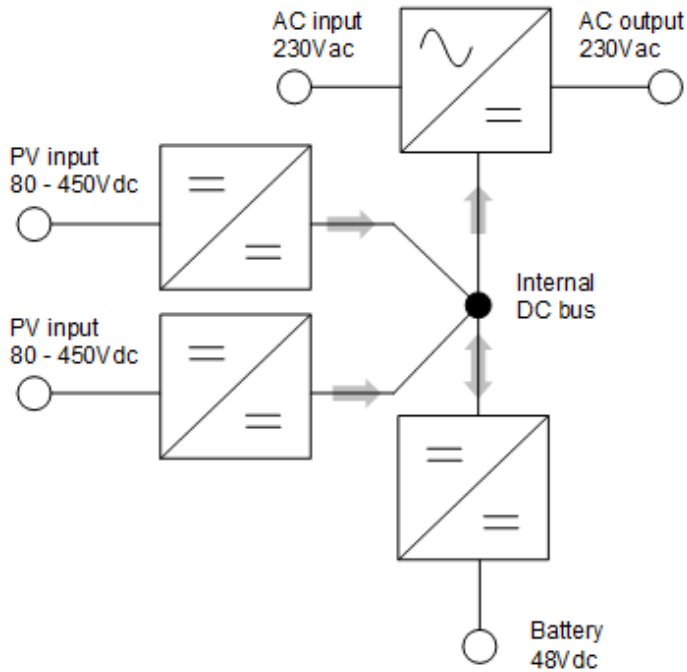

## 8.3. Appendix C : Example Wiring Diagram

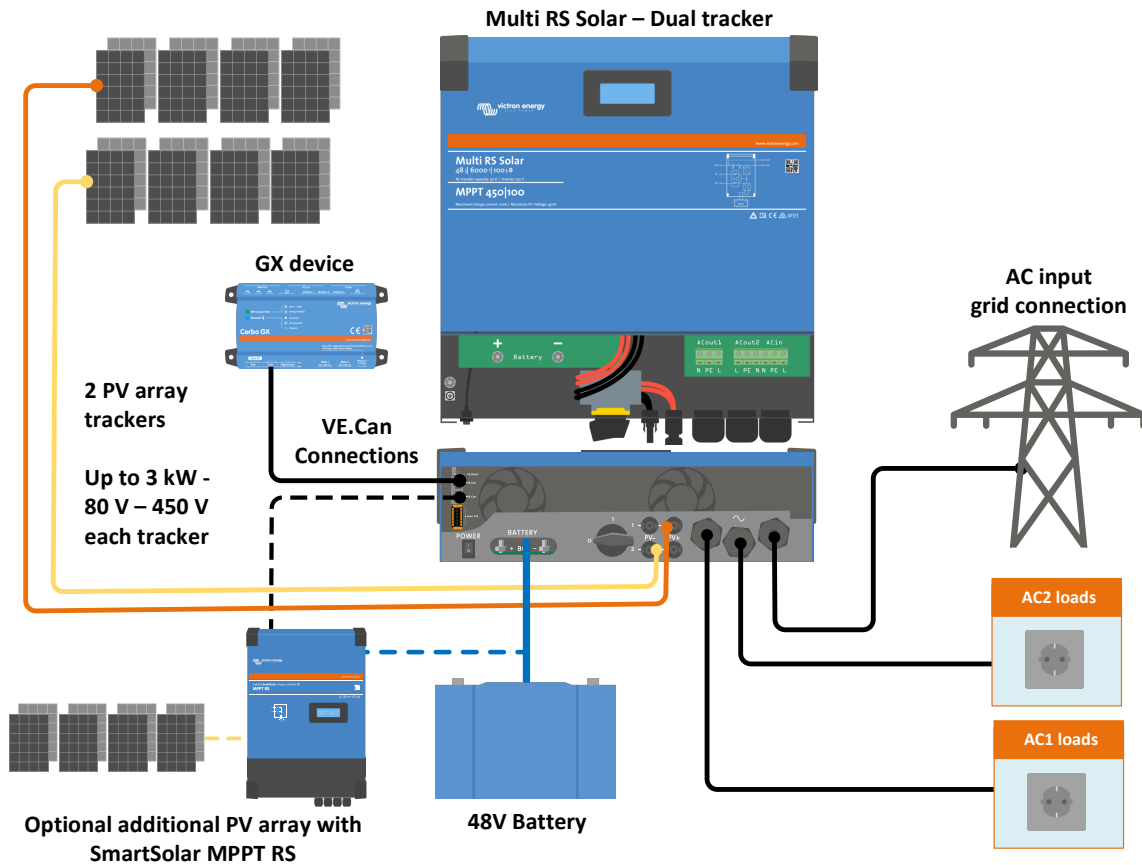
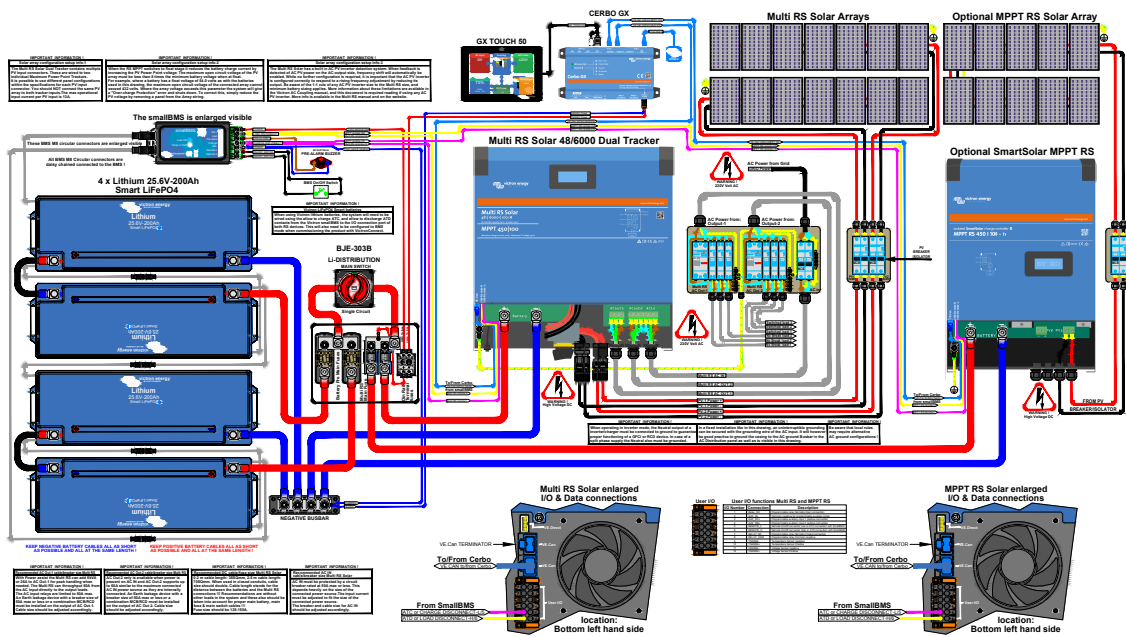

Figure 6. Multi RS Solar full wiring diagram



See here for highest resolution and most up-to-date schematics - <https://www.victronenergy.com/inverters-chargers/multi-rs-solar#system-schematic>

### 8.4. Appendix D : Dimensions

Figure 7. Multi RS Solar

