



DH200F

USER MANUAL

EnerCore
Smart Outdoor Integrated
Energy Storage Cabinet

Contents

Statement of Law	1
Revised History	1
1 Guidelines for The Operation of The Manual	2
Use of manuals	2
Applicable products	2
Product Profile	2
Symbol mark	3
Abbreviations	3
2 Security Instructions	5
General principles of security	5
Operator qualifications	5
Safety requirements for the environment	6
Safety requirements for installation	6
Safety requirements for use	7
Daily operation and maintenance	8
Product obsolescence	8
3 Product Description	9
Product System Overview	9
Product Composition	10
Appearance design	11
Internal design	13
System parameters	16
Core Modules	17
Application Scenario	21
4 Delivery, Transportation and Storage	24
Unpacking and Inspection	24
Shipping Requirements	24
Storage Requirements	26
5 Installation	28
Pre-installation inspection	28
Installation environment requirements	28
Installation space requirements:	29
Wiring	32
6 System Running and Stop	40
Product power-on process	40
Product power off process	41
7 Human-Machine Interface of HMI Screen (optional)	42
Introduction to Operating System	42
Login Operation Guide	43
Fault description	46
8 System Maintenance	47
9 Quality Assurance	48

10 Appendix.....49

Statement of Law

The copyright of this document belongs to Dy Ness Digital Energy Technology Co., LTD.

(the following will be referred to as "Dy Ness")

No part of this document may be excerpted, translated, annotated or reproduced in any form or by any means without the prior written authorization of Dy Ness.

It is prohibited to use part or all of the data in the firmware or software developed by the Company for commercial purposes in any way.

It is prohibited to decompile, decrypt or otherwise damage the original program design of the software developed by the Company.

This product complies with the design requirements for environmental protection and personal safety. The storage, use and disposal of the product shall be in accordance with the product manual, relevant contract or relevant laws and regulations.

When products or technologies are updated, customers can check the information on the website of Dy Ness.

Website: <http://www.dyness.com/>

Please note that products can be modified without prior notice.

Revised History

Revised version	Revision Date	Revision Reason
1.0	2023.6.10	First publication
2.0	2023.7.10	

1 Guidelines for the operation of the manual

CAUTION: Read this manual carefully before installing or operating this product. Keep this manual in a safe place for future reference.

Use of manuals

- Manual content: This manual mainly introduces the safety precautions, product functions and specification parameters, delivery and storage, wiring installation, product power up and down process, human-machine interface operation, system maintenance and quality assurance of the Smart Energy Storage Outdoor Integrated Cabinet.
- Applicable population: This manual is suitable for professional technicians who install and maintain the smart energy storage outdoor integrated cabinet, as well as users who carry out daily operation. Readers need to have certain electrical knowledge and electrical principles.

Applicable products

This manual applies to various models of EnerCore products, including DH200F-S150L00, DH200F-S100L00, DH200F-S050L00, DH200F-S000L00, DH200F-S150L01, DH200F-S100L01, DH200F-S050L01, DH200F-S000L01 models. S050L01, DH200F-S000L01 models. Product names and system models are explained below:

- EnerCore: Product name
- DH: Dy Ness high-voltage series products.
- 200: battery capacity (specific equipment capacity is subject to the actual object)
- F: air cooling system
- S: photovoltaic, the number after S indicates the photovoltaic power, 000 indicates that there is no photovoltaic in the initial setup, but the product is reserved for photovoltaic access equipment, which can be expanded to access photovoltaic in the future;
- L: on-grid and off-grid, the number 00 after L indicates pure on-grid (on-grid rated power is 100KW), and the number 01 after L indicates on-grid and off-grid (both on-grid and off-grid rated power is 100KW).

Product Profile

- Function introduction: This product is an outdoor integrated cabinet that incorporates an energy storage system, providing users with functions such as peak shaving and load shifting, capacity reduction and demand reduction, new energy upgrading and consumption, demand response and backup power and other functional services. It can be widely used in charging stations, commercial buildings, manufacturing industry and other industrial and commercial scenarios.
- Optional models: The outdoor integrated cabinet of this product integrates battery module, BMS, PCS, MPPT (optional), STS (optional), power distribution system, fire protection system, air conditioning system, etc.. Various models can be configured depend on the combination of different modules.





Table 1-1 Product Profile

No.	Model	Description
1	DH200F-S150L00	PV+ESS, PV: 150KW, On-grid: 100KW, no off-grid
2	DH200F-S100L00	PV+ESS, PV: 100KW, On-grid: 100KW, no off-grid
3	DH200F-S050L00	PV+ESS, PV: 50KW, On-grid: 100KW, no off-grid
4	DH200F-S000L00	PV+ESS, no PV, On-grid: 100KW, no off-grid
5	DH200F-S150L01	PV+ESS, PV: 150KW, On-grid: 100KW, off-grid: 100KW
6	DH200F-S100L01	PV+ESS, PV: 100KW, On-grid: 100KW, off-grid: 100KW
7	DH200F-S050L01	PV+ESS, PV: 50KW, On-grid: 100KW, off-grid: 100KW
8	DH200F-S000L01	PV+ESS, no PV, On-grid: 100KW, off-grid: 100KW

Symbol mark

This manual may contain the following symbols to emphasize important information, to ensure the safety of the user's personal and property when installing this product, or to facilitate the efficient use of this manual by the user, please read it carefully.

Table 1-2 Symbol mark

	Indicates that there is high voltage inside the body, so beware of electrocution resulting in personal safety issues.
	Indicates an electrical hazard, all external power connections must be disconnected prior to performing operational maintenance on the equipment.
	Anti-temperature marking
	Ventilation marking
	Indicate that there is the protective earthing (PE) terminal, which is used to prevent electric shock in the event of a fault, and needs to be firmly earthed to ensure operator safety.

Abbreviations

References to the following products in this brochure are replaced by abbreviations for ease of presentation

Table 1-3 Abbreviation definition

BESS	Battery Energy Storage System
BMS	Battery Management System
PCS	Power Conversion System
MPPT	Maximum Power Point Tracking
STS	Static Transfer Switch
SOC	State of Charge
PV	Photovoltaic
DC	Direct Current
AC	Alternating Current

2 Security instructions

General principles of security

This chapter introduces the safety matters that need to be taken care of in the energy storage outdoor cabinet, and the related safety precautions need to be strictly followed during installation, operation and maintenance. This product is a combined high-voltage DC and three-phase AC system and should only be operated by authorized personnel.



DANGER

- Deadly high voltages are present inside the product, please observe and comply with the warning labels on the product and do not touch the power grid or the contacts connected to it inside the device to prevent the risk of fatal electric shock!
- Always ensure that the product is free of any electrical connections before installing it.
- Insulated protective equipment in accordance with safety regulations must be worn during installation.
- Damage to the battery may result in electrolyte leakage. If the electrolyte leaks, do not touch the leaking electrolyte or volatile gases and contact the after-sales service team immediately for assistance.



WARNING

- Only specialized electricians or qualified personnel may operate and wire the product.
- Installation work must be assigned to a specialized full-time operator;



FORBID

- Risk of damage to the battery system or personal injury or behavior is prohibited.
- Replacement of the modules by the user is prohibited and the company will not be responsible for any damages caused.

Operator qualifications

A qualified operator refers to someone who has the necessary knowledge, specialized training and experience, for example:

- Only qualified personnel who are familiar with local standards and relevant safety codes for electrical systems should wire this product;
- The operator should have received professional training related to the installation and commissioning of electrical equipment, and should have the ability to respond to emergencies or unexpected situations that may occur during installation or trial operation;
- The operator shall have certain specialized knowledge of electronics, electrical wiring and machinery, and be familiar with electrical and mechanical schematic diagrams;
- The Operator should be fully familiar with equipment protection and standard

maintenance, and operations should comply with established safety standards;

Safety requirements for the environment

- Do not install and use the product in environments with temperature below -20°C or above 50°C;
- Do not install and use the product near any heat sources or combustible materials;
- Do not install and use the product in areas with frequent movement of personnel;
- Do not expose the product to corrosive gases or liquids;
- Keep the product installation and use away from children and animals;
- The maximum installation altitude for the product should not exceed 3000m, and it should be derated when above 2000m;
- Sufficient space should be reserved for the installation of the product to ensure adequate ventilation;
- Isolation barriers must be set up during installation to prevent any unrelated personnel from entering the site;

Safety requirements for installation

Before installation:



WARNING

Lifting and Transportation

- Forklifts, cranes and other construction machinery must be operated by qualified operators if required on site;

Installation check

- Before installation, be sure to check the product for any damage that may have occurred during transportation;

During installation:



WARNING

Personnel Code of Conduct

- When connecting the power on-site, a designated guardian must be assigned to protect the switches that need to be turned off;
- Each completed project must be checked at least once and cross-checked during the installation process;
- The equipment must be installed in sequence without skipping any steps.

Installation check

- Before installation, be sure to check the product for any damage that may have occurred during transportation;

Wiring Device Specifications

- Appropriate measuring devices must be used and appropriate standards and directives must be followed. The operating manual of the measuring device must be known before any measurement is carried out;
- Only use equipment specified by Dyness. Failure to use equipment specified by Dyness

may result in impaired protection as well as injury to personnel.



DANGER

Personnel Code of Conduct

- Do not change fuse size or rating during installation;
- It is not allowed for two or more operators to connect a single wire simultaneously during the wiring process.

Safety requirements for use

- The operator must ensure that: before commissioning and switching off the disconnecting circuit-breaker, all basic information and step-by-step instructions are known and, in particular, the safety instructions for assembly and installation must be strictly observed;
- The operator must be equipped with protective clothing and specialized tools in accordance with local laws and regulations;



WARNING

Test run after installation

- Only put into operation after confirmation by a professional and permission from the local power department;
- Turn off all distribution circuit breakers before operation, and strictly prohibit disconnection during machine operation.



DANGER

Battery protection safety

When installing, maintaining and overhauling the equipment, it is necessary to ensure that:

- The storage battery is completely disconnected.
- Have a visible warning sign at the point of disconnection to ensure that there are no accidental reconnections.

Ground Fault Protective Safety

- When a ground fault occurs in an integrated energy storage system, the original non-electrified part may carry high voltage, and accidental electric shock can lead to personal safety! Ensure that there is no ground fault and take the necessary protective measures before operation.

Safety of energized measurements

- High voltages are present in this equipment, so it is important to protect yourself (e.g., wear insulated gloves, etc.) when making measurements with electricity, and you must be accompanied by a person to ensure your personal safety.

Arc protection safety

- Avoid arc, fire and explosion hazards caused by improper operation:
 - Prohibit touching the ends of potentially energized cables that are not insulated;
- When a loose connection occurs in the power cable, or a screw or other component falls out accidentally, do not operate it without authorization, and it must be handled by a qualified professional to avoid causing a larger malfunction.

Daily operation and maintenance

- All operations of the energy storage system should follow the instructions in the User Manual. Damage to the equipment caused by violation of these instructions will void the associated liability and warranty.
- If necessary, contact Dyness Customer Service for repairs.



WARNING

Routine operation and maintenance requirements

- The software, housing and components of the device may not be changed without the manufacturer's authorization. If changed, the corresponding liability and warranty shall be void.
- Do not remove or alter the nameplate;
- Do not open the cabinet doors in inclement weather such as rain or strong winds;

Product obsolescence

When the product as a whole or individual internal components become aged or damaged and need to be discarded, they cannot be disposed of as regular waste. Some components inside the product can be recycled and reused. Improper disposal of certain components may cause environmental pollution.

Please contact qualified local professional recycling organization for proper disposal of the product and internal components.

3 Product Description

Product System Overview

This product can provide industrial and commercial users with a complete solution of outdoor integrated PV& energy storage system (the following will be referred to as "PV+ESS"). The product can realize the management, storage and utilization of electric energy through battery storage technology, which can help balance the energy fluctuation between supply and demand and improve the efficiency of energy utilization. Its main function is to distribute photovoltaic DC power or grid AC power to the storage battery and inverter output. This enables users to benefit from services such as peak shaving & load shifting, capacity & demand reduction, new energy upgrading and consumption, demand response and backup power, etc. It can be widely used in scenarios such as charging stations, factories, industrial parks, and commercial buildings. This product can realize integrated delivery, intelligent operation and maintenance management and all-round security assurance.

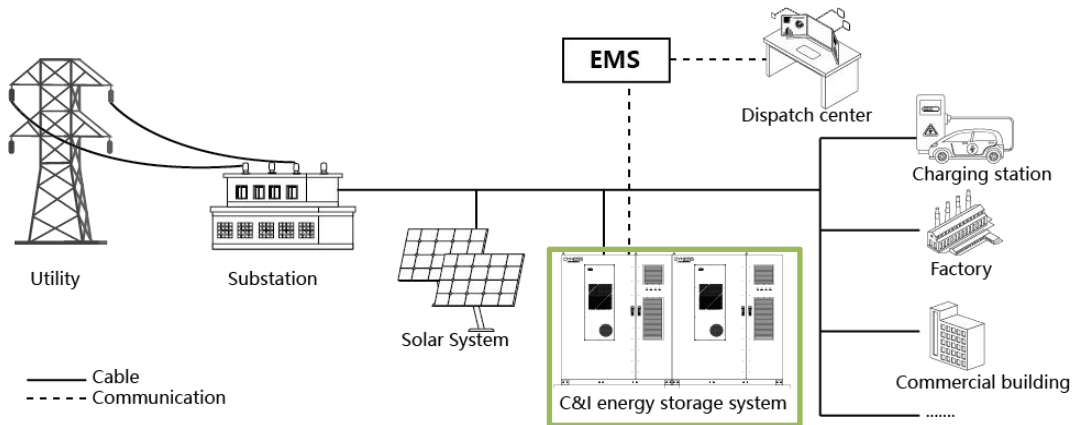

Figure 3-1 System working principle diagram

This product is a combination of high-voltage DC and three-phase AC system, the system are modularized design and the capacity can be flexibly configured. The systematic safety design ensures the efficient and long-life operation of the battery. The product can achieve an integrated on-grid and off-grid solution, supporting seamless switching between the two mode. The system has a storage capacity of 215 kWh.

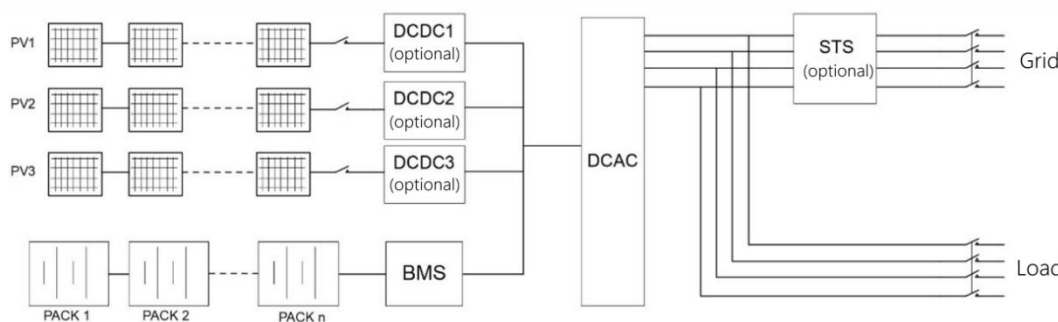

Figure 3-2 System schematic topology diagram

Product Composition

- System Composition: The energy storage system of this product mainly includes battery module, BMS, PCS, MPPT (optional), STS (optional), power distribution system, fire protection system, air-conditioning system and so on.

Table 3-1 Product composition

Module Name	functionality	Module Selection
battery module	For electrical energy storage	compulsory
BMS module	Collect battery information and control battery charging and discharging	compulsory
MPPT Module	Maximizing PV power	1-3 (optional)
PCS module	AC and DC bi-directional conversion	compulsory
STS module	Automatic fast switching between on-grid and off-grid	1 (optional)
EMS Module	Energy management and total control of the entire system	compulsory
power distribution system	Includes circuit breakers, wiring harnesses, fuses, etc.	compulsory
fire protection system	Timely warning of battery thermal runaway characteristics and making correct instructions	compulsory
air conditioning system	Regulates the battery operating temperature to ensure that the battery operates at the optimal temperature	compulsory

The system is designed with many functions, and users can select and configure accessories based on their actual needs to achieve different purposes. The table of optional accessories is as follows:

Table 3-2 Optional accessories list

Optional Accessories	Optional quantity	Functional Description
STS Module	1	200kW with automatic switching between on-grid and off-grid
MPPT Module	1-3	Transmits the energy generated by the PV panels to the system
HMI screen	1	User interface

Users can independently choose optional accessories for this product based on power requirements, whether to install PV systems, on-grid/off-grid demands and etc. By combining different modules, the different models can be configured as follows:

Table 3-3 module configuration

NO.	Model	Description	Optional accessories
1	DH200F-S150L00	PV+ESS, PV: 150KW, On-grid: 100KW, no off-grid	MPPT module: 3 STS module: None
2	DH200F-S100L00	PV+ESS, PV: 100KW, On-grid: 100KW, no off-grid	MPPT module: 2 STS module: None
3	DH200F-S050L00	PV+ESS, PV: 50KW, On-grid: 100KW, no off-grid	MPPT module: 1 STS module: None
4	DH200F-S000L00	PV+ESS, no PV, On-grid: 100KW, no off-grid	MPPT module: None STS module: None
5	DH200F-S150L01	PV+ESS, PV: 150KW, On-grid: 100KW, off-grid: 100KW	MPPT module: 3 STS module: 1
6	DH200F-S100L01	PV+ESS, PV: 100KW, On-grid: 100KW, off-grid: 100KW	MPPT module: 2 STS module: 1
7	DH200F-S050L01	PV+ESS, PV: 50KW, On-grid: 100KW, off-grid: 100KW	MPPT module: 1 STS module: 1
8	DH200F-S000L01	PV+ESS, no PV, On-grid: 100KW, off-grid: 100KW	MPPT module: None STS module: 1

Appearance design

The exterior view of BESS is as follows:

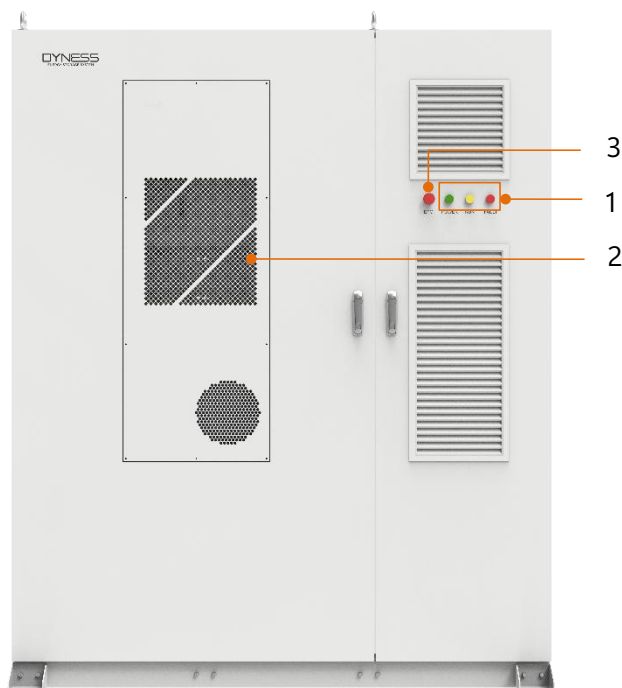

Figure 3-3 BESS exterior (front view)

Table 3-4 BESS Appearance definition

No.	Name	Functionality
1	Indicator light	Operation indicator, fault indicator, alarm indicator
2	Air conditioner	Regulates the temperature of the battery compartment in the cabinet
3	Emergency stop button	The system stops when the button is pressed

* CAUTION: Do not operate the emergency stop button in a non-emergency situation.

On the upper left side of the outdoor integrated cabinet, there are three indicator lights showing the main operating status of the product, namely the power indicator "POWER", the operation indicator "RUN" and the alarm indicator "FAULT".

Table 3-5 Indicator Definition

Item	Name	Functionality
●	Power indicator light	Constant light indicates power is applied and ready for operation.
●	Operation Indicator Light	Constant light indicates normal system operation, off indicates standby.
●	Alarm indicator	Constant light indicates a system malfunction

Component Size:

The BESS is approximately 1846mm long, 1203mm wide (not counting the retainer) and 2250mm high (not counting the lifting ring), the BESS dimensions are as follows:

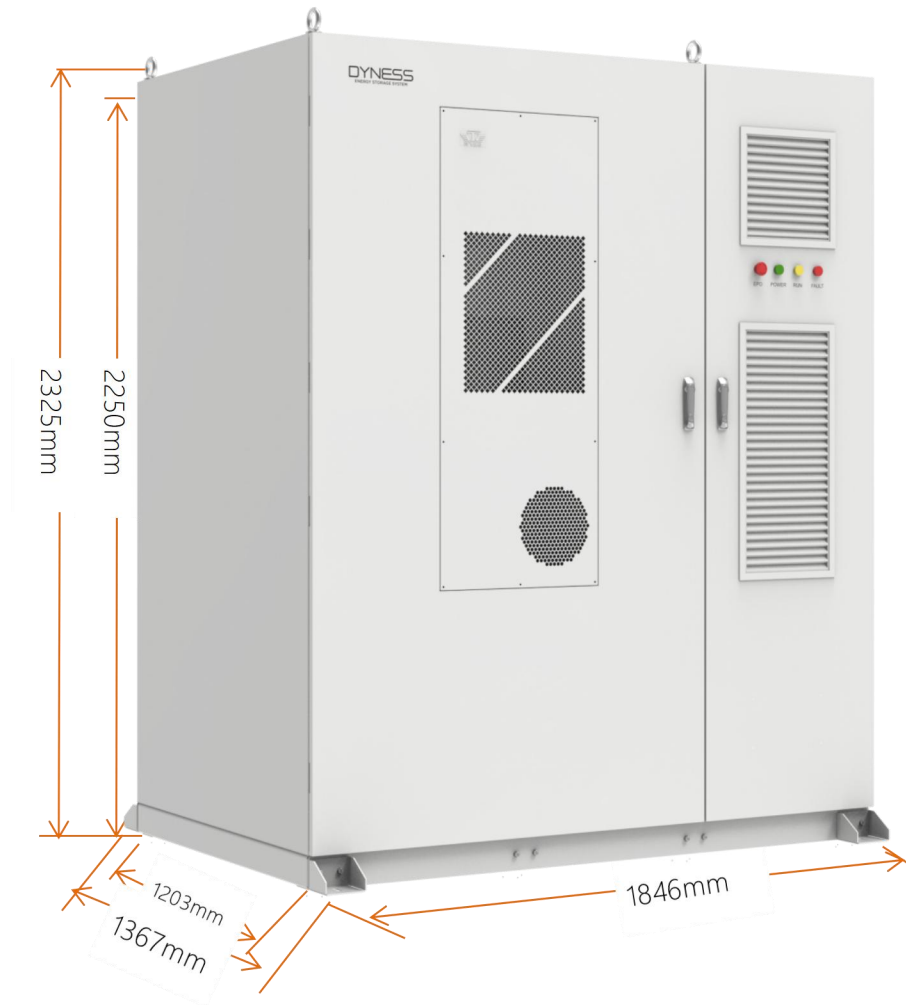

Figure 3-4 BESS Dimensional drawing

*The above pictures are for reference only, please refer to the actual object received.

Internal design

The internal structure and composition of the BESS is shown as below:

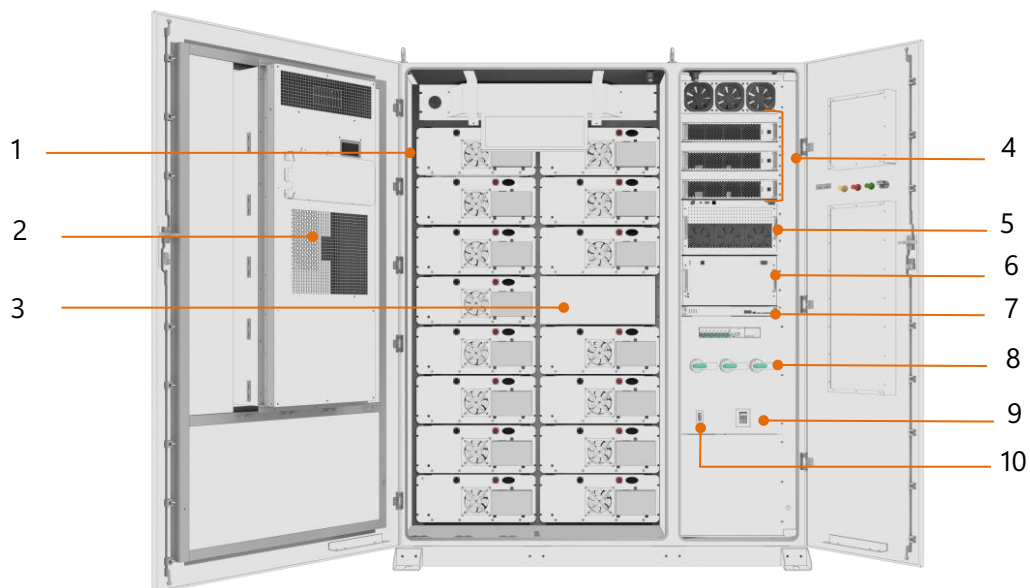

Figure 3-5 System internal diagram

Table 3-6 System internal composition

No.	Name	Functionality
1	Battery Module	For electrical energy storage
2	Air conditioner	Regulates the battery operating temperature to ensure that the battery operates at the optimal temperature
3	BMS module	Collect battery information and control battery charging and discharging
4	MPPT module (optional)	Maximizing PV power
5	PCS module	AC and DC bi-directional conversion
6	STS module (optional)	Automatic fast switching between grid and off-grid can be realized
7	EMS Module	Energy management and total control of the entire system
8	PV disconnect switch (optional)	Breaks and protects the PV side
9	Grid Switch	Breaks and protects the Grid side
10	Load switch (optional)	Breaks and protects the Load side

The BESS secondary electrical switches and external Ethernet ports are as follows:

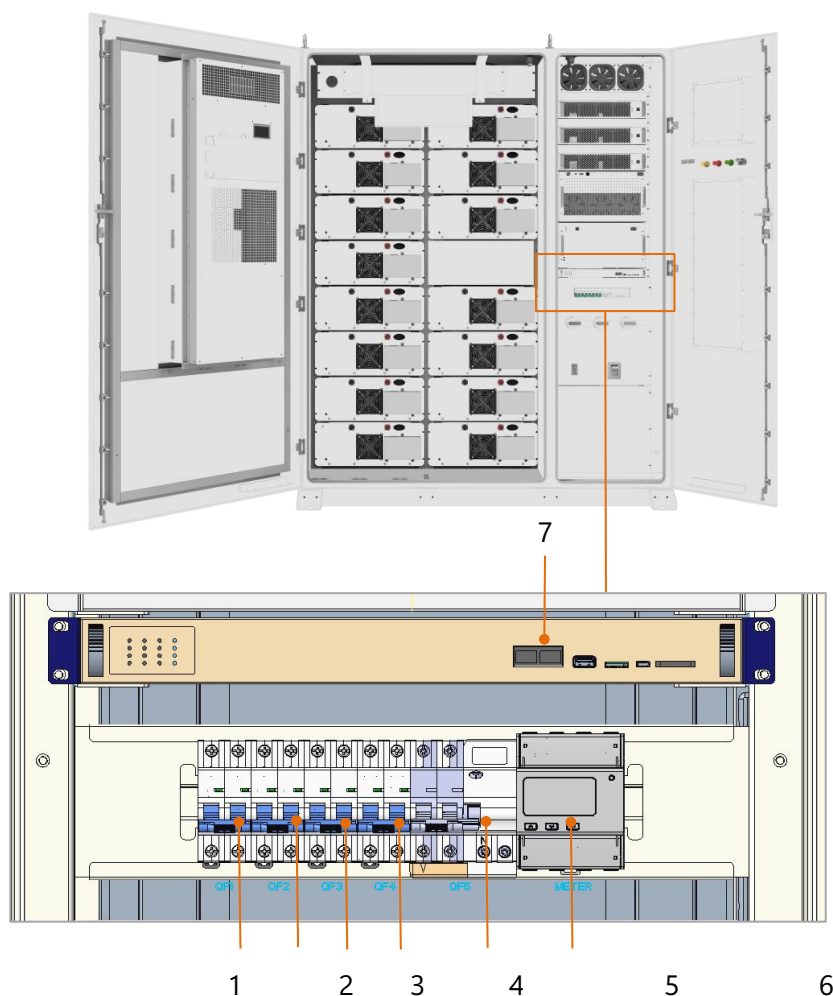

Figure 3-6 BESS secondary switch

Table 3-7 Ethernet Port Function Terminal

NO,	Name	Functionality
1	QF1	UPS input switch
2	QF2	Battery fan power switch
3	QF3	System secondary power supply switch
4	QF4	Socket switch
5	QF5	Air conditioning switch
6	METER	Three-phase meter
7	LAN1	Ethernet port

System parameters

The BESS parameters for each type of DH200F, including S150L00, S100L00, S050L00, S000L00, S150L01, S100L01, S050L01, and S000L01, are summarized in the following table:

Table 3-8 BESS Parameter Sheet

Battery system specification parameters: (Applicable to all models)	
Battery type	lithium iron phosphate (LiFePO ₄)
Battery capacity	280Ah
Single module battery configuration	1P16S
Number of packs	One cluster/15 modules
Battery voltage range	672~864V
Rated current	140A (0.5C)
Maximum current	150A
System storage capacity	215kWh
AC specification parameters (on-grid): (Applicable to all models)	
Rated power	100kW
Rated AC voltage	400V
Wiring method	3P4L+PE
Frequency	50Hz
Maximum AC current	158A
Maximum number of BESS units be paralleled	12
AC specification parameters (off-grid): (Applicable only to models S150L01, S100L01, S050L01, S000L01)	
Rated power	100kW
Rated AC voltage	400V
Wiring method	3P4L+PE
Frequency	50Hz
Maximum AC current	158A
Unbalanced load carrying capacity	100%
On-grid to off-grid switching time	<20ms
Off-grid to on-grid switching time	<20ms
Maximum number of BESS units be paralleled	5
PV access: (Applicable to all models, the "S" followed by a number represents the PV power. For example, S150L00 indicates a 3-channel MPPT with a power of 150 kW.)	
Input voltage	200-670V
Number of MPPT paths	0~3

MPPT Power	50kW per channel
System specification parameters: (Applicable to all models)	
Dimension (W*D*H)	1.85*1.2*2.25m
Weights	Approx. 3300kg ((based on the S150L01 model as a reference, actual weight may vary for other models received)
Air conditioner power	3kW (cooling capacity)
Working environment temperature	-20~50°C
Working environment humidity	0~95% (non-condensing)
Protection level	IP55
Anti-corrosion grade	C3
Noise	≤75dB
Elevation	≤3000m (Above 2000m need to reduce the amount)
Cooling method	Air cooling
Demonstrate	Touch screen (optional)
Fire-fighting	Optional: Aerosol/heptafluoropropane (FM-200)/perfluorohexanone (Novec1230)
EMS external communications	Ethernet
Certification	CE、CQC

Core Modules

Battery Modules



DANGER

- Do not touch any batteries while the BESS is running.
- Only authorized operators should handle the batteries
- End of life (should be decommissioned, disassembled and disposed of in accordance with the recycling program provided).

This product uses LFP battery modules (LiFePO₄), which have excellent safety, long service life, good temperature performance, high energy density, low cost, pollution-free modular assembly, high strength, and high structural reliability with low maintenance costs. The appearance of the battery module is shown below:

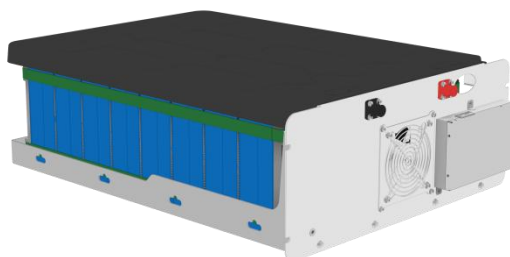

Figure 3-7 The appearance of battery module

Table 3-9 The parameters of battery module

Model number	HV51280F
String form	1P16S
Battery energy (kWh)	14.336
Nominal voltage (Vdc)	51.2
Nominal capacity (Ah)	280
Standard charging current (A)	140
Standard discharge current (A)	140
Maximum continuous charging current (A)	200
Maximum Continuous Discharge Current (A)	200
Dimension(W*D*H)	568*764*231mm
IP class	IP20
Operating temperature	Charging 0°C~+55°C
	Discharge -20°C~+55°C
Operating humidity	0%~95% RH (non-condensing)
Storage temperature	1 month -20~45°C
	1 year 0~35°C



WARNING

When a battery electrolyte leak is detected

- When battery leakage occurs, please stop using it immediately;
- The electrolyte is non-toxic and has little odor, if it contacts the skin it has some pathogenicity, please keep it away from the skin;
- When handling leaking batteries, make sure that the power supply connected to the battery is off to prevent fire and sparks, and wear rubber gloves when handling in a well-ventilated handling area;
- When the battery has an irritating and abnormal odor and it is impossible to determine whether there is electrolyte leakage, please stop using it immediately and isolate the battery.

Disposal of electrolyte

- When electrolyte leakage occurs, use gauze (ordinary medical gauze) or other liquid absorbent solids to clean the battery leakage;
- The treated battery should be placed in isolation and should not be used again.
- Please do not touch the electrolyte directly, if skin contact accidentally, please flush with plenty of water.

EMS

EMS (Energy Management System) is an essential component of energy storage systems. It works in conjunction with PCS, MPPT (optional), STS (optional), BMS, environmental

monitoring equipment, fire protection systems, electricity meters, air conditioning, or access control systems to form an energy storage system. EMS controls the entire system and enables functions such as on-grid and off-grid control, peak shaving and valley filling, demand control, smoothing of renewable energy fluctuations, dynamic expansion, and optimizing energy storage revenue. EMS collects data and signals from local devices and ensures the safe, reliable, efficient, and economical operation of the energy storage system through internal control strategies.

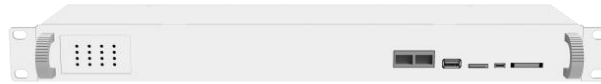

Figure 3-8 The appearance of EMS

The EMS parameters and interfaces are as follows

Table 3-7 EMS Interface Parameter Sheet

Program	Specification	clarification
Control Functions	Dynamic voltage regulation, peak shaving and load shifting, demand control, dynamic capacity expansion	
User interface	10.1" monitor interface	
SD	SD Card Interface	
USB-HOST	USB flash drive interface	For software upgrades
RST	Reset port	For local controller reset
Communications interface	2x Ethernet, 8x RS485, 2x CAN, 1x 4G	
Communications protocol	Ethernet: Modbus TCP, IEC61850 MMS RS485: Modbus RTU CAN: Function reservation	
DI Input	16 channels, internal self-power supply, support passive dry contact input signals	Passive dry contact signal
DO Output	16 channels, support normally open/normally closed	Relay output, relay size: 250Vac/3A or 30Vdc/3A
Indicator light	Power indicator, operation indicator, alarm indicator, communication indicator, etc.	

BMS

BMS module is a high-voltage power circuit management unit specially designed for energy storage system by our company, which is an intermediate unit connecting battery clusters and energy storage converter. The BMS module is equipped with circuit breakers, contactors, fuses, current sensors, battery cluster control management module (HVBCU), switching power supply, etc. It performs functions such as voltage and current acquisition, circuit contactor control, and protection for battery clusters.

The BMS stabilizes and secures the battery function by monitoring the battery status in

real time, and prolongs the service life of the battery by monitoring the consistency of the battery.

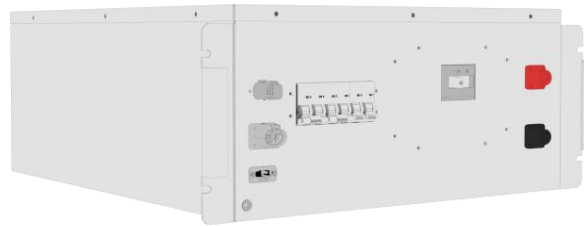

Figure 3-9 The appearance of BMS

PCS

PCS Function: The PCS (Power Conversion System) is a bidirectional current-controllable device that connects the energy storage battery system to the grid. Its main functions are to facilitate energy exchange between the battery and the grid, and to control and manage the charging and discharging of the battery. It enables bidirectional conversion between DC and AC, allowing for both AC-to-DC conversion to charge the battery and DC-to-AC conversion to supply power to loads or feed back to the grid.

PCS Model: The PCS used in this system is the EPCS105-AM model, which adopts a three-level topology structure and has a rated output power of 105 kW

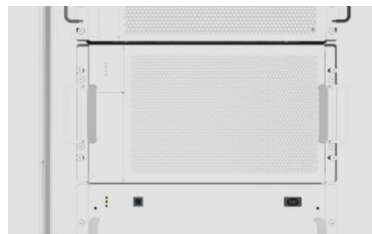

Figure 3-10 The appearance of PCS

Fire protection systems

The system is equipped with an efficient and reliable fire suppression system that automatically activates and extinguishes fires upon detection.

The product is equipped with a composite detector (incorporating smoke, temperature, and gas detectors) and fire extinguishing agent on the top of the battery compartment. Optionally, a water immersion sensor is installed at the bottom of the battery compartment. When any of the three detectors in the composite detector detects an anomaly, the system will stop operating and report the anomaly. If two detectors detect anomalies, the fire extinguishing agent will be released to suppress the fire, and a feedback signal will be sent to the EMS which can further relay the information to site monitoring or the user. In the event of an anomaly detected by the water immersion sensor, the system will also stop operating and report the anomaly.

The block diagram of the fire protection system is shown below:

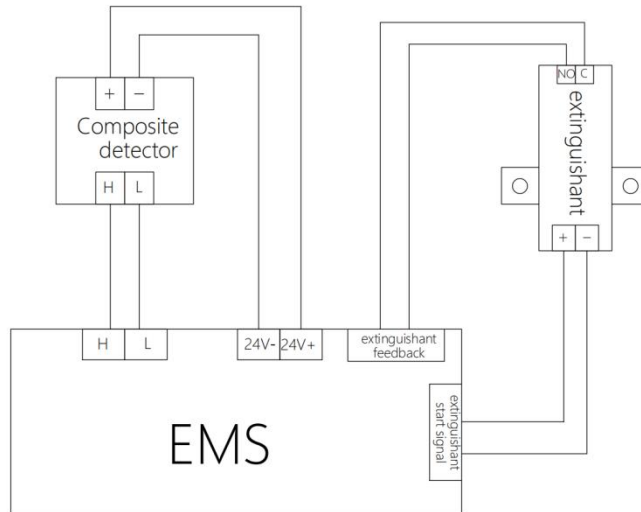

Figure 3-11 Fire Protection System Schematic Diagram

The maintenance of the fire protection system should comply with the fire codes and regulations of the country/region where the project is located. Fire protection equipment should be inspected and maintained regularly to ensure that all functional indicators are normal.

Application Scenario

Peak-load shifting

This scenario is suitable for areas with significant price differences between peak and off-peak electricity rates. Users can set peak and off-peak periods based on local time-of-use pricing policies, their electricity usage patterns, and consumption levels. The energy storage system charges during off-peak hours when electricity prices are low and discharges during peak hours, effectively shifting electricity consumption in time and reducing the user's electricity costs.

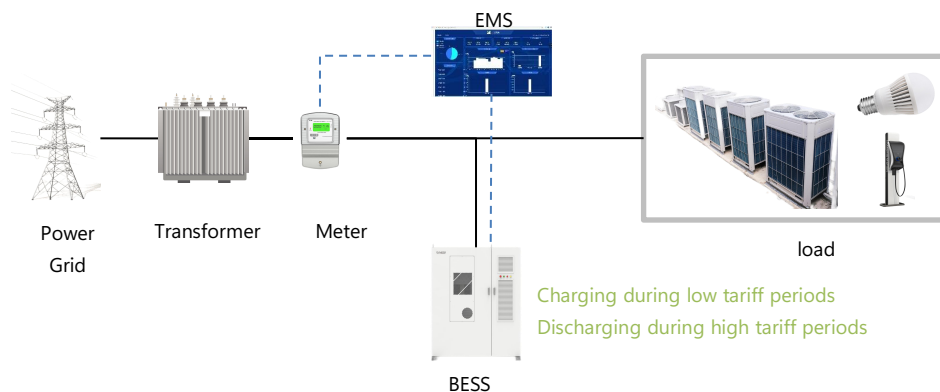

Capacity and Demand Reduction

This scenario is suitable for large-scale industries with high electricity consumption and adopting a two-part tariff system.

By using an energy storage power station, it is possible to reduce the monthly fixed capacity or demand charges for users, lower their basic electricity costs, defer the need for distribution capacity expansion, and reduce investment costs.

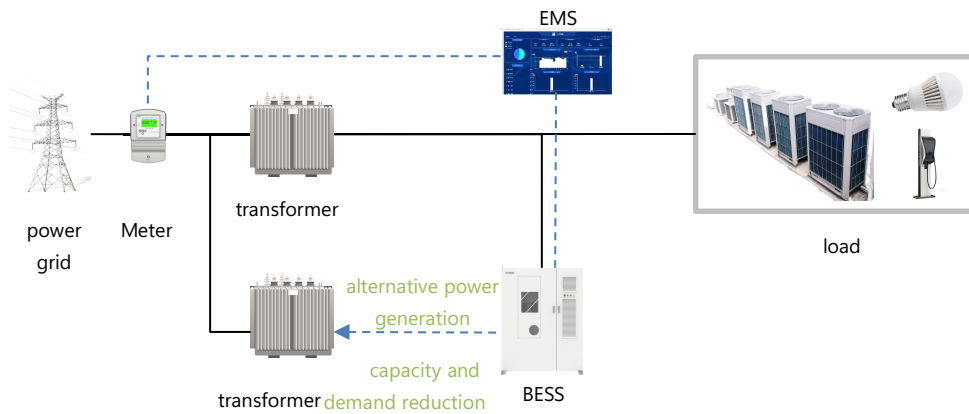

Enhance Consumption

This scenario applies to areas where distributed electric energy has been installed or will be installed.

When the load is low, the storage power station gives priority to storing distributed new energy (photovoltaic/wind power) power generation and discharging it at the appropriate time, which reduces the new energy feed-in power, improves the rate of consumption, and maximizes the user's benefit.

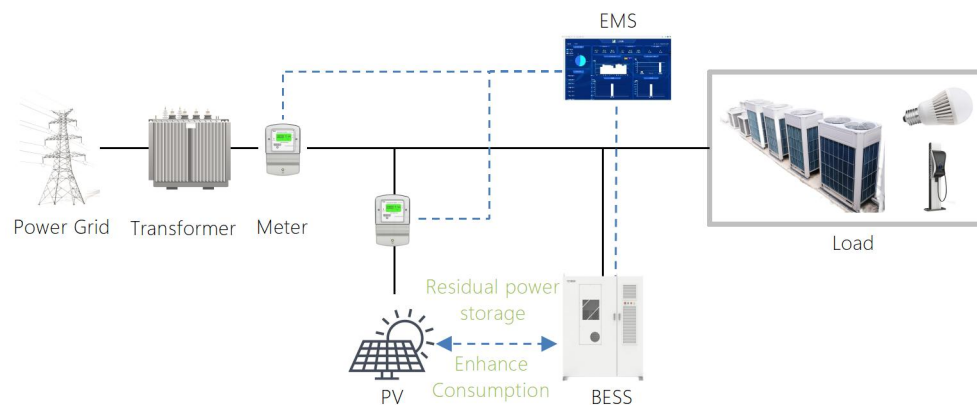

Demand-side response

According to local policies, energy storage is used as a controllable load/energy to actively respond to grid dispatch demand and gain response subsidy benefits.

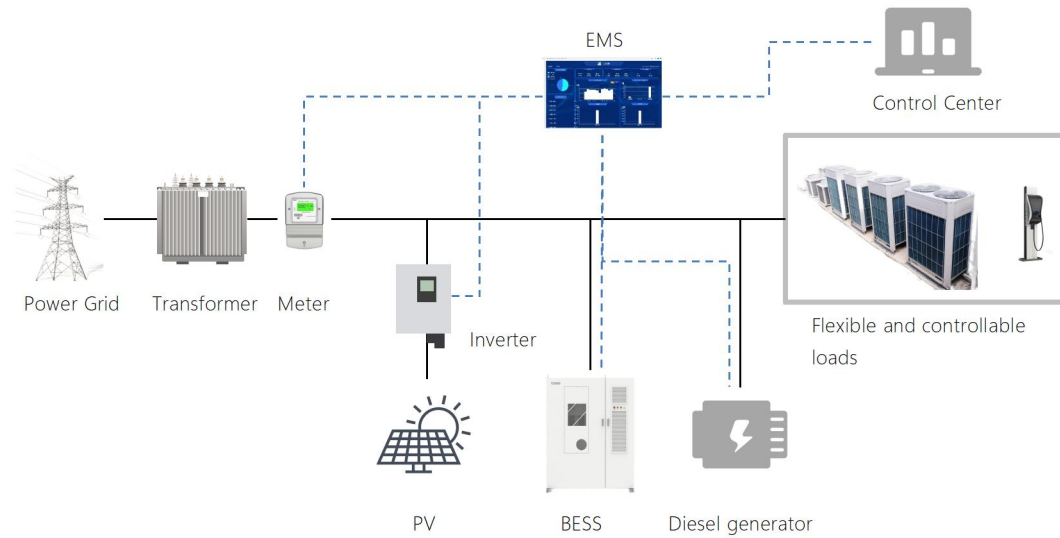

Backup Power

BESS can stabilize the user voltage and serve as an emergency backup power source, further ensuring the safe and stable operation of the load and minimizing the adverse effects of power quality issues or outages on production and daily life.

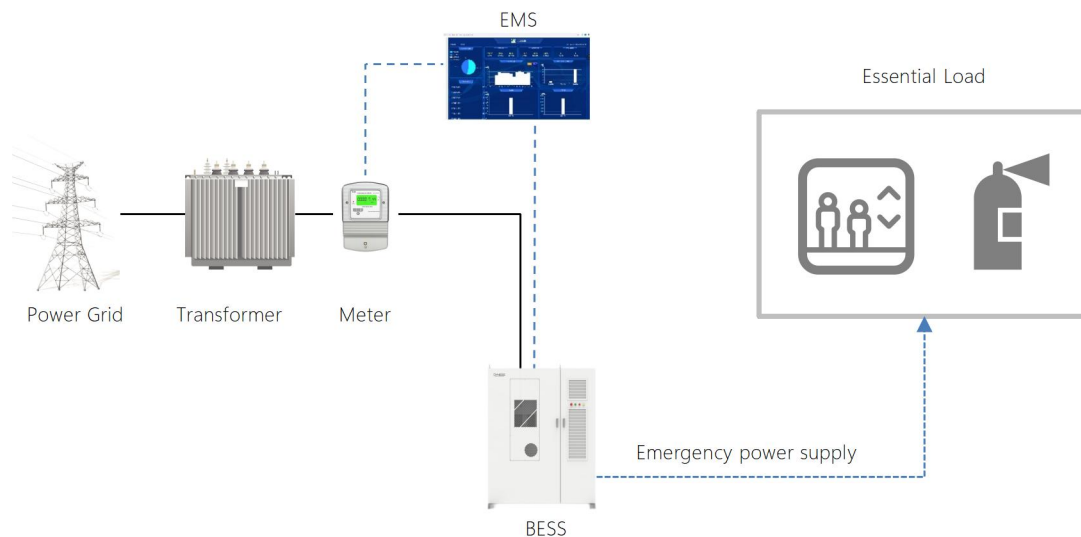

4 Delivery, transportation and storage

Caution: Failure to transport and store in accordance with the requirements of this manual may void the warranty.

Table 4-1 Scope of delivery

No.	Name	Quantity	Note
1	DH200F	1	Please refer to the "Delivery List" for specific product components.
2	User Manual	1	Electronic version
3	Warranty Letter	1	
4	Certificate of Conformity(CoC)	1	

Unpacking and Inspection

- After receiving the product, please check whether all the delivered components are complete against the "supply list".
- Please check whether the actual received cabinet and the received product model is the same as the ordered model.
- Carefully check whether the product is intact, the transportation process may lead to equipment collision caused by damage, if you find problems, please contact our company or the transportation company in a timely manner.

Shipping Requirements

- All necessary equipment in the product have been installed and fixed in the cabinet before leaving the factory, and the product can be transported as a whole during transportation.
- Please confirm that the cabinet doors of the equipment are tightly locked before transportation.
- Be sure to set up warning signs or caution tape to prevent unauthorized personnel from entering the lifting and transportation area to avoid accidents.
- Remove any existing or potential obstacles during the moving process, such as trees, cables, etc.
- Whenever possible, choose favorable weather conditions for transporting the equipment.

Requirements for equipment transportation mobility

Equipment transportation needs to meet the following conditions::

- Select a suitable crane or lifting tool according to the site conditions. The selected tool must have sufficient sufficient load-bearing capacity, arm length, and rotation radius.
- If movement on slopes or similar conditions is required, additional traction devices may be necessary.

When carrying out ground transportation, be sure to use ropes to secure the top lifting ring of the equipment to the transport vehicle to prevent excessive tilting during transportation.



WARNING

- Throughout the loading, unloading, and transportation process, it is essential to comply with the outdoor cabinet operation safety regulations of the country/region where the project is located!
- Any machinery used in the operation of the product should be maintained.
- All personnel involved in loading, unloading and bolting should be trained accordingly, especially in safety.

Forklift transport

The bottom of this product is equipped with fork holes specially designed for forklift transportation. The front and back panels can be removed to reveal the sockets. The product can be moved through the bottom fork holes on the front and back. If the installation site is flat, the product can be moved using a forklift. Forklift transportation methods should meet the following requirements:

- The forklift should be equipped with sufficient load capacity.
- The length of the pins should meet the requirements of the equipment.
- The pins should be inserted into the fork holes at the bottom of the workstation.
- When products are transported, moving and lowering should be slow and steady.
- Only place the product in a smooth place. The place should be well drained and free of any obstacles or bulges.
- Under no circumstances should the unit be moved by inserting the pins into a position other than the fork holes

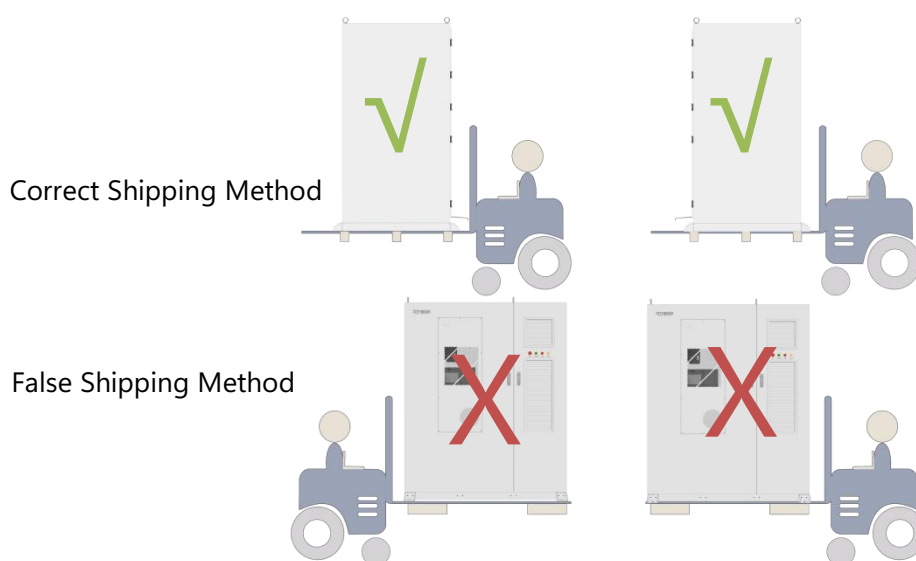

Figure 4-1 Forklift Transport Diagram

Lifting and transportation

This product is equipped with a lifting ring at the top for lifting, and can be transported by lifting. When lifting the equipment, at least the following requirements must be met:

- Ensure site safety when lifting.
- When lifting and installing, professional personnel should be in charge of the whole process.
- The strength of the slings used should be able to withstand the weight of the equipment.
- Ensure that all sling connections are safe and reliable, and ensure that each section of the sling connected to the corner piece is of equal length.
- The length of the slings can be adjusted appropriately according to the actual requirements of the site.
- Make sure that the equipment remains stable and does not tilt during the lifting process.
- Take all necessary auxiliary measures to ensure the safe and smooth lifting of the equipment.



Figure 4-1 Lifting and Transportation Diagram

Storage Requirements

Storage Environment Requirements:

- To prevent condensation inside the product or soaking of the bottom of the product during the rainy season, the product should be stored on higher ground.
- The product should be stored on dry, flat, solid ground with sufficient load-bearing

capacity and without any vegetation cover. The storage ground should be flat, no water accumulation, no bumps or unevenness, and the flatness should be no more than 5mm.

- Storage environment temperature: 0°C~+35°C, storage environment relative humidity: 0~95%, no condensation.
- Pay attention to cope with the harsh environment around, such as sudden cold, sudden heat, collision, etc., so as not to cause damage to the Pack.
- The air inlet and outlet of the product should be effectively protected, while effective measures should be taken to prevent rain, sand and dust from intruding into the interior of the cabinet.

Storage Operating Requirements:

- Packing boxes should not be tilted or inverted.
- Make sure that the cabinet doors and internal equipment cabinet doors are securely locked before storage.
- Must raise the base of the cabinet, the specific height of elevation should be determined reasonably according to the site geology, weather and other conditions. Additionally, heating should be provided for internal equipment in low-temperature environments.
- For products stored for a long period (more than six months), perform a visual inspection by opening the cabinet doors. Check for any condensation on the exterior of the cabinet and ensure the cabinet and internal equipment are intact. Additionally, perform checks after powering on and starting up. If necessary, professional testing should be conducted before installation.
- Perform regular inspections at least every two weeks to check the cabinet and internal equipment for any damage. Prevent insect or rodent infestation. If any damage is found, replace the packaging immediately.



NOTE

- Starting from the date of delivery, if the storage period for the PACK exceeds six months under the above conditions, perform one charge and discharge cycle to achieve a system SOC of 30% to 40%. After recharging, maintain consistent SOC levels.

5 Installation

Pre-installation inspection



WARNING

Please comply with local safety regulations and operational rules during installation. Only complete and undamaged equipment can be installed! Please ensure that before installation:

- The product cabinet itself should be complete and intact.
- All equipment in the cabinet should be complete and intact.

Installation environment requirements

Site selection requirements:

- When selecting the installation site, full consideration should be given to the surrounding environment (climate and geological conditions, such as stress wave emission, underground water level, no high cables in the vertical upper part of the installation site, no pipelines or other underground facilities in the lower part of the installation site, and a certain safety distance should be maintained between the equipment and buildings and people, the length of the distance should be subject to the fire safety regulations of the project).
- The surrounding environment should be dry and well ventilated.
- Please ensure that there are no trees around the installation location to prevent branches or leaves from blocking the doors or air inlets of the energy storage integrated system during strong winds.
- The installation location should be away from toxic and harmful gas and flammable, explosive, corrosive, and dust-intensive materials.
- The installation location should be away from residential areas to avoid noise.

Foundation requirements:

- The foundation should provide sufficient load-bearing support for the equipment.
- The height of the foundation should be higher than the historical highest flood level.
- The basic bearing capacity is $> 3t/m^2$, the Basic service life is > 20 years, and the basic level is $3mm/m^2$.
- The product cabinet should be raised to against the rain. The recommended mounting height of the base is about 300mm-500mm higher than the ground.
- Drainage measures should be constructed according to local geological conditions.

Wiring requirements:

- According to the positions and dimensions of the inlets and egress point of the cable at the bottom of the cabinet, sufficient space should be reserved for the AC side cable trough and the cable guide should be inserted in advance during foundation construction.
- The specifications and quantity of perforated pipes are based on the cable model and quantity of the cable.

- Both ends of all embedded pipes are temporarily sealed to avoid impurities from entering. Otherwise, later wiring is inconvenient.
- After connecting all the cables, inlets, outlets and connectors of the cable should be sealed with refractory clay or other suitable material to avoid entry of rodents.
- Please comply with local safety regulations and operational rules during the process of ground cables embedding.

Installation space requirements:

Make sure that the equipment has enough space for better cooling and maintenance, you are advised to reserve enough space around the cabinet installation position.

- The reserved space in front of a single product should not be less than 1300mm.
- The reserved space behind a single product should not be less than 800mm.

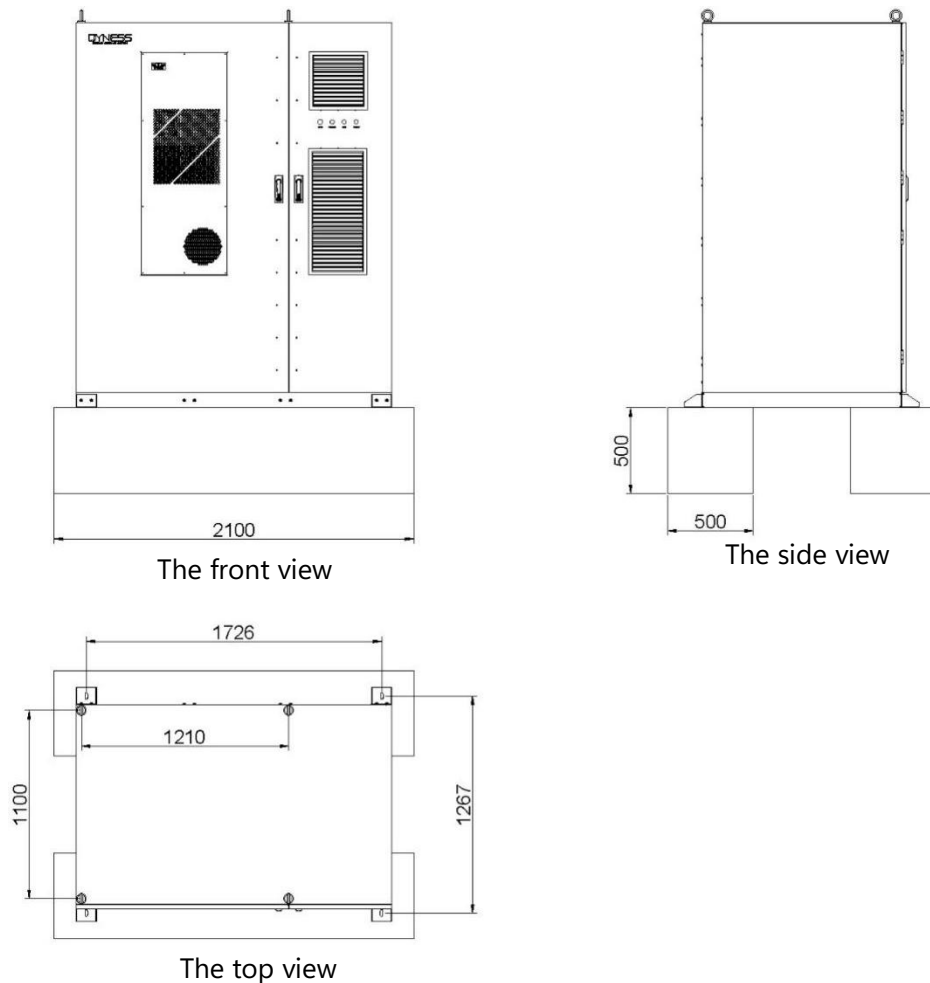

Figure 5-1 Installation Space Requirements

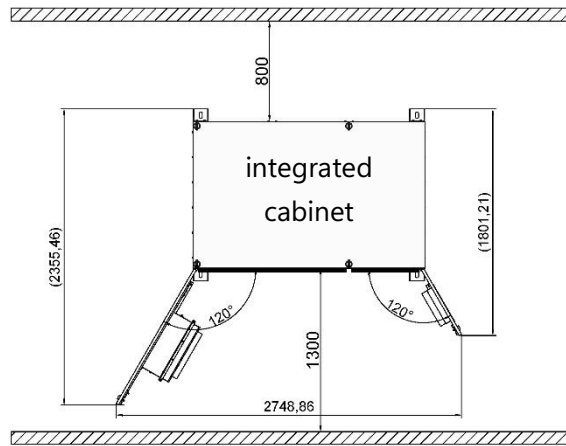

Figure 5-2 Illustration of rack fixing

The capacity of BESS integrated cabinet can be freely configured according to demand and can be expanded to MW level. The parallel installation has different layout according to on-grid and off-grid schemes, and the installation space requirements are as follows:

In the on-grid solution, the space requirements for parallel installation are as follows:

- Up to 12 units of the BESS integrated cabinet can be parallelly installed, expandable up to 2.5 MWh.
- The BESS integrated cabinet can be seamlessly interconnected on both sides.
- When arranged in a single row, the reserved space in front of the parallel BESS integrated cabinets should not be less than 1300mm, and the rear space should be no less than 800mm.
- When arranged in two rows, the reserved space in front of the parallel BESS integrated cabinets should not be less than 1300mm for each row, and a minimum of 800mm space should be reserved between the two rows for maintenance and inspection by technicians.

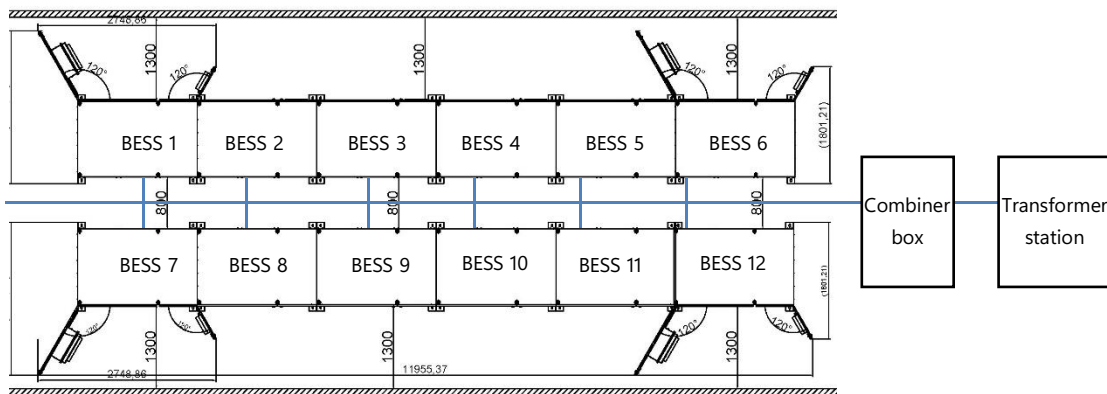

Figure 5-3 BESS parallel installation space requirements (on-grid scheme)

In the off-grid solution, the space requirements for parallel installation are as follows:

- Up to 5 units of the BESS integrated cabinet can be parallelly installed, expandable up to 1 MWh.
- The BESS integrated cabinet can be seamlessly interconnected on both sides.
- There should be a minimum clearance of 1300mm at the front of the BESS integrated cabinet where the cabinet doors open.
- There should be a minimum clearance of 800mm at the back of the BESS integrated cabinet for proper spacing.

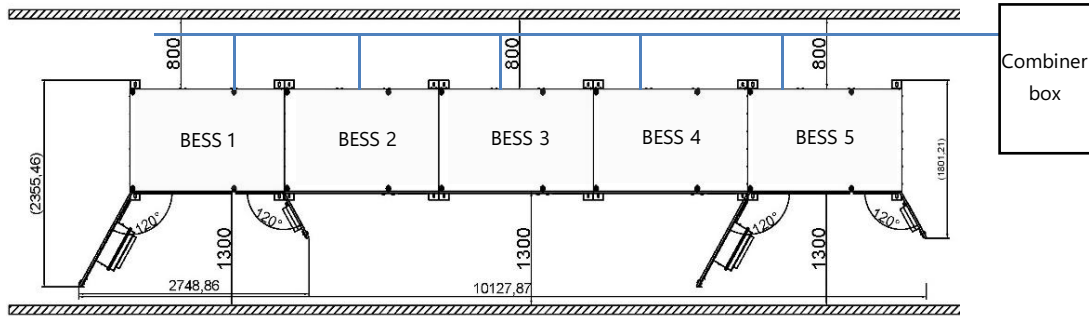

Figure 5-4 BESS parallel installation space requirements (off-grid scheme)

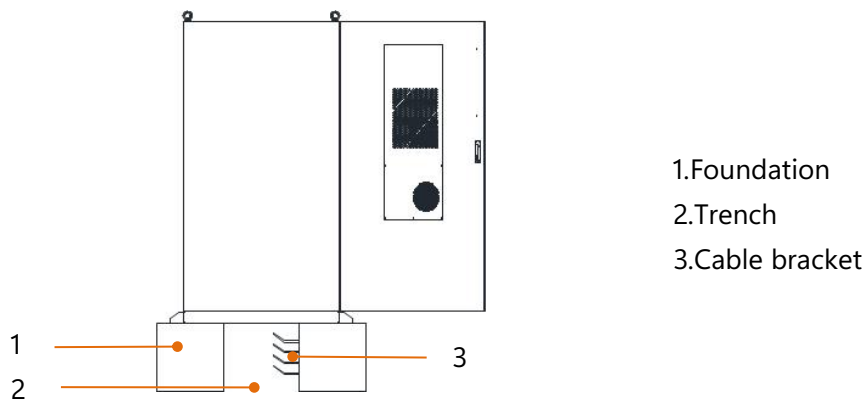

Figure 5-5 Illustration and description of the trench interface

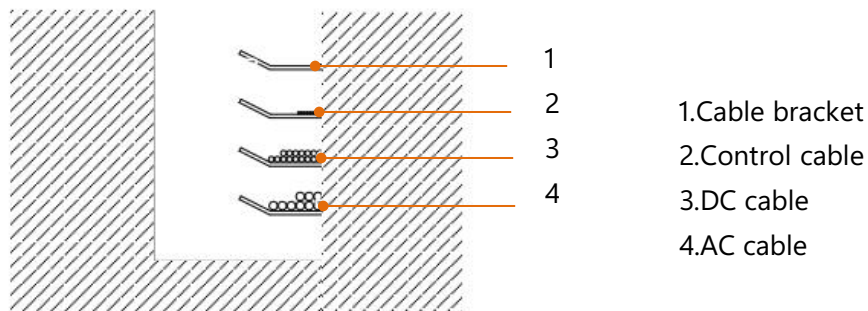



Figure 5-6 Schematic and description of cable bracket

Wiring

Only qualified electrical engineers are qualified for electrical connections. Please follow the requirements given in "Safety Instructions" in this manual. We cannot accept liability for personal injury or property damage caused by ignoring these safety instructions.

The installation design of the product must comply with the relevant standards or regulations of the country/region where the project is located.

If the installation is not carried out in accordance with the installation design requirements given in this manual, resulting in product or system failure, the warranty will not be covered.



DANGER

- Do not touch live parts.
- Before installation, please ensure that the AC and DC sides are not powered on. All electrical connections must be made when the equipment is completely unenergized.
- Before wiring, the polarity of all input cables must be checked to ensure that the polarity of each input is correct.
- Do not place the equipment on flammable surfaces.

WARNING

- The entry of sand and moisture may damage the electrical equipment in the energy storage system or affect the performance of the equipment.
- During the sandstorm season, or when the relative humidity in the surrounding environment is greater than 95%, Electrical connection should be avoided.
- The connection can be started when there is no sand, and the weather is clear.
- During the electrical installation, do not pull the cables or wires hard so as not to damage their insulation properties.

-

CAUTION

- Be sure that all cables and wires should have a certain elasticity.
- Please take necessary auxiliary measures to reduce the pressure on the cables or conductors.
- After each step of wiring, it is necessary to check carefully to ensure that the wiring is correct and firm.
- All electrical connections must be made in strict accordance with the wiring diagram.

Wiring Tools

Protective items are shown below:



Figure 5-7 Safety Gear

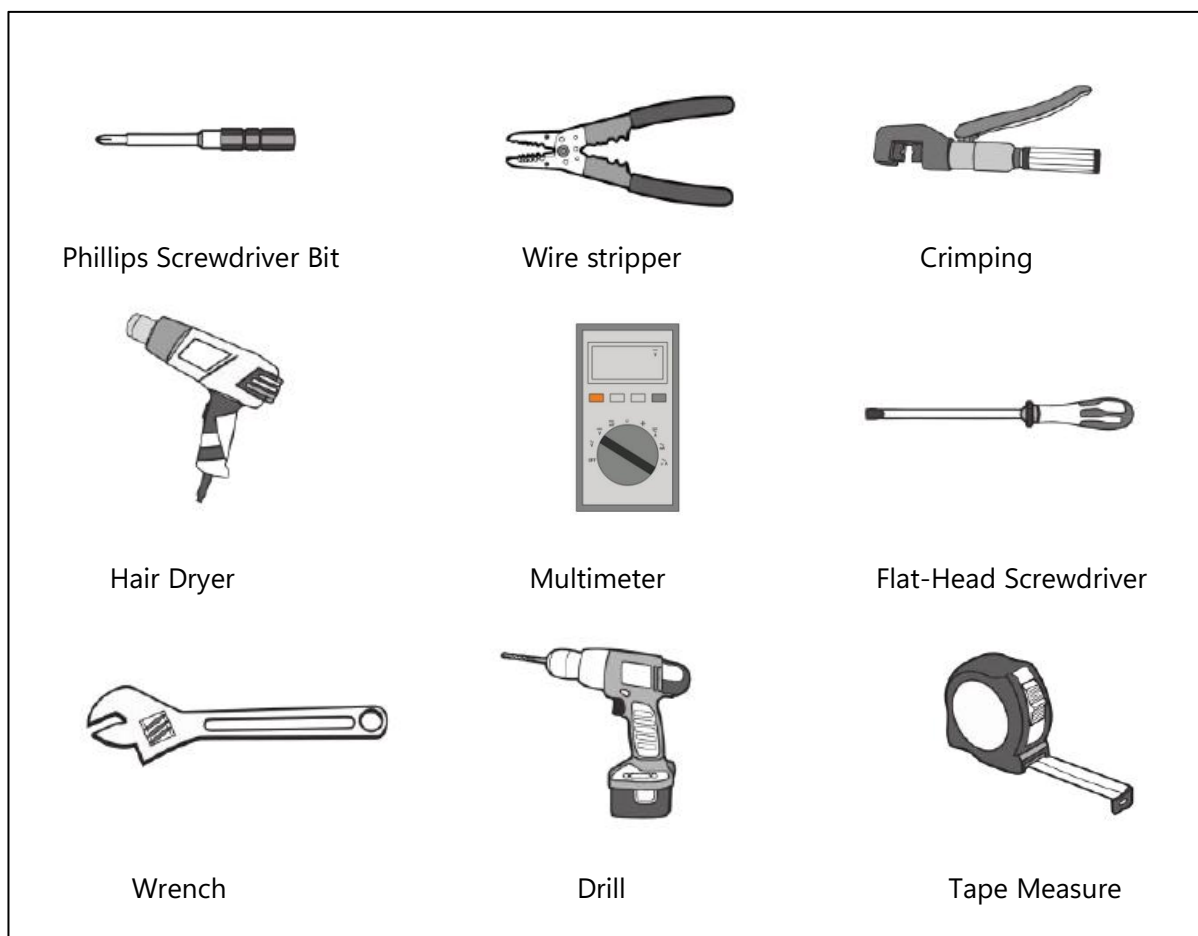

Figure 5-8 Tools

Wiring Wire Instructions

Upon receipt of this product, open the lowest panel on the right side of the cabinet and will see the wiring area in the electrical compartment as shown below:

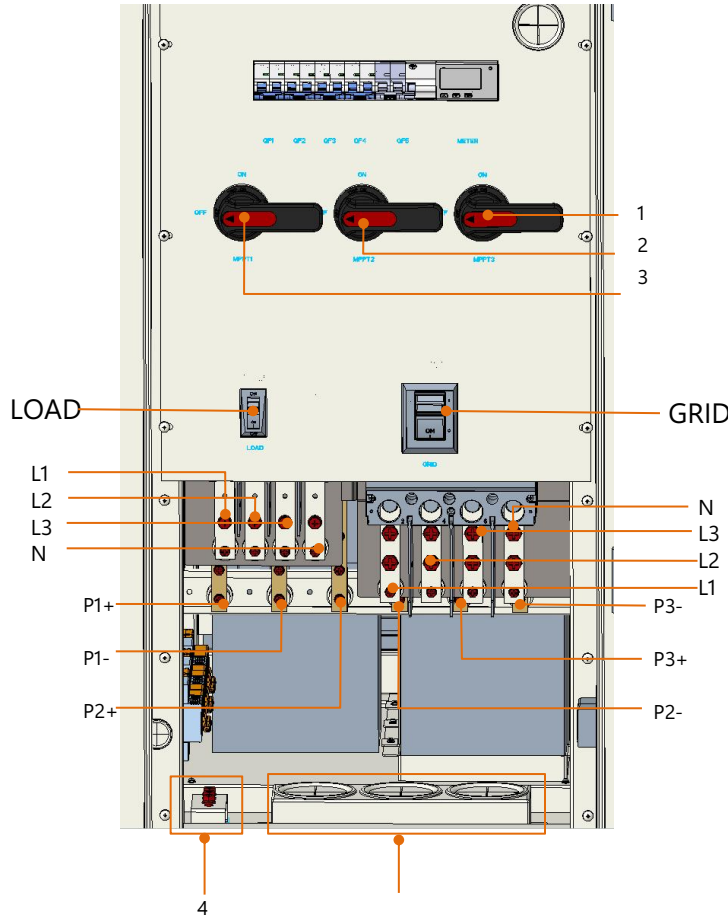

Figure 5-9 Wiring Area Diagram

- 1: PV1 disconnecting switch
- 2: PV2 disconnecting switch
- 3: PV3 disconnecting switch
- 4: Grounding copper row
- 5: Outlet holes

GRID: Grid-side circuit breaker

LOAD: Load side circuit breaker

- L1: Firewire L1
- L2: Firewire L2
- L3: Firewire L3
- N: Zero line

- P1+: PV1 positive terminal
- P1-: PV1 negative terminal
- P2+: PV2 positive terminal
- P2-: PV2 negative terminal
- P3+: PV3 positive terminal
- P3-: PV3 negative terminal

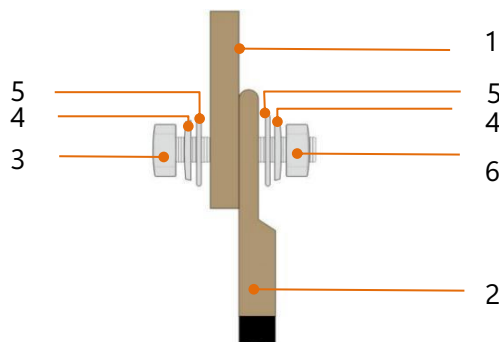

Figure 5-10 Copper End Schematic

- 1.Copper row
- 2.Terminal block
- 3.Bolt
- 4.Spring pads
- 5.Flat washers
- 6.Nut

The cable and terminal requirements are as follows:

Table 5-1 Adapted cable/terminal table

No.	Typology	Wiring specifications	Terminal Specifications
1	LOAD(Optional)	ZR-YJV 50mm ²	OT/DT50-8
2	GRID	ZR-YJV 95mm ²	OT/DT95-10
3	PV1(Optional)	ZR-YJV 16mm ²	OT/DT16-8
4	PV2(Optional)	ZR-YJV 16mm ²	OT/DT16-8
5	PV3(Optional)	ZR-YJV 16mm ²	OT/DT16-8
6	GND	ZR-YJV 50mm ²	OT/DT50-8

Description of installation procedures

Step 1 Open the cabinet door before connecting the cables

1. Make sure that the equipment is under lock state.
2. Moving the lid up above the locking hole.
3. Getting the key in the door and revolve it clockwise.
4. Rotating the handle clockwise to the position shown in the figure to open the front door.

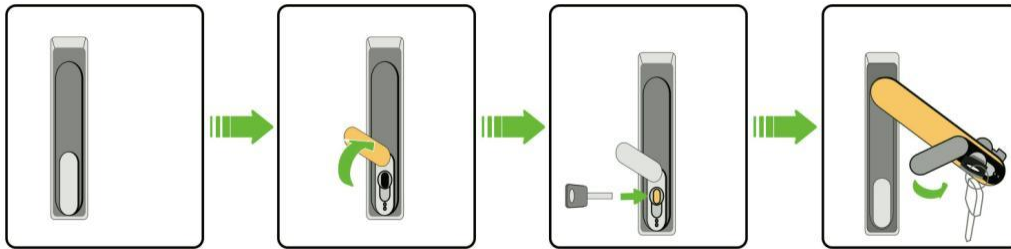

Figure 5-11 steps before opening the door

Step2: Cables Preparation

The selected cables must meet the following requirements:

- Having sufficient current carrying capacity. The current carrying capacity of a conductor include the main but are not limited to the following factors:
 - Environmental conditions
 - Type of conductor insulation material
 - The way of cable laying
 - Material and cross-sectional area of cables
- The wire diameter of the cable must be selected according to the maximum current carrying capacity, and the length must have an allowance.
- The specifications and materials of three-phase AC output cables should be consistent.
- Be sure to choose flame-retardant cables.
- The cables used must comply with local laws and regulations.
- The color of the cables shown in this manual are only suggestions. Please select

the cables according to local cable standards.

Step 3: Cable Entry

If copper cable is selected, the connection sequence of wiring components is shown as follows:

- Trip off the insulation skin from the cable terminal, and the length of which should be the depth of the wire hole on the copper terminal, plus an additional 2-3mm.
- Install the heat-shrink sleeve at the cable terminal and insert the exposed copper core part of the stripped wire into the wire hole of the copper terminal (OT/DT terminal).
- Use hydraulic pliers to firmly crimp the copper terminally.
- Slide the heat-shrink tube onto the copper terminal (OT/DT terminal) to fully cover the wire hole. Use a heat gun to tighten the heat-shrink tube.

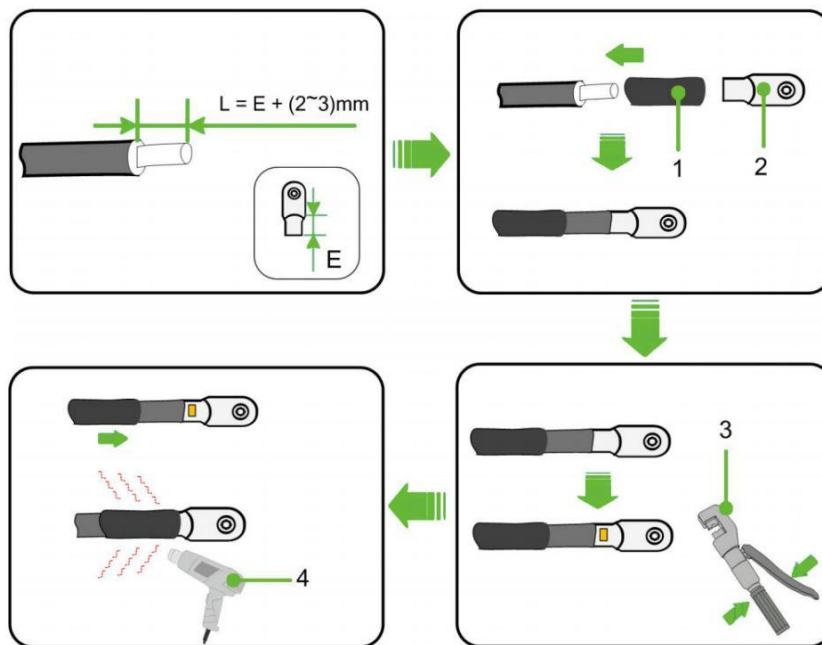

Figure 5-12 The connection sequence of wiring components

- 1: Heat-shrink tube
- 2: OT/DT terminal
- 3: Crimping Pliers
- 4: Hot air gun

Step 4 Grounding protection

The grounding method must comply with local standards and regulatory requirements.

Please consider the actual situation at project site and follow the instructions of the power station staff during the process of ground connection. After the grounding connection, the grounding resistance must be measured, and the specific grounding resistance value must comply with relevant region/local standards and regulations.

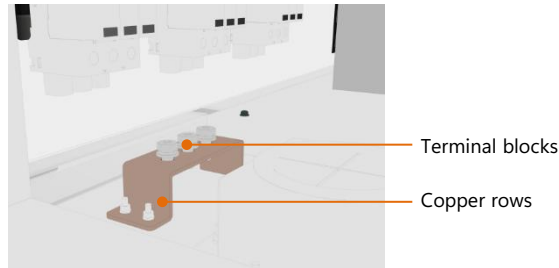

Figure 5-13 Illustration of ground cables

Cable wiring steps

Table 5-2 Installation steps for different wiring methods

Wiring methods	Wiring steps
GRID wiring	<ol style="list-style-type: none"> 1. Turn the GRID AC circuit breaker "GRID" to OFF and measure with a multimeter to ensure that there is no voltage at the terminals. 2. Bring the cable into the inlet hole and enter the AC wiring area of the electrical cabinet. 3. Ensure that the AC cable connections L1, L2, L3 and N are in the correct order. 4. Use wire strippers to strip the protective layer of the cable to expose the copper core. 5. Crimp the OT terminals, refer to "Cable and Terminal Requirements" in this chapter. 6. Use M10 bolts to fasten the OT terminal to the wiring hole, with a tightening torque of 21N.m. 7. After the wiring is completed, gently tug the cable to ensure that there is a margin.
LOAD Wiring (Optional)	<ol style="list-style-type: none"> 1. Turn the LOAD AC circuit breaker "LOAD" to OFF and measure with a multimeter to ensure there is no voltage at the terminals. 2. Bring the cable into the inlet hole and into the electrical cabinet AC wiring area. 3. Ensure that the AC cable connections L1, L2, L3 and N are in the

- correct order.
4. Use wire strippers to strip the protective layer of the cable to expose the copper core.
5. Crimp the cable using the OT terminals, refer to "Preparing the Cable" in this chapter.
6. Use M8 bolt to fasten OT terminal to the wiring hole with a tightening torque of 13N.m.
7. After the wiring is completed, gently tug the cable to make sure there is a margin.

PV Wiring
(Optional)

1. Turn the PV DC circuit breaker "MPPT" to OFF and measure with a multimeter to ensure there is no voltage at the terminals.
2. Bring the cable into the inlet hole and into the PV DC wiring area of the electrical cabinet.
3. Make sure the DC cables are connected to the P+ and P- terminals in the correct order.
4. Use wire strippers to strip the protective layer of the cable to expose the copper core portion.
5. Crimp the cable using the OT terminal, refer to "Preparing the Cable" in this chapter.
6. Use M8 bolt to fasten the OT terminal to the wiring hole with a tightening torque of 13N.m.
7. After the wiring is completed, gently tug the cable to make sure there is a margin.

Be sure to strictly follow the terminal phase sequence wiring. After all electrical connections are completed, the wiring should be thoroughly and carefully checked. At the same time, the following operations are also required:



WARNING

- Use fireproof and waterproof materials to tightly seal the outdoor cabinet inlet and outlet holes and the gaps around them.
- Lock the cabinet door and box door: follow the opposite steps of the "Open the cabinet door before connecting the cables" method, lock the cabinet door and pull out the key.
- Make sure that the sealing strip around the door is not curled after the door is closed!

Communication interface wiring

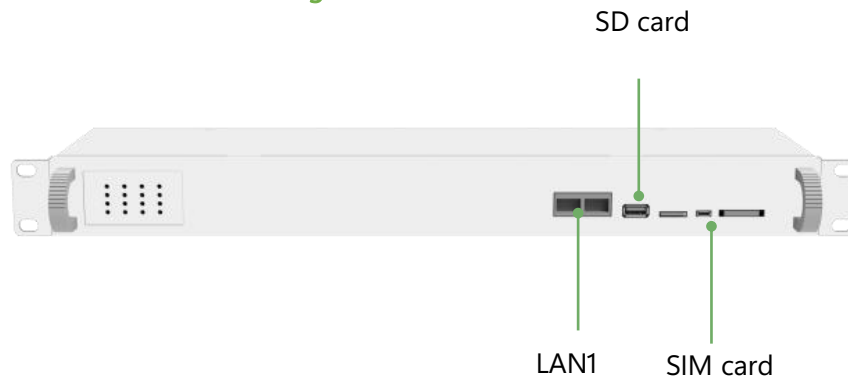

LAN1: Connection to Ethernet or user's local host computer

SD card: data storage and export

SIM card: insert SIM card when connecting to the cloud platform via 4G.

In addition, according to different application scenarios of customers, this system may have dry contact signals and RS485 communication to connect with other devices of customers, these interfaces are non-standard, if necessary, the system will lead the corresponding interface near the front panel for easy wiring.

6 System Running And Stop

Product power-on process

Precautions:

- The product can only be put into operation after being confirmed by professionals and approved by the local power department.
- For products with a long shutdown time, before powering on, a comprehensive and detailed inspection must be carried out on the equipment to ensure that all indicators meet the requirements before powering on.

Power-on inspection: Before powering on, please check the following items carefully to make sure they are correct.

- Check that the wiring is correct.
- Check if the emergency stop button is released.
- Check to make sure there are no ground faults.
- Use a multimeter to check whether the AC and DC side voltages meet the start-up conditions and there is no risk of overvoltage.
- Check to make sure no tools or parts are left inside the device.

Operating procedures:

The product power-on process is divided into 6 steps:

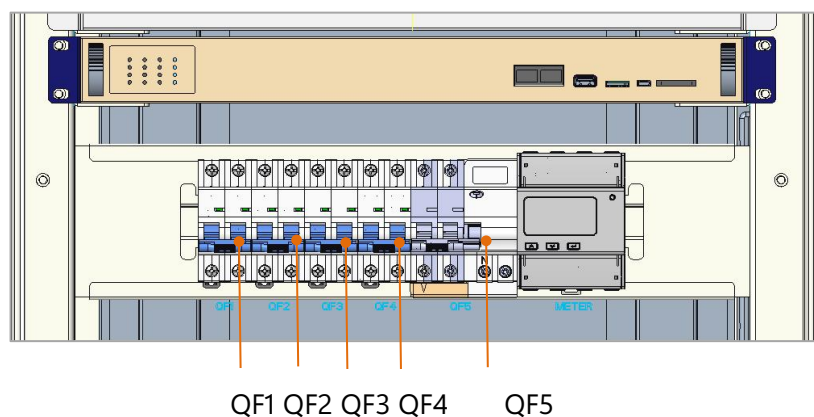
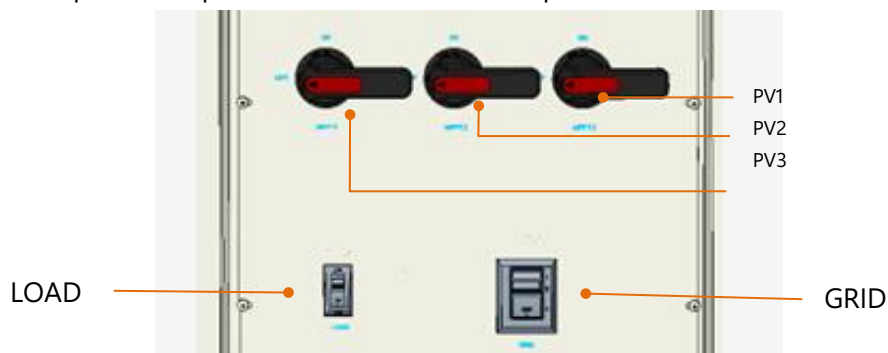

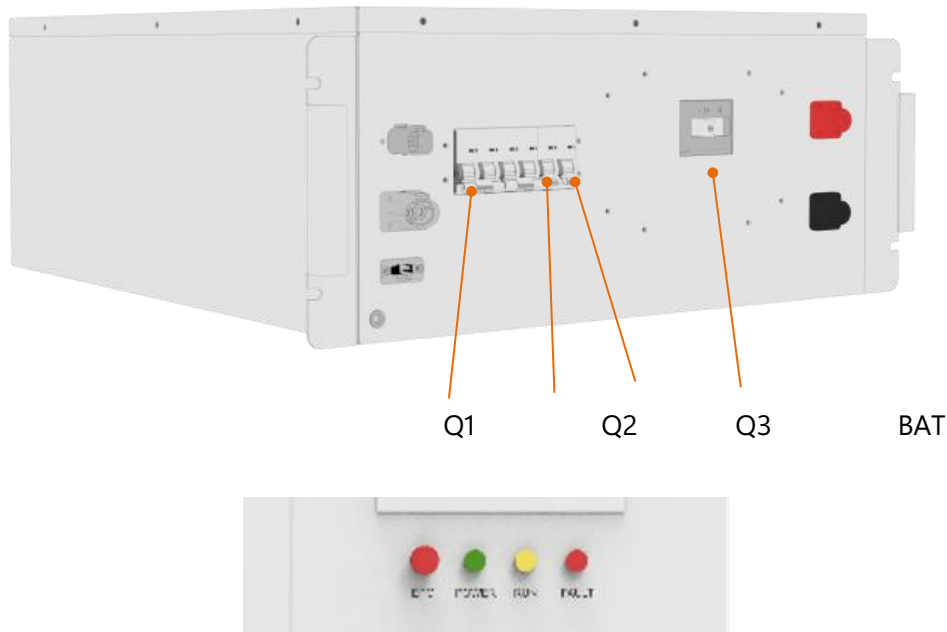

- Step 1: Turn on the "GRID" (AC circuit breaker)
- Step 2: Turn on the "LOAD" (load side circuit breaker)
- Step 3: Turn on "QF1" to "QF5" (each secondary circuit breaker) in sequence
- Step 4: Turn on "Q1", "Q2", "Q3", "BAT" (BMS circuit breaker) in sequence
- Step 5: Turn on the "PV" (PV side circuit breaker)
- Step 6: Set the EMS working mode according to the application, and make the EMS work in automatic mode after setting.

After operating the steps one by one, check whether the indicator light of the product is on and whether the screen is displayed. If the product status is normal, the running indicator light is on, and the fault indicator light and alarm indicator light are off. The screen starts to display the system running status and parameters.

Product power off process

Operating procedures:

The process of powering off the main circuit is divided into 6 steps:

- Step 1: Stop the system through the screen or host computer
- Step 2: Disconnect "LOAD" (Load Side Breaker)
- Step 3: Disconnect "PV" (PV side breaker)
- Step 4: Disconnect "Q1", "Q2", "Q3", "BAT" in turn (BMS circuit breaker)
- Step 5: Disconnect "QF1" to "QF5" (each secondary circuit breaker) in sequence
- Step 6: Disconnect "GRID" (AC side breaker)

After operating step by step, the system will stop running, and the product indicators and screen will go out. After the inspection is completed, wait for five minutes to perform maintenance and inspection operations.

7 Human-Machine interface of HMI screen (optional)

Introduction to Operating System

The product is equipped with a 10-inch HMI screen. Users can choose an HMI screen, on which they can view the operating information of the system and set the operating parameters of the system. For the convenience of operation, the logical structure distribution diagram of the HMI screen menu is provided in the manual.

Note: If the user does not choose the HMI screen, the system can also run without affecting the system work.



Figure 7-1 HIMI Screen menu logical structure distribution diagram

There are six common function buttons on the left side of each interface: [Home] [Settings] [Control] [Data] [Warning] [Version]. Through these six common buttons, users can operate conveniently and quickly. On the left side of the interface, the sub-menu buttons corresponding to the above six commonly used buttons are displayed, and the selected buttons are marked in yellow.

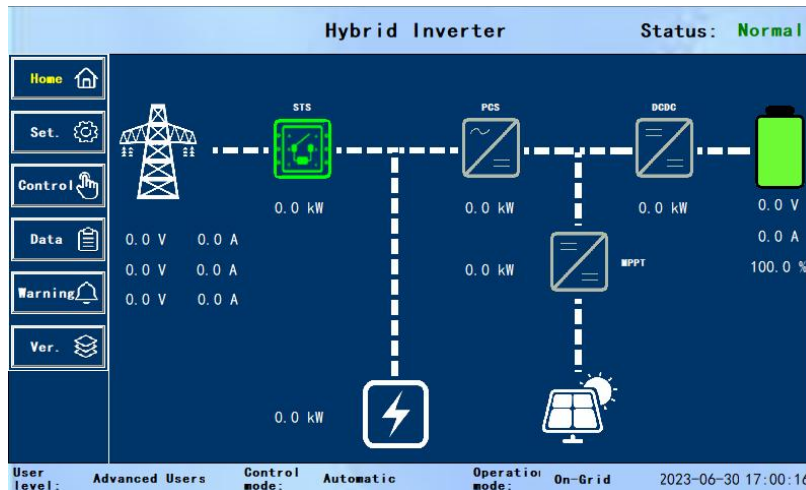

Figure 7-2 HMI screen main interface

Login Operation Guide

Table 7-1 Login operation guide

Step 1: Launch the login screen

After power-on, the touch screen will enter the initialization interface.

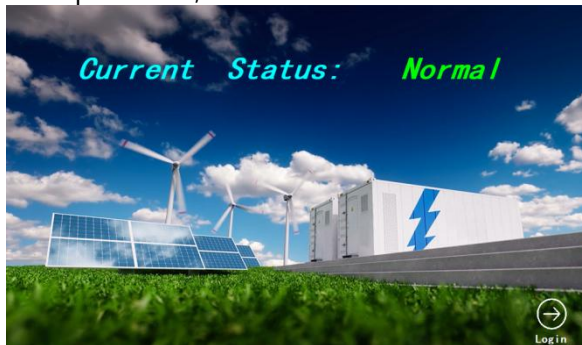

Step 2: Enter the initial login password

Click the [Login] button in the lower right corner to enter the login interface. The login level is divided into two categories: "General Users" and "Advanced Users", the "General Users" login password is 1234. "General User" can only perform operations on power on and off and browse parameter events, and "Advanced Users" has permission to modify parameters.

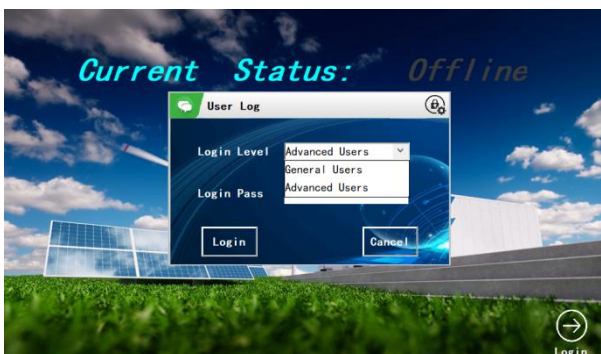

Step 3: Enter the login main interface

After logging in, the default "Home" is used. Click the [Home] button on the left side of any other interface to enter this interface.

In this interface, there are mainly grid three-phase status, STS power, load power, PCS

power, DCDC power, MPPT power, etc. Click the corresponding button to jump to the data interface, view the real-time data of each device and set the system.

Note: The factory staff or non-professionals, please do not set the system parameters, otherwise the equipment may not work, equipment may be damaged, or danger may occur.

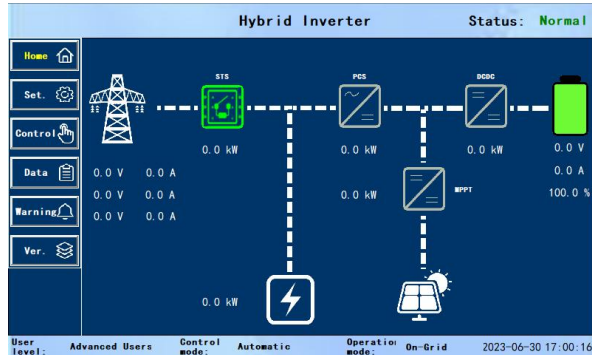

Step 4: Enter the setting interface

Note: General User does not have the Set permission.

Click the [Set.] button on the left of any other interface, the "User Log" interface appears, at this time, you can select the button options of [PCS], [DCDC], [EMS], [MPPT], [Parts], and select the device that needs to be viewed and set.

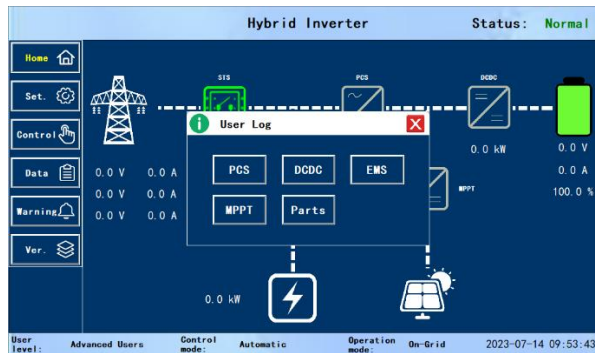

Step 5: Set parameters

Select [EMS] in the " User Log " of "Set.", enter the setting interface of EMS, display the "System Parameters" interface by default, click [Next] to enter other interfaces of system settings. Customers could configure "transformer capacity", "anti-reverse flow" and other items according to the actual application. Click the [Save] button in the lower left corner to permanently save the parameter settings until all interface parameters are set.

Except for EMS, other modules generally do not need to be set and use default parameters.

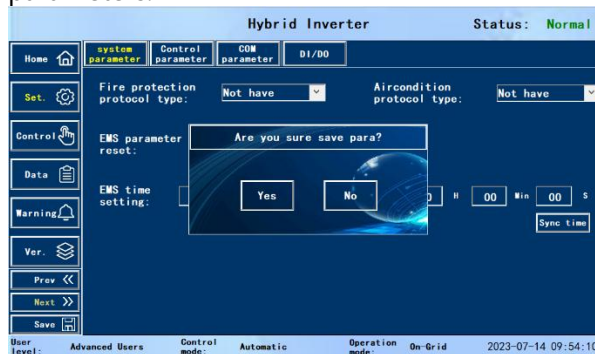

Step 6: Enter the control interface.

Click the [Control] button to enter the control menu, click the [EMS] button to enter the EMS control interface. By default, it enters the "Period Control" interface, where you can

define and select timed charging mode and SMS strategy. The timed charging mode can be selected as [Period/48 Segments]. The SMS strategy can be selected as [Timing Mode / Peak Shaving & Load Shifting / Spontaneous Self-use / Battery Priority].

Users can customize the power of the device within the time period from the start time to the end time, and flexibly set the operation strategy based on local electricity price policies and different needs.

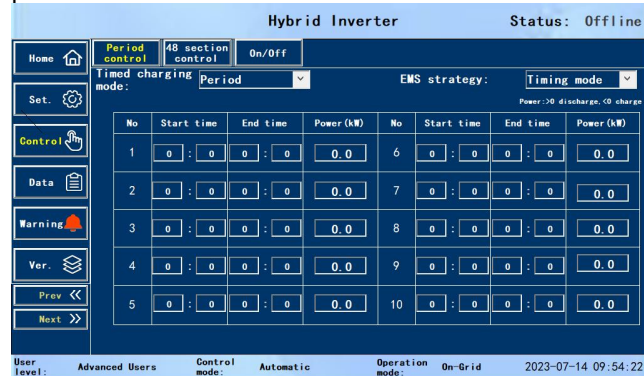

Step 7: Enter the setting interface again.

Finally, change the "Control Mode" to "Automatic" on this page and save it.

After completing the above settings, the system is in standby mode, at this time close the cabinet door and lock it. After the cabinet door is closed, the system will start to run. It can be found that the power light and the running light are on, and the fault light is off. Customers connected to the host computer can also view the system operation data through the host computer.

Fault description

If the troubleshooting provided by the fault description still does not solve the problem, please contact Dyness.

Table 7-2 Fault description

Symptoms	Processing method
Power light off	Check that each circuit breaker is closed
Running light off	Check that each circuit breaker is closed
Warning light on	Check whether there is any alarm through the screen or the web, whether it is caused by improper operation, if not, please contact the manufacturer for after-sales service
System abnormal sound	Check whether the air inlet and outlet of the air conditioner and fan are blocked or there are foreign objects. If the abnormal sound is inside the system, please contact the manufacturer for after-sales service.
Show access alarm	Check if the cabinet door is closed
Show flood alarm	Check whether the system is flooded, or whether the water sensor line is disconnected
Show emergency stop Alarm	Check if the emergency stop switch is released
Show SPD alarm	Check whether the lightning protector is damaged and whether the fault light is on. If it is damaged, please contact the after-sales service for replacement
Show gas detector alarm	Stop using it immediately and contact the manufacturer for after-sales service
Show temperature detector alarm	Stop using it immediately and contact the manufacturer for after-sales service
Show smoke detector alarm	Stop using it immediately and contact the manufacturer for after-sales service
Show other alarm	Need to contact the manufacturer for after-sales

8 System maintenance

The system needs to be maintained once a year, and the maintenance items are as follows:

Enclosure Inspection and cleanliness

Check the following items and correct them immediately if they do not meet the requirements:

- Check whether the outdoor cabinet and internal equipment are damaged or deformed.
- Check whether there is any abnormal noise during the operation of the internal equipment.
- Check whether the temperature inside the outdoor cabinet is too high.
- Check whether the humidity and grayscale inside the outdoor cabinet is within the normal range. Please Clean if necessary.
- Check whether the air inlet and outlet of the outdoor cabinet are blocked. If there is a blockage, please clean or replace the dust filter.

warning signs

Check whether the warning signs and labels are visible and not defaced. Replace if necessary.

Cable shield grounding

Check whether the cable shielding layer is in good contact with the insulating sleeve; whether the grounding copper bar is fixed in position.

Lightning protection devices and fuses

Check whether the lightning protection device and the fuse are well fastened.

Corrosion

Check whether there is oxidation or rust inside the outdoor cabinet.

System functions

Turn on and off to check if the system works abnormally.

9 Quality assurance

Warranty period: Refer to the quality assurance documents provided by various equipment manufacturers. For Dy Ness energy storage products that fail within the warranty period, we will be responsible for handling and providing appropriate replacement or repair solutions, providing free maintenance services or replacing new products. During the warranty period, we require customers to provide valid invoices and dates of purchased products as evidence. At the same time, the Dy Ness trademark on the product should be clearly visible to ensure the effectiveness of quality assurance.

We have the right not to provide quality assurance when the following situations occur:

- The complete machine or parts have exceeded the free warranty period.
- Improper installation, modification or use.
- Used under harsh environmental conditions beyond those specified in the product manual, or damaged due to abnormal natural environmental factors.
- Faults or damages caused by installation, maintenance, modification or disassembly by service agencies or individuals not authorized by Dy Ness.
- Fault or damage caused by using non-standard or non-authorized components or software.

For failures caused by the above situations, Dy Ness can provide paid maintenance services if required by customers.

If you have any questions about this product, please contact us. In order to solve your problem more conveniently and quickly, please provide the following information:

- Product model
- Purchase product serial number
- Fault description

10 Appendix

In order to better serve users, the company provides a list of check items, please check whether the following steps have been completed before the product runs.

No.	Check item	Yes/No
1	Check whether the appearance is damaged and whether the internal equipment is intact	<input type="checkbox"/>
2	Check whether the cabinet assembly is firm	<input type="checkbox"/>
3	Check whether the logo of the cabinet body and components is clear or damaged	<input type="checkbox"/>
4	Check whether the GRID wiring cables are connected in the correct sequence of AC cables	<input type="checkbox"/>
5	Check whether the LOAD wiring cables are connected according to the correct sequence of AC cables	<input type="checkbox"/>
6	Check whether the PV wiring cables are connected in the correct sequence of DC cables	<input type="checkbox"/>
7	Check whether the communication cable connection is complete	<input type="checkbox"/>
8	Check that the ground cable is faultless	<input type="checkbox"/>
9	Check if the meter reads correctly	<input type="checkbox"/>
10	Check that all connection points are connected correctly and have good contact	<input type="checkbox"/>
11	Check whether the manual operation parts are normal	<input type="checkbox"/>
12	Check whether the closing and opening of the circuit breaker are normal	<input type="checkbox"/>
13	Check whether the operation of relevant buttons and related indicators are normal	<input type="checkbox"/>
14	Check if the power light is normal	<input type="checkbox"/>
15	Check if the operation light is normal	<input type="checkbox"/>
16	Check whether the HMI screen is displayed normally and no error is reported	<input type="checkbox"/>
17	Check for lost tools and parts inside the equipment	<input type="checkbox"/>
18	Check whether the cabinet door is closed and opened flexibly	<input type="checkbox"/>



DISCOVER YOUR NATURE

Address: No. 511 Chenzhuang West Road, Sanshui Street,
Jiangyan District, Taizhou City

Email: service@dyness-tech.com

Tel: +86 400 666 0655

Web: www.dyness.com



Official Website



Digital version access