

User Manual

Energy Cube

In order to prevent improper operation before use, please carefully read this manual.

Table of Contents

1. Introduction.....	1
2. Symbols.....	1
3. Safety.....	2
3.1 Handling.....	2
3.2 Installation.....	2
4. Response to Emergency Situations.....	2
5. Product Information.....	3
5.1 CS Specifications.....	3
5.2 CM Specifications.....	3
5.3 Battery System Specifications for ECS2900.....	4
5.4 Battery System Specifications for ECS4100.....	5
6. Product Features.....	6
6.1 Battery System Features.....	6
7. Installation.....	7
7.1 Items in the package.....	7
7.2 Clearance.....	8
7.3 Tools.....	8
7.4 Installation Steps.....	9
7.5 Wiring Steps.....	12
7.6 System Start up.....	13
8. Commissioning.....	13
9. Exclusion.....	15
10. Troubleshooting and Maintenance.....	15
10.1 Maintenance.....	15
10.2 Troubleshooting.....	16

1. Introduction

The document describes the installation, commissioning, maintenance and troubleshooting of the following high voltage battery listed below.





ECS

Note: ECS = CM+CS

The battery chemistry of these products is Lithium Iron Phosphate. This manual is designed for qualified personnel only. The tasks described in this document should be performed by authorized and qualified technicians only.

After Installation the Installer must explain the user manual to the end user.

2. Symbols

	Caution, risk of electric shock.
	Do not place nor install near flammable or explosive materials.
	Install the product out of reach of children.
	Read the instruction manual before starting installation and operation.
	Do not dispose of the product with household wastes.
	Disconnect the equipment before carrying out maintenance or repair.
	Observe precautions for handling electrostatic discharge sensitive devices.
	Grounding conductor
	Caution, risk of electric shock, energy storage timed discharge.

3. Safety

Any work on the Batteries should be handled by authorized technicians and hence it is understood that the technicians should familiarize themselves with the contents of this manual before any maintenance or installation is carried out on the system.

3.1 Handling

- Do not expose battery to open flame.
- Do not place the product under direct sunlight.
- Do not place the product near flammable materials. It may lead to fire or explosion in case of accident.
- Store in a cool and dry place with ample ventilation.
- Do not store the product near water sources.
- Store the product on a flat surface.
- Store the product out of reach of children and animals.
- Do not damage the unit by dropping, deforming, impacting, cutting or penetrating with a sharp object. It may cause leakage of electrolyte or fire.
- Do not touch any liquid spilled from the product. There is a risk of electric shock or damage to skin.
- Always handle the battery wearing the insulated gloves.
- Do not step on the product or place any foreign objects on it. This can result in damage.
- Do not charge or discharge damaged battery.
- Do not store the battery near water sources.

3.2 Installation

- Do not connect the ECS to inverter conductors or Photo-Voltaic conductors. This will damage the battery and may result in explosion.
- After unpacking, please check the product for damages and missing parts.
- Make sure that the inverter and battery is completely turned off before commencing installation.
- Do not interchange the positive and negative terminals of the battery.
- Ensure that there is no short circuit of the terminals or with any external device.
- Do not exceed the battery voltage rating of the inverter.
- Do not connect the battery to any incompatible inverter.
- Do not connect different battery types together.
- Please ensure that all the batteries are grounded properly.
- Do not open the battery to repair or disassemble. Only Fox is allowed to carry out any such repairs.
- In case of fire, use only dry powder fire extinguisher. Liquid extinguishers should not be used.
- Install the batteries only inside approved Fox enclosure. Installing the battery anywhere outside is strictly forbidden.
- Do not install the battery near water sources or places where the battery can get wet.
- Install the battery away from children or pets.
- Do not use battery in high static environment where the protection device might be damaged.
- Do not install with other batteries or cells.

4. Response to Emergency Situations

The batteries comprise of multiple batteries connected in series. It is designed to prevent hazards or failures. However, Fox cannot guarantee their absolute safety.

Under exposure to the internal materials of the battery the following recommendations should be carried out by the user.

- If there has been inhalation, please leave the contaminated area immediately and seek medical attention.
- If there has been contact with eyes, rinse the eyes with running water for 15 minutes and seek medical attention immediately.
- If there has been contact with the skin, wash the contacted area with soap thoroughly and seek medical attention immediately.
- If there has been ingestion, induce vomiting and seek medical attention.

Fire Situation

In situations where the battery is on fire, if it is safe to do so, disconnect the battery pack by turning of the circuit breaker to shut off the power to the system. Use FM-200 or Co2 fire extinguisher for the battery and an ABC fire extinguisher for the other parts of the system.

Under any fire situation, please evacuate the people from the building immediately before trying to extinguish it.

Water Situation

The battery modules are not water resistant. Hence care should be taken not to get it wet. If you find the battery completely or partially submerged in water do not try to open. Contact an authorized personnel or Fox for further instructions.

5. Product Information

1. CS is the battery module, and CM includes system control module and battery module;
2. CM contains the controller of the entire system, so each system must have one CM;
3. Our system consists of at least 1 CS + 1 CM and up to 6 CS + 1 CM.







5.1 CS Specifications

Specifications for CS		
Model NO.	CS2900	CS4100
Max. charge/discharge current (A)	50	
Operating temperature (°C)	-10 ~ 55	
Storage temperature (°C)	-20 ~ 55	
Humidity	0 ~100%	
Normal voltage (V)	57.6	
Normal capacity (Ah)	50	70
Normal energy (kWh)	2.88	4.03
Battery voltage range [V]	48.6-65.7	
Max. Continuous discharge/charge current (A)	50/50	
(CC-CV) Standard charging current (A)	25	35
Constant current and voltage charging cut-off current (A)	2.5	3.5
Peak discharge current (60s)	65	
Dimensions (L*W*H) (mm)	570*380*155	
Weight (Kg)	32	35.6
Communication interfaces	RS485*2	

5.2 CM Specifications







Specifications for CM		
Model NO.	CM2900	CM4100
Max. charge/discharge current (A)	50	
Operating temperature (°C)	-10 ~ 55	
Storage temperature (°C)	-20 ~ 55	
Humidity	0 ~100%	
Normal voltage (V)	57.6	
Normal capacity (Ah)	50	70
Normal energy (kWh)	2.88	4.03
Battery voltage range [V]	48.6-65.7	
Max. Continuous discharge/charge current (A)	50/50	
(CC-CV) Standard charging current (A)	25	35
Constant current and voltage charging cut-off current (A)	2.5	3.5
Peak discharge current (60s)	65	
Dimensions (L*W*H) (mm)	570*380*170	
Weight (Kg)	34.9	38.5
Communication interfaces	RS485/CAN	

5.3 Battery System Specifications for ECS2900

Specifications for ECS2900						
Model No.	ECS2900-H2	ECS2900-H3	ECS2900-H4	ECS2900-H5	ECS2900-H6	ECS2900-H7
Technical Properties						
Battery designation*	IFpP42/151/108/[(18S)2S]E/-10+50/90	IFpP42/151/108/[(18S)3S]E/-10+50/90	IFpP42/151/108/[(18S)4S]E/-10+50/90	IFpP42/151/108/[(18S)5S]E/-10+50/90	IFpP42/151/108/[(18S)6S]E/-10+50/90	IFpP42/151/108/[(18S)7S]E/-10+50/90
The number of batteries	1CM+1CS	1CM+2CS	1CM+3CS	1CM+4CS	1CM+5CS	1CM+6CS
Normal voltage (V)	115.2	172.8	230.4	288	345.6	403.2
Normal capacity (Ah)	50	50	50	50	50	50
Normal energy (kWh)	5.76	8.64	11.52	14.4	17.28	20.16
Battery voltage range(V)	97.2-131.4	145.8-197.1	194.4-262.8	243-328.5	291.6-394.2	340.2-459.9
Max. charge/discharge current (A)	50/50					
(CC-CV) Standard charging current (A)	25					
Constant current and constant voltage charging cut-off current (A)	2.5					
Peak discharge Current (60s) (A)	65					
Storage temperature (°C)	-20°C ~55°C					
Operating Temperature range (°C)	Charge: 0°C ~55°C Discharge: -10°C ~55°C					
Discharge capacity (Ah)	0±2°C @1C @80% 25±2°C @1C @100% 45±2°C @1C @96%					
Cycle life	≥6000 @25°C @ 70%DOD					
Ingress protection	IP65					
Protective class	Class 1					
Demensions (L x W x H) (mm)	570*380*350	570*380*470	570*380*590	570*380*710	570*380*830	570*380*950
Weight (kg)	68.3	100.3	132.3	164.3	196.3	228.3
Communication interfaces	RS485/CAN					

Note: The battery designation is a series of numbers that represent the battery's positive and negative electrode types, structure and size, charge and discharge rate, and operating temperature range.

5.4 Battery System Specifications for ECS4100

Specifications for ECS4100						
Model No.	ECS4100-H2	ECS4100-H3	ECS4100-H4	ECS4100-H5	ECS4100-H6	ECS4100-H7
Technical Properties						
Battery designation*	IFpP42/151/108/[(18S)2S]E/-10+50/90	IFpP42/151/108/[(18S)3S]E/-10+50/90	IFpP42/151/108/[(18S)4S]E/-10+50/90	IFpP42/151/108/[(18S)5S]E/-10+50/90	IFpP42/151/108/[(18S)6S]E/-10+50/90	IFpP42/151/108/[(18S)7S]E/-10+50/90
The number of batteries	1CM+1CS	1CM+2CS	1CM+3CS	1CM+4CS	1CM+5CS	1CM+6CS
Normal voltage (V)	115.2	172.8	230.4	288	345.6	403.2
Normal capacity (Ah)	70	70	70	70	70	70
Normal energy (kWh)	8.06	12.09	16.12	20.15	24.18	28.21
Battery voltage range(V)	97.2-131.4	145.8-197.1	194.4-262.8	243-328.5	291.6-394.2	340.2-459.9
Max. charge/discharge current (A)	50/50					
(CC-CV) Standard charging current (A)	35					
Constant current and constant voltage charging cut-off current (A)	3.5					
Peak discharge Current (60s) (A)	65					
Storage temperature (°C)	-20°C ~55°C					
Operating Temperature range (°C)	Charge: 0°C ~55°C Discharge: -10°C ~55°C					
Discharge capacity (Ah)	0±2°C @1C @80% 25±2°C @1C @100% 45±2°C @1C @96%					
Cycle life	≥6000 @25°C @ 70%DOD					
Ingress protection	IP65					
Protective class	Class 1					
Demensions (L x W x H) (mm)	570*380*590	570*380*470	570*380*590	570*380*710	570*380*830	570*380*950
Weight (kg)	75.5	111.1	146.7	182.3	217.9	253.5
Communication interfaces	RS485/CAN					

Note: The battery designation is a series of numbers that represent the battery's positive and negative electrode types, structure and size, charge and discharge rate, and operating temperature range.

6. Product Features

6.1 Battery System Features

The batteries have been fitted with multiple protection systems to ensure the safe operation of the system. Some of the protection system includes:

- Inverter interface protection: Over voltage, Over current, External Short Circuit, Reverse Polarity, Ground Fault, Over Temp, In rush current
- Battery Protection: Internal Short Circuit, Over voltage, over current, over temp, Under voltage

The battery system contains the following Interface to allow it to connect and operate efficiently.

CS Features:

- interface:

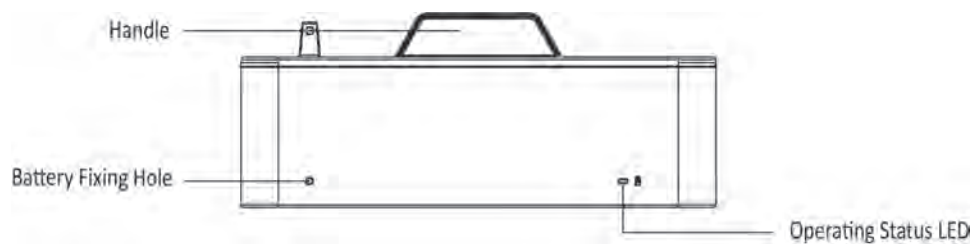

CM Features:

- interface

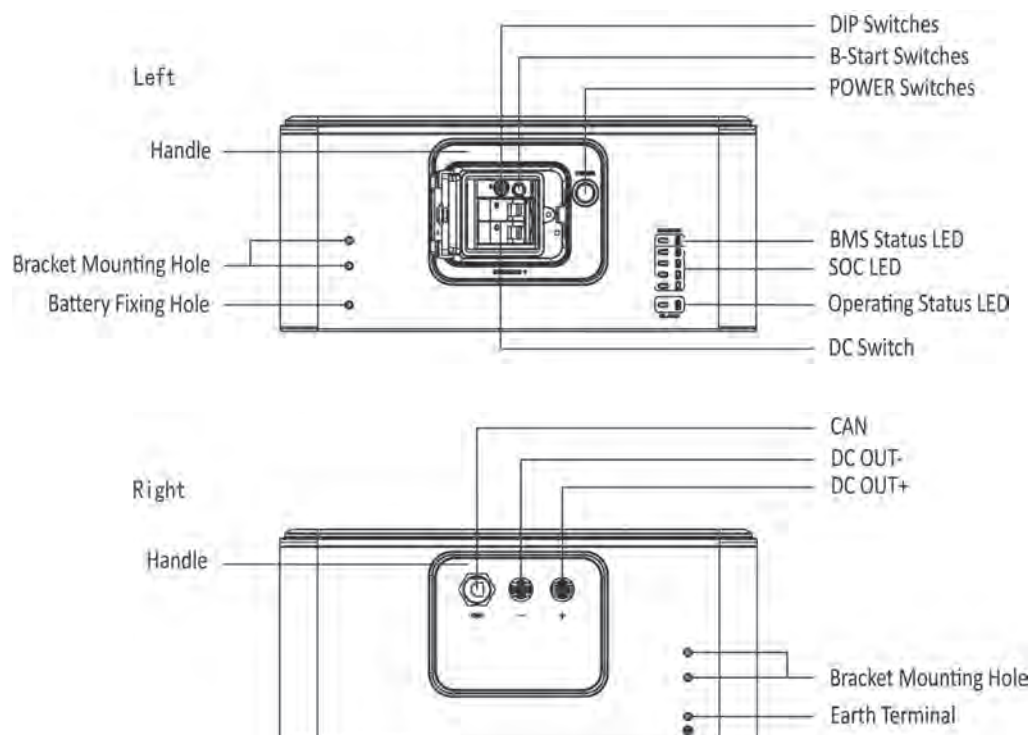

DC switch

Power switch, battery charge and discharge circuit switch.

DC OUT +

Connect bat + of inverter.

DC OUT -

Connect bat - of inverter.

POWER switches

System power on switch, press this switch, the system starts to work.

B-Start switches

Use this switch when there is no PV or grid access. And it needs to be used when the battery is discharged.

DIP switches

BMS relies on DIP switches to confirm the number of CS in the system.

BMS Status LED and SOC LED

LED display specific alarm information and battery system power.

Operating status LED

This LED is used to indicate if the battery is operating effectively. A green light on this LED means the battery is ON and operating normally. If the battery is operating failure, a red light on this LED means the battery is operating abnormally.

7. Installation

7.1 Items in the package

Please check if following items are including with the package:

For CS



A



B



No.	Items
A	Mounting screw pack
B	Installation guide & User manual

For CM



A



B



C



D



E



F



G



H



I

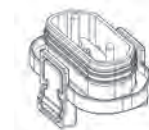

J

No.	Items	No.	Items
A	Mounting screw pack	F	DC positive output cable (1.2m)
B	Fixing bracket	G	DC negative output cable (1.2m)
C	Footstand	H	Installation guide & User manual
D	Communication cable (BMS-Inverter) (1.2m)	I	Expansion tube*2 & Expansion screw*2
E	Grounding cable (1.2m)	J	Waterproof cover

7.2 Clearance

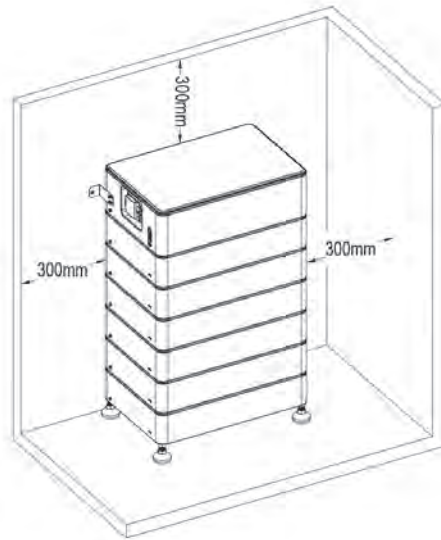

Make sure to leave a space of at least 300 mm. A clearance of at least 300 mm must be left around the battery pack for proper cooling.

Note: Make sure that the battery pack is always exposed to the ambient air. The battery pack is cooled by natural convection. If the battery pack is entirely or partially covered or shielded, it may cause the battery pack to stop operating.

7.3 Tools

The following tools will be required to install CM and CS.



Screw Driver



Crimping Modular



Safety Shoes



Multimeter



Safety Gloves



Safety Goggles



Plier



Ribbon



Electric Drill



Track Level Bar



Tape



Marker

7.4 Installation Steps

Step 1: Install a CS with four feetstand (Item C) and place it on the ground and adjust it to the level. After installing the feetstand, use a track level bar to confirm the level. Insert the waterproof cover (Item J) into the bottom of the battery and lock it in place with the clip.

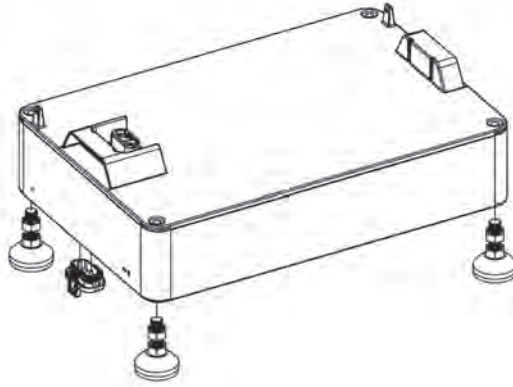

Step 2: Place the battery 20mm against the wall.

Note: Please make sure the Operating Status LED is on your left handside when you facing the battery model.

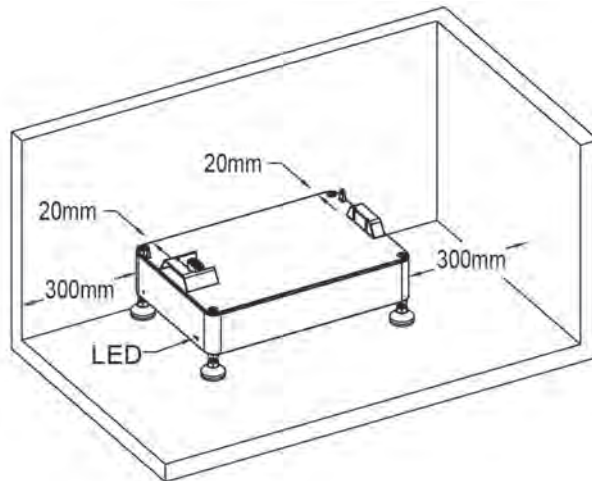

Step 3: Stack the batteries one by one.

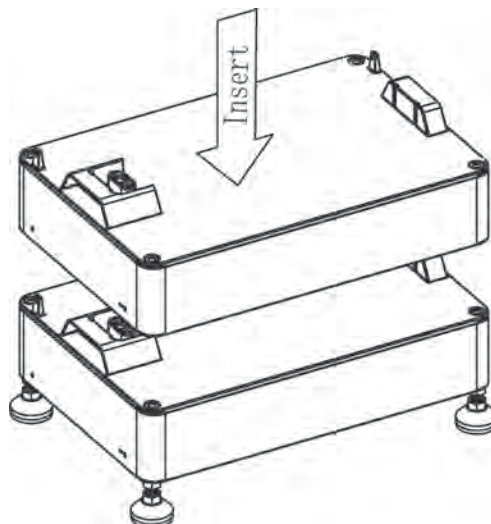

Step 4: Place the two fixing brackets (Item B) close to the wall and install them on both sides of the battery.

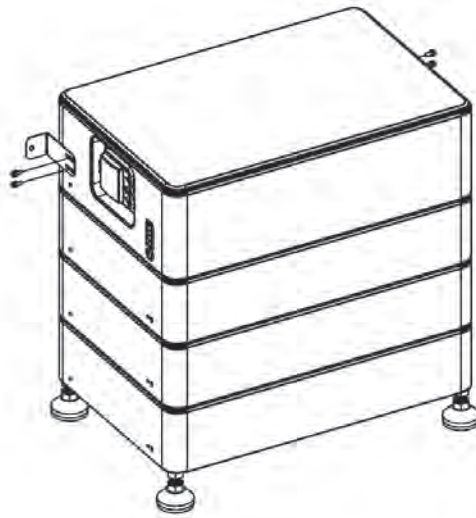

Step 5: Mark the wall through the bracket hole.

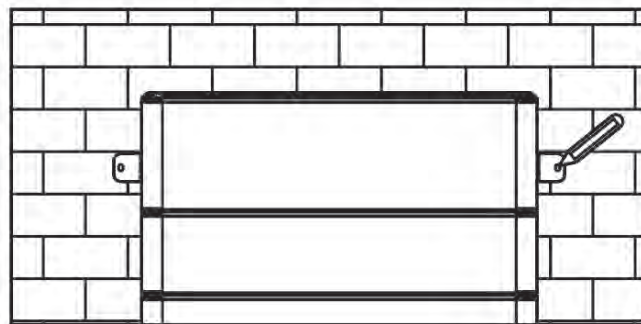

Step 6: Punch after removing the CM. Drill holes with electric drill, make sure the holes are at least 50mm deep, and then tighten the expansion tubes (Item I).

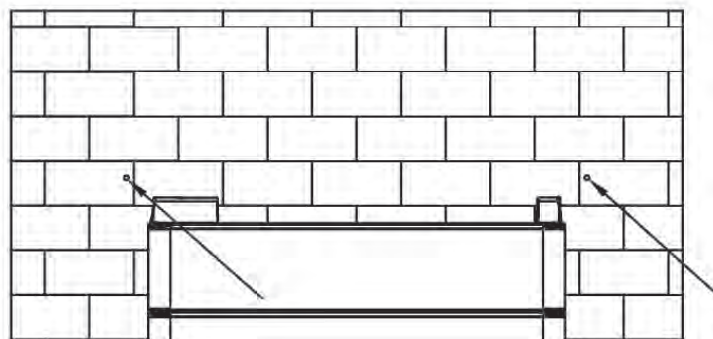

Step 7: After stacking CM again, fix the battery on the wall.

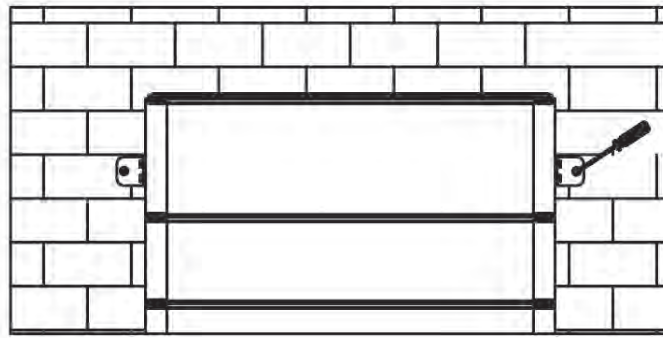

Step 8: Fix the mounting screw packs (Item A) on both sides of the battery, the installation is over.

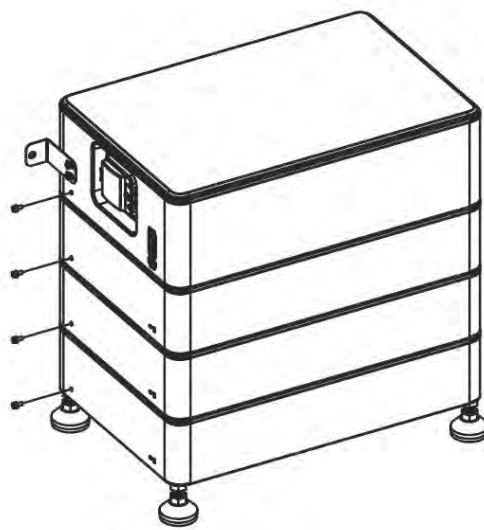

Note: Please make sure each system including 1 CM and 1 CS. CS less than 6 pieces:

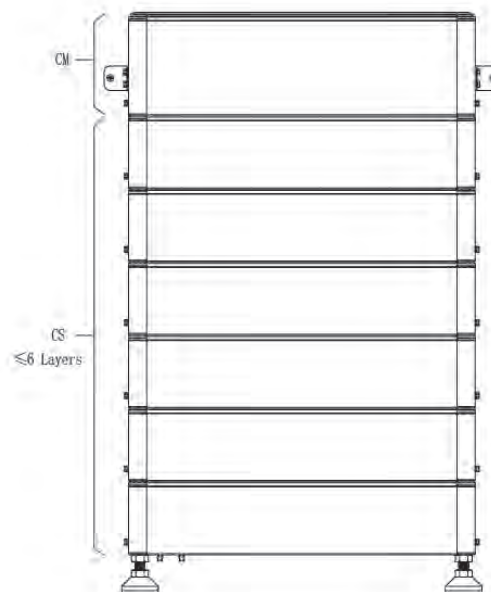

7.5 Wiring Steps

A: Connect the inverter to make sure the wiring position is correct, as shown in the figure below.
 Note: Inverter wiring refer to the inverter user manual.

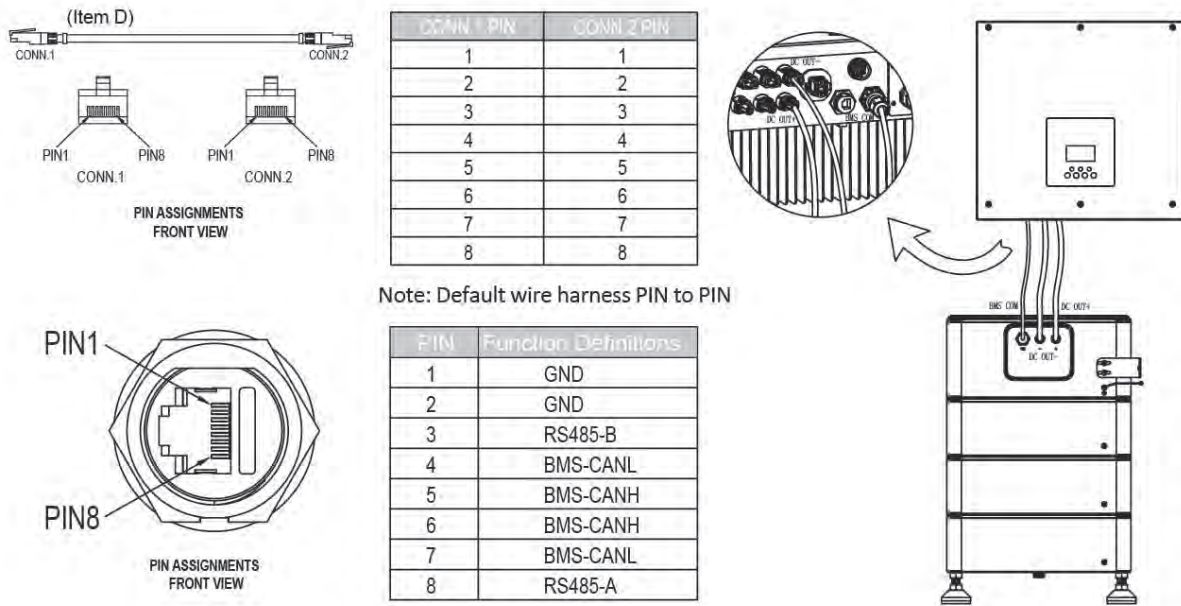

B: Connect the grounding cable to ensure that all batteries are grounded. Wiring shall be connected in the sequence as shown in below.

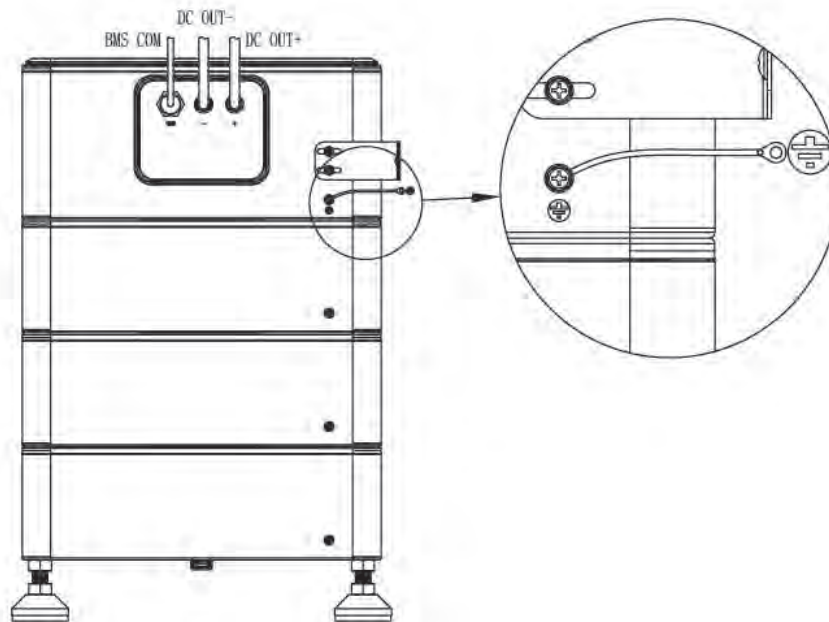

7.6 System Start up

- When the grid connected system is started, the inverter should be turned on first to avoid the current pulse of the inverter increasing to the battery pack.
- All installation and operation must comply with local electrical standards.
- Check all power cables and communication cables carefully.

1. Turn on the POWER switch

- Before starting, please dial DIP to the correct position. DIP represents the number of CS in the system. Please refer to the following table for details:

DIP position	The number of CS
0	1
1	2
2	3
3	4
4	5
5	6

- Normal mode: When there is PV and grid access, turn on DC switch first, then press "POWER" button.
- Black start: When there is no PV and grid access, turn on DC switch first, then press "POWER" button, then press and hold "B-Start" button and release it after 10s.
- Turn on DC switch and press the POWER switch. Alarm display and Alarm LED on CS/CM will light up at the same time for 1s to prove that the system is powered on successfully.

8. Commissioning

The operating status light on the left side of the battery pack shows its working status.





















Green LED	Red LED	Batteries Status
On for 1s	On for 1s	Initial power on
On for 4s	Off	Work
Off	On	Communication lost
On for 4s	On for 4s	Recoverable alarm
Off	On for 4s	Unrecoverable Alarm

For CM





- BMS Status LED

CM Condition	Green	Red
Error	Off	Flash
Standby	Flash	Off
Charge/Discharge (without warning)	On	Off
Charge/Discharge (warning)	Flash	Flash

- SOC LED indication

Status		Charge	Discharge	Stand By
=100%		On	On	Off
		On	On	
		On	On	
		On	On	
>100%>soc>=75%		Flash	On	
		On	On	
		On	On	
		On	On	
75%>soc>=50%		Off	Off	
		Flash	On	
		On	On	
		On	On	
50%>soc>=25%		Off	Off	
		Off	Off	
		Flash	On	
		On	On	
25%>soc>=0		Off	Off	
		Off	Off	
		Off	Off	
		Off	On	

- SOC LED fault message

Fault				
Differential pressure fault	Off	Off	Off	Flash
Under voltage fault	Off	Off	Flash	Off
Over temperature fault	Off	Off	Flash	Flash
Under temperature fault	Off	Flash	Off	Off
Discharge over current	Off	Flash	Off	Flash
Charge over current	Off	Flash	Flash	Off
Over voltage fault	Off	Flash	Flash	Flash
MCU fault	Flash	Off	Off	Off
AFE fault	Flash	Off	Off	Flash
Disconnection fault	Flash	Off	Flash	Off
Current sensor failure	Flash	Off	Flash	Flash
Insulation failure	Flash	Flash	Off	Off
Temperature sensor failure	Flash	Flash	Off	Flash
Contactors failure	Flash	Flash	Flash	Off
Slave control lost fault	Flash	Flash	Flash	Flash

9. Exclusion

The warranty shall not cover the defects caused by normal wear and tear, inadequate maintenance, handling, storage faulty repair, modifications to the battery or pack by a third party other than Fox or Fox agent, failure to observe the product specification provided herein or improper use or installation, including but not limited to the following.

- Damage during transport or storage.
- Incorrect Installation of battery into pack or maintenance.
- Use of battery pr pack in inappropriate environment.
- Improper, inadequate, or incorrect charge, discharge or production circuit other than stipulated herein.
- Incorrect use or inappropriate use.
- Insufficient ventilation.
- Ignoring applicable safety warnings and instructions.
- Altering or attempted repairs y unauthorized personnel.
- In case of force majeure (ex: lightning, storm, flood, fire, earthquake, etc.).
- There are no warranties-implied or express-other than those stipulated herein. Fox shall not be liable for any consequential or indirect damages arising or in connection with the product specification, battery or pack.

10. Troubleshooting and Maintenance

10.1 Maintenance

- A. Regularly check whether the service environment of the battery meets the requirements, and the installation position should be far away from the heat source.
- B. The battery module should be stored in an environment with a temperature range between -20°C-+55°C, and charged regularly according to the table below with no more than 0.5 C(A C-rate is a measure of the rate at which a battery is discharged relative to its maximum capacity.) to the SOC of 50% after a long time of storage.

Storage environment temperature	Relative humidity of the storage environment	Storage time	SOC
Below -20°C	/	Not allowed	/
-20~35°C	5%~70%	≤ 6 months	20%≤SOC≤60%
35~55°C	5%~70%	≤ 3 months	20%≤SOC≤60%
Above 55°C	/	Not allowed	/

NOTICE

Damage to the system due to under voltages

- Charge the over-discharged system within seven days when the temperature is above 25°C.
- Charge the over-discharged system within fifteen days when the temperature is below 25°C.

- C. Regularly check whether the battery and its supporting terminals, connecting cables and indicator lights are normal.

10.2 Troubleshooting

When the red / green LED on the panel is flashing or normally on, it does not mean that the CS is abnormal, it may be just an alarm or protection. Please check the 'LED status indicators' in chapter 7 for the detailed faulty definition before any trouble-shooting steps. In general, the alarm indication is normal without manual intervention. When the alarm triggering state is removed, CS will automatically return to normal use.

- Problem determination based on the following points

- 1) Whether the green light on the power switch is on;
- 2) Whether the buzzer in CM on;
- 3) Whether the battery system can be communicated with inverter;
- 4) Whether the battery can be output voltage or not.

- Preliminary determination steps

Battery system cannot work, when DC switch on and POWER on, the LED doesn't light up or flash, please consider contact the local distributor.

- 1) The LED display of CM and CS is normal, but it cannot charge and discharge. Observe the display screen of inverter and there is no SOC. Please check whether the CAN communication between CM to inverter is well connected. If the connection is good, please replace a CAN communication cable. If the SOC is still not visible on the inverter display screen, please contact the local distributor.
- 2) After the battery system is powered on, if you can see the alarm information on the LED and inverter display screen at the same time, please contact the local distributor.

The copyright of this manual belongs to FOXESS CO., LTD. Any corporation or individual should not plagiarize, partially or fully copy (including software, etc.), and no reproduction or distribution of it in any form or by any means is permitted. All rights reserved.

FOXESS CO., LTD

Add: Room A203, Building C, No.205 Binhai Six Road, New Airport Industry Area, Longwan District, Wenzhou City, Zhejiang Province, China.

Tel: 0510- 68092998

WWW.FOX-ESS.COM.