

Packing List

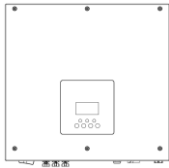

A



B

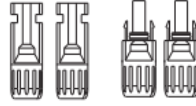

C



D



E

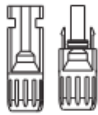

F



G

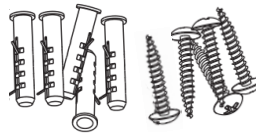

H



I



J



K

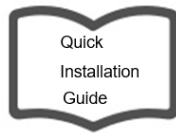

L



M



N



O



P

Object	Quantity	Description	Object	Quantity	Description
A	1	Inverter	I	1	Earth terminal
B	1	Bracket	J	1	Communication connector
C	4	PV connectors (for Hybrid only) (2*positive, 2*negative)	K	1	Product manual
D	4	PV pin contacts (for Hybrid only) (2*positive, 2*negative)	L	1	Quick installation guide
E	2	AC connectors	M	1	CT (with 10m cable)
F	2	Battery connectors (1*positive, 1*negative)	N	1	WiFi/LAN/GPRS (Optional)
G	2	Battery pin contacts (1*positive, 1*negative)	O	1	Meter (Optional)
H	5	Expansion tubes & Expansion screws	P	1	CT extension connector

Inverter Installation

Please make sure the inverter will be installed with a proper distance as shown below.

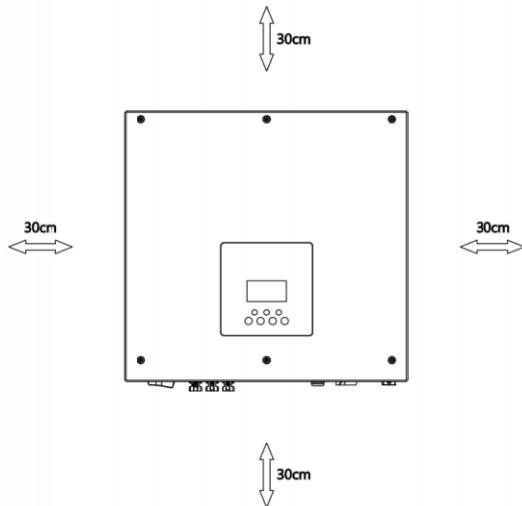

Position	Min Size
Left	30cm
Right	30cm
Top	30cm
Bottom	30cm
Front	30cm

Step 1: Fix the bracket on the wall

Choose the place you want to install the inverter. Place the bracket on the wall and mark the position of the 5 holes from bracket.

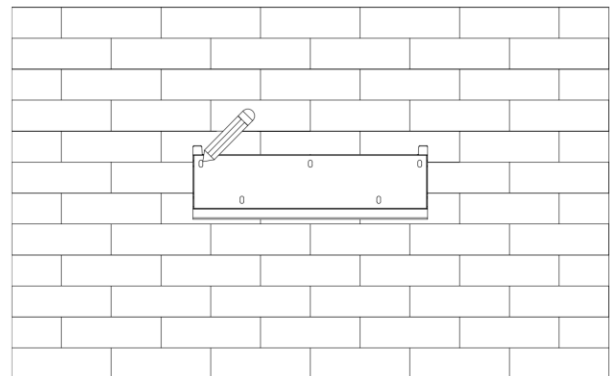

Drill holes with electric drill, make sure the holes are at least 50mm deep, and then tighten the expansion tubes.

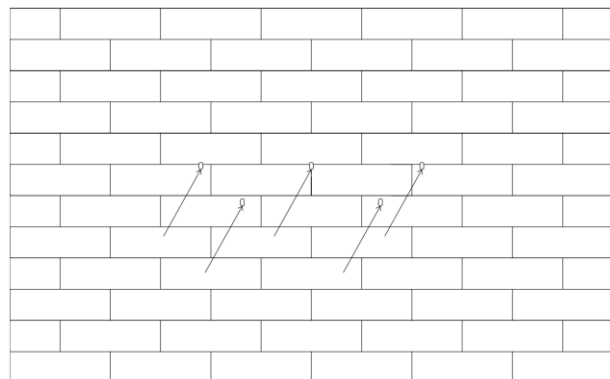

Insert the expansion tubes into the holes and tighten them. Install the bracket with the expansion screws.

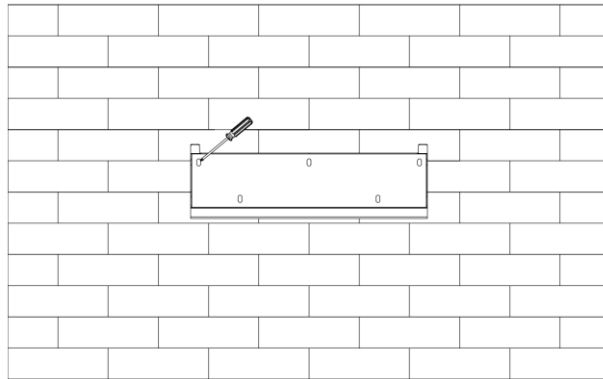

Step 2: Match the inverter with wall bracket

Hang the inverter over the bracket, slightly lower the inverter, and make sure the two mounting bars on the back are properly fixed with the two bracket grooves.

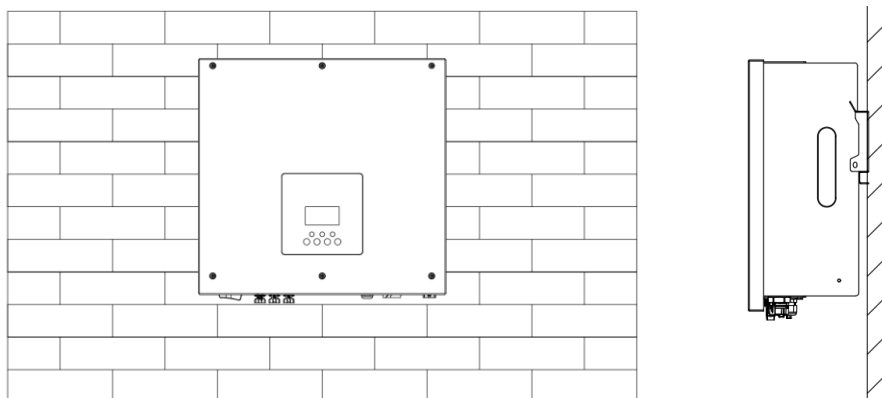

Serial Port Connections

Communication interface between the inverter and Meter/Battery/DRM/485 are as follows with RJ45 connectors which should be inserted corresponding port in the inverter.

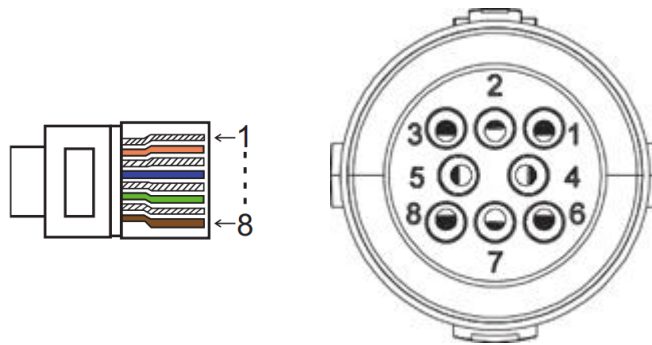

PIN Port	1	2	3	4	5	6	7	8
CT/ Meter/ 485	Meter 485A	Meter 485B	485B	485A	CT2+	CT2-	CT1-	CT1+
BMS	/	GND	BMS- 485B	BMS- CANL	BMS- CANH	/	/	BMS- 485A
DRM	GND	GND	DRM0	+3.3V	DRM 4/8	DRM 3/7	DRM 2/6	DRM 1/5

Note:

CT1: For Hybrid/AC, CT2: Grid tied inverter (if have).

Compatible Meter type: DDSU666 (CHINT), SDM230 (EASTRON).

Wiring Steps

PV Wiring (For Hybrid Only)

- Choose 12 AWG wire to connect the PV module.
- Trim 6mm of insulation from the wire end.

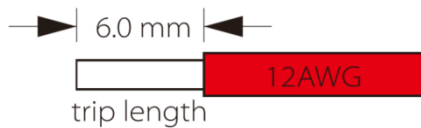

- Separate the DC connector (PV) as below.

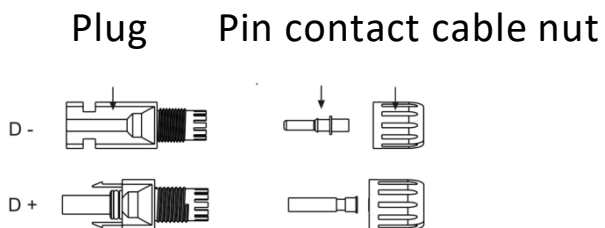

- Insert striped cable into pin contact and ensure all conductor strands are captured in the pin contact.
- Crimp pin contact by using a crimping plier. Put the pin contact with striped cable into the corresponding crimping pliers and crimp the contact.

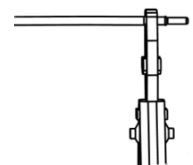

- Insert pin contact through the cable nut to assemble into back of the male or female plug. When you feel or hear a “click” the pin contact assembly is seated correctly.

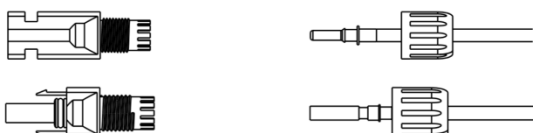

- Unlock the DC connector:
 - Use the specified wrench tool.
 - When separating the DC+ connector, push the tool down from the top.
 - When separating the DC- connector, push the tool down from the bottom.
 - Separate the connectors by hand.

Battery Wring

- Turn off the DC switch.
- Choose 10 AWG wire to connect the battery.
- Trim 6mm of insulation from the wire end.

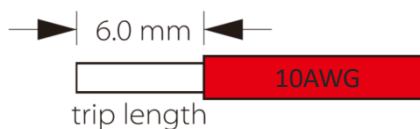

- Separate the DC connector (battery) as below.

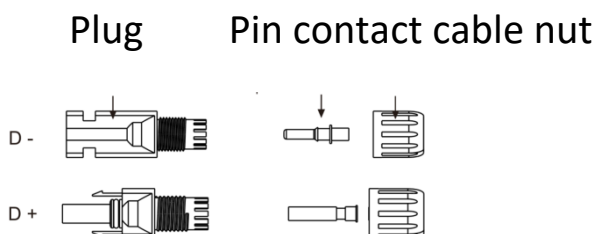

- Insert striped cable into pin contact and ensure all conductor strands are captured in the pin contact.

- Crimp pin contact by using a crimping plier. Put the pin contact with striped cable into the corresponding crimping pliers and crimp the contact.

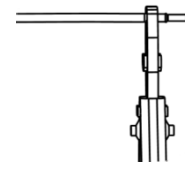

- Insert pin contact through the cable nut to assemble into back of the male or female plug. When you feel or hear a “click” the pin contact assembly is seated correctly.



- Unlock the DC connector
 - Use the specified wrench tool.
 - When separating the DC + connector, push the tool down from the top.
 - When separating the DC - connector, push the tool down from the bottom.
 - Separate the connectors by hand.

Grid Wiring

Cable dimensions

Model (kW)	3.0	3.7	4.6	5.0	6.0
Cable (AC)	8.0mm ²	8.0mm ²	8.0mm ²	8.0mm ²	10.0mm ²
Cable (BACK-UP)	4.0mm ²	4.0mm ²	6.0mm ²	6.0mm ²	6.0mm ²
Micro-Breaker	50A	50A	63A	63A	63A

- Trim all the wires to 52.5mm and the PE wire to 55mm.
- Use the crimping pliers to trim 12mm of insulation from all wire ends as shown in the picture.

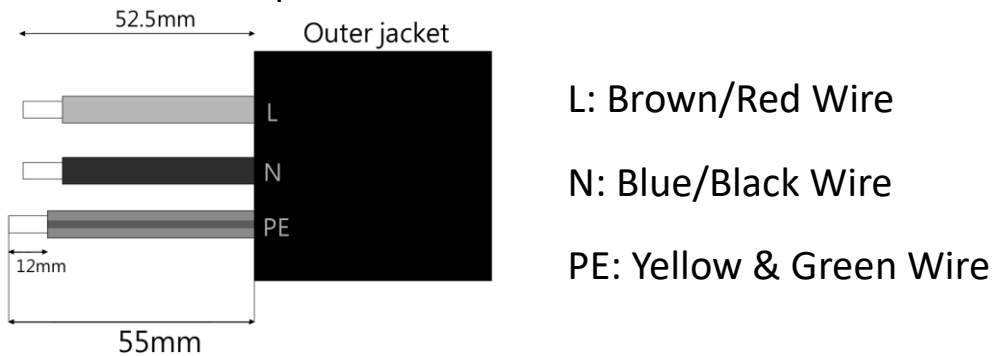

Note: Please refer to local cable type and color for actual installation.

A. BACK-UP Wiring

- Separate the BACK-UP plug into three parts as below.
 1. Hold the middle part of the female insert, rotate the back shell to loosen it, and detach it from female inset.
 2. Remove the cable nut (with rubber insert) from the back shell.

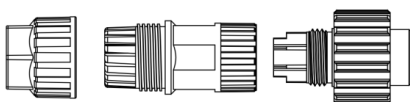

- Slide the cable nut and then the back shell onto the cable.

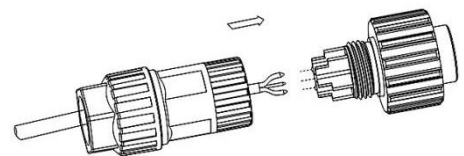

- Push the threaded sleeve into the socket, tighten up the cap on the terminal.

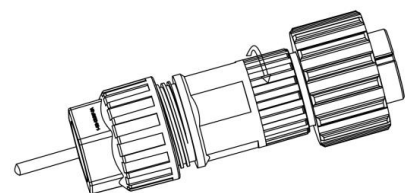

- Push the threaded sleeve to connection terminal until both are locked tightly on the inverter.

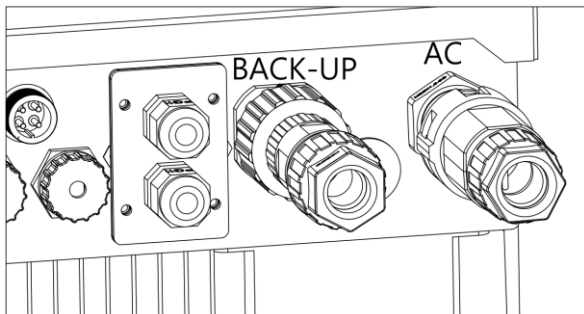

- Loosen the cap on the terminal, pull the threaded sleeve out of the socket.

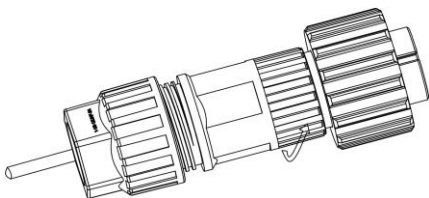

B. AC Wiring

- Separate the AC plug into three parts as below.
 1. Hold the middle part of the female insert, rotate the back shell to loosen it, and detach it from female inset.
 2. Remove the cable nut (with rubber insert) from the back shell.



- Slide the cable nut and then the back shell onto the cable.

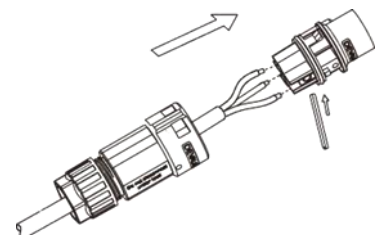

- Push the threaded sleeve into the socket, tighten up the cap on the terminal.

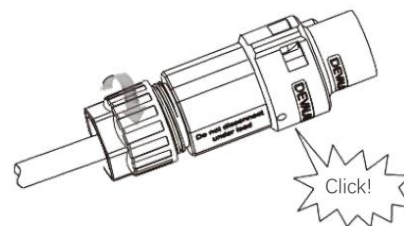

- Push the threaded sleeve to connection terminal until both are locked tightly on the inverter.

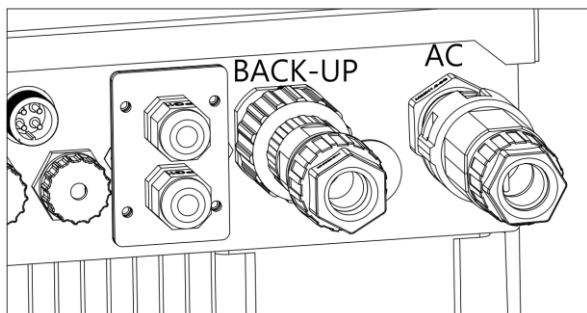

- Remove the AC connector: Press the bayonet out of the slot with a small screwdriver or the unlock tool and pull it out, or unscrew the threaded sleeve, then pull it out.

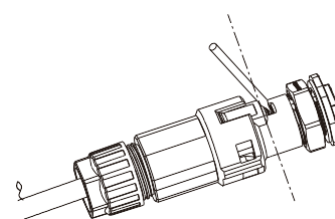

Grounding Wiring

Use the crimping pliers to press the ground cable into the ground terminal, screw the ground screw with screwdriver as shown below.

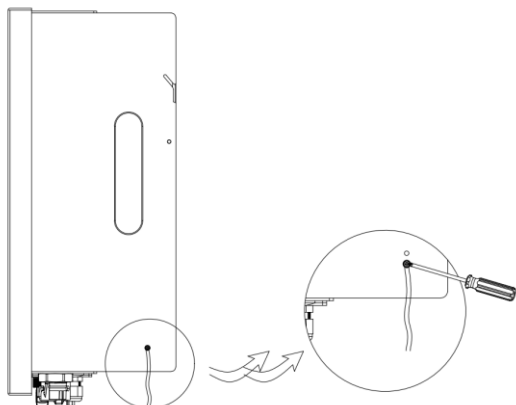

BMS Connection

Step 1: Prepare a standard network cable and cable connector, then insert the network cable through the cable connector.

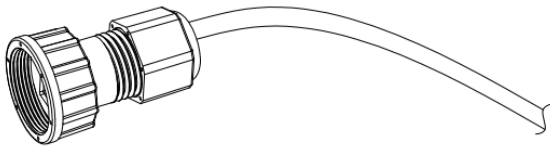

Step 2: Crimp the cable with a Rj45 plug which is inside of the cable connector.

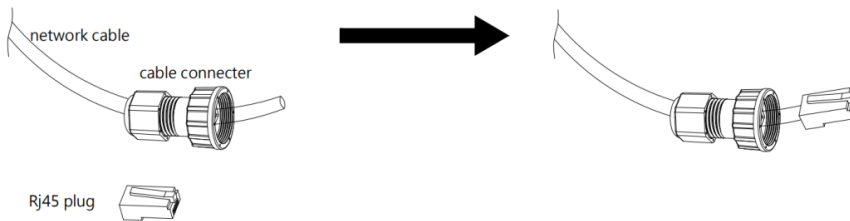

Step 3: Insert the cable connector into BMS port at the bottom of inverter.

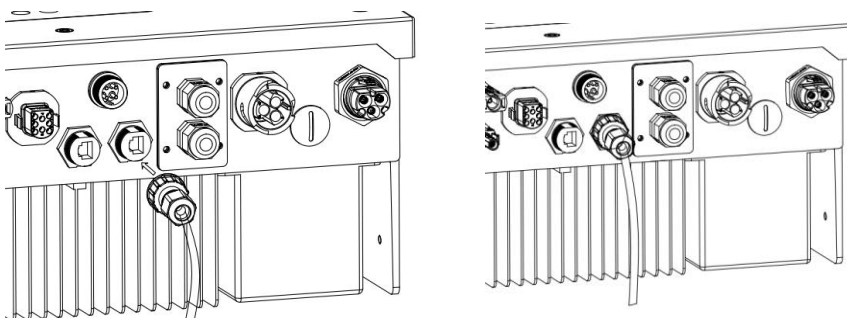

Inverter Start-Up

Please refer to the following steps to start up the inverter.

1. Ensure the inverter fixed well on the wall.
2. Make sure all the AC wirings are completed.
3. Make sure the meter is connected well.
4. Make sure the battery is connected well.
5. Make sure the external EPS contactor is connected well (if needed).
6. Turn on the PV/DC switch (for Hybrid only), AC breaker, EPS breaker and battery breaker.
7. Enter the settings page, select START / STOP and set it to start.

Note:

- When starting the inverter for the first time, the country code will be set by default to the local settings. Check if the country code is correct.
- Set the time on the inverter using the button or by using the APP.

Inverter Switch Off

Please refer to the following steps to switch off the inverter.

1. Enter the settings page, select START / STOP and set it to stop.
2. Turn off the PV/DC switch (for Hybrid only), AC breaker, EPS breaker and battery breaker.
3. Wait 5 min before you open the upper lid (if in need of repair).