



Installation Guide

StorEdge Three Phase Inverter

with SetApp Configuration

For Europe and APAC

Version 1.1

Disclaimers

Important Notice

Copyright © SolarEdge Inc. All rights reserved.

No part of this document may be reproduced, stored in a retrieval system or transmitted, in any form or by any means, electronic, mechanical, photographic, magnetic or otherwise, without the prior written permission of SolarEdge Inc.

The material furnished in this document is believed to be accurate and reliable. However, SolarEdge assumes no responsibility for the use of this material. SolarEdge reserves the right to make changes to the material at any time and without notice. You may refer to the SolarEdge web site (www.solaredge.com) for the most updated version.

All company and brand products and service names are trademarks or registered trademarks of their respective holders.

Patent marking notice: see <http://www.solaredge.com/patent>

The general terms and conditions of delivery of SolarEdge shall apply.

The content of these documents is continually reviewed and amended, where necessary. However, discrepancies cannot be excluded. No guarantee is made for the completeness of these documents.



The images contained in this document are for illustrative purposes only and may vary depending on product models.

Emission Compliance

This equipment has been tested and found to comply with the limits applied by the local regulations.

These limits are designed to provide reasonable protection against harmful interference in a residential installation. This equipment generates, uses and can radiate radio frequency energy and, if not installed and used in accordance with the instructions, may cause harmful interference to radio communications. However, there is no guarantee that interference will not occur in a particular installation. If this equipment does cause harmful interference to radio or television reception, which can be determined by turning the equipment off and on, you are encouraged to try to correct the interference by one or more of the following measures:

- Reorient or relocate the receiving antenna.
- Increase the separation between the equipment and the receiver.

-  Connect the equipment into an outlet on a circuit different from that to which the receiver is connected.
-  Consult the dealer or an experienced radio/TV technician for help.

Changes or modifications not expressly approved by the party responsible for compliance may void the user's authority to operate the equipment.

Contents

Disclaimers	1
Important Notice	1
Emission Compliance	1
Revision History	5
HANDLING AND SAFETY INSTRUCTIONS	6
Safety Symbols Information	6
IMPORTANT SAFETY INSTRUCTIONS	6
Chapter 1: Overview	10
The StorEdge Solution Components	10
Installation Equipment List	11
Inverter Transport and Storage	12
Chapter 2: Installing the Power Optimisers	13
Safety	13
Installation Guidelines	14
Step 1: Mounting the Power Optimisers	16
Step 2: Connecting a PV Module to a Power Optimizer	16
Step 3: Connecting Power Optimisers in Strings	17
Step 4: Verifying Proper Power Optimiser Connection	18
Chapter 3: Installing the Inverter	19
Inverter Package Contents	19
Identifying the Inverter	19
Inverter Interfaces	20
Mounting the Inverter	24
Selecting a Residual Current Device (RCD)	26
Chapter 4: Installing the Battery	28
Chapter 5: Connecting the Inverter	29
Connecting the AC Grid	29
Connecting the Strings to the Inverter	30
Connecting the Energy Meter	31
Connecting the Battery	33
Chapter 6: Activating, Commissioning and Configuring the System	37
Step 1: Activating the Installation	37
Step 2: Commissioning and Configuring the Installation	38
Step 3: Verifying Proper Activation and Commissioning	42
Configuring Communication with the Energy Meter	42
Configuring Communication with the Battery	43
Running a Battery Self-test	43

Configuring StorEdge Applications	44
Viewing System Status	44
Chapter 7: Setting Up Communication to the Monitoring Platform	52
Communication Options	52
Verifying the Connection	53
Reporting and Monitoring Installation Data	54
Appendix A: Errors and Troubleshooting	57
Identifying Errors	57
Troubleshooting Communication	58
StorEdge Three Phase Inverter Troubleshooting	59
Power Optimiser Troubleshooting	60
Appendix B: Mechanical Specifications	62
Appendix C: SafeDC™	63
StorEdge Three Phase Inverter - Technical Specifications	64
Support Contact Information	67

Revision History

Version 1.1 (November 2019)

-  Editorial changes

Version 1.0 (August 2019)

-  First version of this guide

HANDLING AND SAFETY INSTRUCTIONS

During installation, testing and inspection, adherence to all the handling and safety instructions is mandatory. **Failure to do so may result in injury or loss of life and damage to the equipment.**

Safety Symbols Information

The following safety symbols are used in this document. Familiarize yourself with the symbols and their meaning before installing or operating the system.

WARNING!



Denotes a hazard. It calls attention to a procedure that, if not correctly performed or adhered to, could result in **injury or loss of life**. Do not proceed beyond a warning note until the indicated conditions are fully understood and met.

CAUTION!



Denotes a hazard. It calls attention to a procedure that, if not correctly performed or adhered to, could result in **damage or destruction of the product**. Do not proceed beyond a caution sign until the indicated conditions are fully understood and met.

NOTE



Denotes additional information about the current subject.

IMPORTANT SAFETY FEATURE



Denotes information about safety issues.

Disposal requirements under the Waste Electrical and Electronic Equipment (WEEE) regulations:

NOTE



Discard this product according to local regulations or send it back to SolarEdge.

IMPORTANT SAFETY INSTRUCTIONS

SAVE THESE INSTRUCTIONS

WARNING!



The inverter cover must be opened only after shutting off the inverter P/ON/OFF switch located at the bottom on the inverter. This disables the DC voltage inside the inverter. Wait five minutes before opening the cover. Otherwise, there is a risk of electric shock from energy stored in the capacitors.



P = Program/Pair
1 = ON
0 = OFF

WARNING!

Before operating the inverter, ensure that the inverter AC power cable and wall outlet are grounded properly. This product must be connected to a grounded, metal, permanent wiring system, or an equipment-grounding conductor must be run with the circuit conductors and connected to the equipment grounding terminal or lead on the product.

WARNING!

Opening the inverter and repairing or testing under power must be performed only by qualified service personnel familiar with this inverter.

WARNING!

Do not touch the PV panels or any rail system connected when the inverter switch is ON, unless grounded.

WARNING!

SafeDC complies with IEC60947-3 when installing the system with a worst case SafeDC voltage (under fault conditions) < 120V.

The worst case voltage is defined as: $V_{oc,max} + (\text{String Length} - 1) * 1V$, where:

- $V_{oc,max}$ = Maximum V_{oc} (at lowest temperature) of the PV models in the string (for a string with multiple models, use the max value)
- String Length = number of power optimizers in the string

CAUTION!

This unit must be operated according to the technical specification datasheet provided with the unit.

CAUTION!

HEAVY OBJECT. To avoid muscle strain or back injury, use proper lifting techniques, and if required - a lifting aid.

NOTE

The inverter is IP65 rated . Unused conduit openings and glands should be sealed with appropriate seals.

**NOTE**

Use PV models rated according to IEC 61730 class A.

**NOTE**

The symbol  appears at grounding points on the SolarEdge equipment. This symbol is also used in this manual.

NOTE

A SolarEdge inverter may be installed in a site with a generator. SolarEdge requires installing a physical or electronic interlock, which will signal to the inverter when the grid has been disconnected. Interlock procurement, installation, maintenance and support are the responsibility of the installer.



Damage to the inverter due to incorrect interlock installation or use of an interlock that is incompatible with the SolarEdge system will render the SolarEdge warranty invalid.

For more information, refer to

<https://www.solaredge.com/sites/default/files/se-inverter-support-of-voltage-sources.pdf>.

**NOTE**

The following warning symbols appear on the inverter warning label:



Risk of electric shock



Risk of electric shock from energy stored in the capacitor. Do not remove cover until 5 minutes after disconnecting all sources of supply.



Hot surface – To reduce the risk of burns, do not touch.

**WARNING!**

Before operating the system, ensure that the been grounded properly.

**WARNING!**

When handling the battery, adhere to all manufacturer safety instructions.

**CAUTION!**

This unit must be operated under the specified operating conditions as described in the technical specifications supplied with the unit.



NOTE

The battery used with the inverter must conform to all local certification requirements.



NOTE

For battery decommissioning and disposal, follow the manufacturer requirements and instructions.

Chapter 1: Overview

SolarEdge's StorEdge™ solution for Smart Energy Management, enables connecting a battery to the inverter.

Power is stored in the battery and can be used for various applications such as maximized self-consumption and time of use profile programming. For backup power, an inverter specifically designed for backup applications is required; this inverter is not in the scope of this document.

The StorEdge Solution Components

- **StorEdge Inverter** is connected to a battery and supplies control and monitoring signals to the battery for operation, in addition to its traditional functionality as a DC-optimized PV inverter.
- **Energy Meter** - The meter is used by the inverter for export/ consumption readings, and for Smart Energy Management applications, such as: export limitation, and maximizing self-consumption.
- **Battery** - A 48V battery designed to work with the StorEdge system. Make sure to use SolarEdge-approved batteries only.

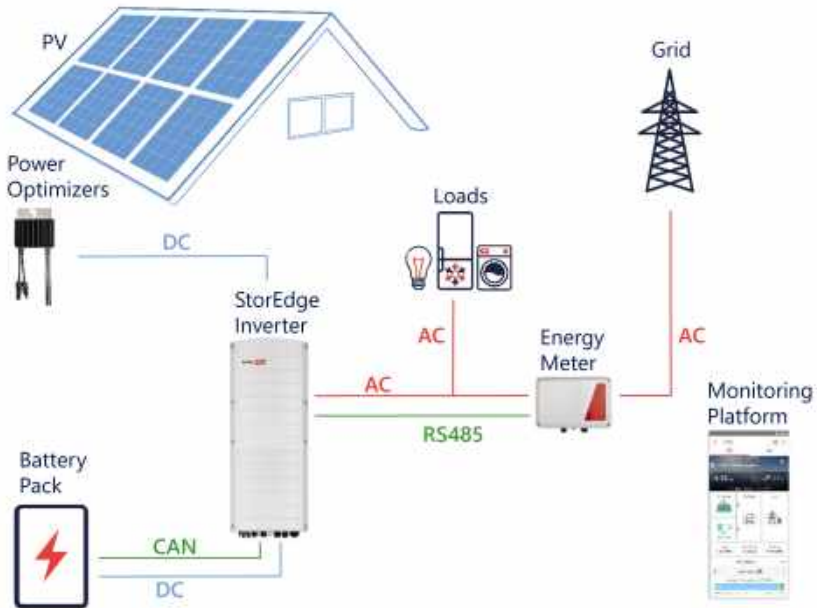

Figure 1: StorEdge system components

NOTE



- Additional SolarEdge inverters (without batteries) can be connected with RS485. The inverters will participate in export limitation and Smart Energy Management.
- PV modules connected to power optimizers are not mandatory for charge/discharge profile programming.

Installation Equipment List

Standard tools can be used during the installation of the SolarEdge system. The following is a recommendation of the equipment needed for installation:

- Allen screwdriver for 5mm screw type for the inverter cover and inverter side screws
- Allen screwdriver for M5/M6/M8 screw types
- Safety gloves
- Standard flat-head screwdrivers set
- Non-contact voltage detector
- Cordless drill (with a torque clutch) or screwdriver and bits suitable for the surface on which the inverter and optimizers will be installed. Use of an impact driver is *not* allowed
- Appropriate mounting hardware (for example: stainless bolts, nuts, and washers) for attaching:
 - the mounting bracket to the mounting surface
 - the power optimizer to the racking (not required for smart modules)
- Wire cutters
- Wire strippers
- Voltmeter

For installing the communication options, make sure you have the following:

- For Ethernet:
 - CAT5/6 twisted pair Ethernet cable with RJ45 connector
 - If using a CAT5/6 cable spool: RJ45 connector and RJ45 crimper
- For RS485:
 - Four- or six-wire shielded twisted pair cable.
 - Watchmaker precision screwdriver set

- For CAN
 - Six-wire shielded twisted pair cable with RJ45 connector
 - CAT5/6 twisted pair Ethernet cable with RJ45 connector

For connecting the battery to the inverter, use copper cables with the following parameters:

- Maximum length: 5m
- Cross-section area: 35 or 50 mm²
- Crimping tools
- Shrinking tools

Inverter Transport and Storage

Transport the inverter in its original packaging, facing up and without exposing it to unnecessary shocks. If the original package is no longer available, use a similar box that can withstand the weight of the inverter (refer to the inverter weight in the specification datasheet provided with the unit), has a handle system and can be closed fully.

Store the inverter in a dry place where ambient temperatures are -25°C to +65°C / -13°F to 149°F.

Chapter 2: Installing the Power Optimisers

Safety

WARNING!

When modifying an existing installation, turn OFF the inverter ON/OFF/P switch, the Connection Unit (if applicable) and the AC circuit breaker on the main AC distribution panel.

CAUTION!

Power optimizers are IP68/NEMA6P rated. Choose a mounting location where optimizers will not be submerged in water.

CAUTION!

This unit must be operated according to the operating specifications provided with the unit.

CAUTION!

Cutting the power optimizer input or output cable connector is prohibited and will void the warranty.

CAUTION!

All PV models must be connected to a power optimizer.

CAUTION!

If you intend to mount the optimizers directly to the model or model frame, first consult the model manufacturer for guidance regarding the mounting location and the impact, if any, on model warranty. Drilling holes in the model frame should be done according to the model manufacturer instructions.

CAUTION!

Installing a SolarEdge system without ensuring compatibility of the model connectors with the optimizer connectors may be unsafe and could cause functionality problems such as ground faults, resulting in inverter shut down. To ensure mechanical compatibility of the power optimizers' connectors with the PV model' connectors to which they are connected:

- Use identical connectors from the same manufacturer and of the same type on both the power optimizers and on the models; or
- Verify that the connectors are compatible in the following way:
 - The model connector manufacturer should explicitly verify compatibility with the SolarEdge optimizer connector; and
 - A third-party test report by one of the listed external labs (TUV, VDE, Bureau Veritas UL, CSA, InterTek) should be obtained, verifying the compatibility of the connectors.

For more information, refer to

<https://www.solaredge.com/sites/default/files/optimizer-input-connector-compatibility.pdf>



Installation Guidelines

- The minimum and maximum string length guidelines are stated in the power optimizer datasheets. Refer to the Designer for string length verification. The Designer is available on the SolarEdge website at <https://www.solaredge.com/products/installer-tools/designer#/>.

- Frame-mounted power optimizers are mounted directly on the module frame, regardless of racking system (rail-less or with rails). For installation of frame-mounted power optimizers, refer to http://www.solaredge.com/sites/default/files/installing_frame_mounted_power_optimizers.pdf.



- The power optimizer can be placed in any orientation.
- If connecting more modules than optimizer inputs in parallel, use a branch cable. Some commercial power optimizer models have a dual input.

- Position the power optimizer close enough to its module so that their cables can be connected.
- Make sure to use power optimizers that have the required output conductor length:
 - *Do not* use extension cables between a module and a power optimizer, between two modules connected to the same optimizer, or between two optimizers other than in the cases specified below.
 - You can use extension cables between power optimizers only from row to row, around obstacles or pathways within a row, and from the end of the string to the inverter, as long as the maximum distance is not exceeded.
- Completely shaded modules may cause their power optimizers to temporarily shut down. This will not affect the performance of the other power optimizers in the string, as long as the minimum number of unshaded power optimizers connected in a string of modules is met. If under typical conditions fewer than the minimum optimizers are connected to unshaded modules, add more optimizers to the string.
- To allow for heat dissipation, maintain a minimum of 2.5 cm / 1" clearance between the power optimizer and other surfaces, on all sides except the mounting bracket side.

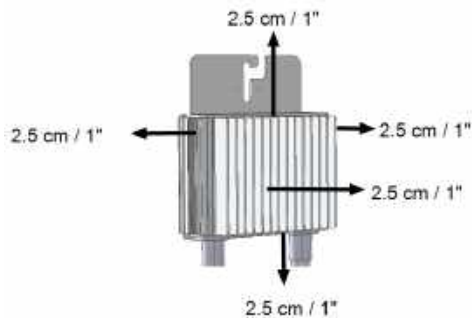

Figure 2: Power optimizer clearance

- When installing modules in a confined space, for example, if installing Building-integrated photovoltaic (BIPV) modules, ventilation measures may be needed to ensure the power optimizers are not be exposed to temperatures outside their specifications.

Step 1: Mounting the Power Optimisers

For each of the power optimizers⁽¹⁾:

1. Determine the power optimizer mounting location and use the power optimizer mounting brackets to attach the power optimizer to the support structure. It is recommended to mount the power optimizer in a location protected from direct sunlight. For frame-mounted power optimizers follow the instructions supplied with the optimizers, or refer to https://www.solaredge.com/sites/default/files/installing_frame_mounted_power_optimizers.pdf.
2. If required, mark the mounting hole locations and drill the hole.



CAUTION!



Drilling vibrations may damage the power optimizer and will void the warranty. Use a torque wrench or an electric drill with adjustable clutch that meets the mounting torque requirements. *Do not* use impact drivers for mounting the power optimizer.

Do not drill through the power optimizer or through the mounting holes.

3. Attach each power optimizer to the rack using M6 (1/4") stainless steel bolts, nuts and washers or other appropriate mounting hardware. Apply torque of 9-10 N*m / 6.5-7 lb*ft.
4. Verify that each power optimizer is securely attached to the model support structure.
5. Record power optimizer serial numbers and locations, as described in *Reporting and Monitoring Installation Data* on page 54.

Step 2: Connecting a PV Module to a Power Optimizer



NOTE

Images are for illustration purposes only. Refer to the label on the product to identify the plus and minus input and output connectors.

For each of the power optimizers:

- Connect the Plus (+) output connector of the module to the Plus (+) input connector of the power optimizer.
- Connect the Minus (-) output connector of the module to the Minus (-) input connector of the power optimizer.

⁽¹⁾Not applicable to smart models.

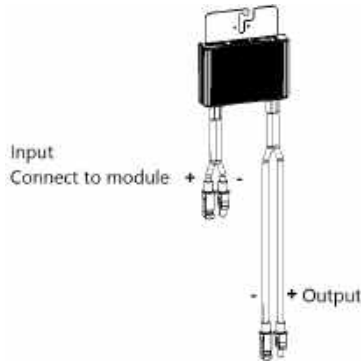

Figure 3: Power optimizer connectors

Step 3: Connecting Power Optimisers in Strings

You can construct parallel strings of unequal length, that is, the number of power optimisers in each string does not have to be the same. The minimum and maximum string lengths are specified in the power optimizer datasheets. Refer to the [Designer](#) for string length verification.



1. Connect the Minus (-) output connector of the string’s first power optimizer to the Plus (+) output connector of the string’s second power optimizer.
2. Connect the rest of the power optimisers in the string in the same manner.

WARNING!



If using a dual-input power optimizer and some inputs are not used, seal the unused input connectors with the supplied pair of seals.

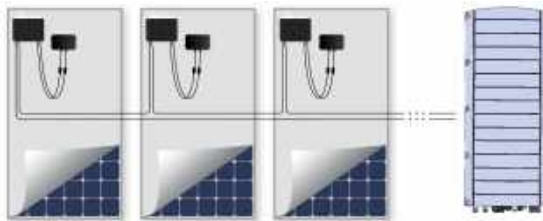

Figure 4: Power optimizers connected in series

3. If you intend to monitor the installation, using the monitoring platform, record the physical location of each power optimizer, as described in *Creating Logical and Physical Layout using Installation Information* on page 55.

Step 4: Verifying Proper Power Optimiser Connection

When a model is connected to a power optimizer, the power optimizer outputs a safe voltage of 1V ($\pm 0.1V$). Therefore, the total string voltage should equal 1V times the number of power optimizers connected in series in the string. For example, if 10 power optimizers are connected in a string, then 10V should be produced.

Make sure the PV models are exposed to sunlight during this process. The power optimizer will only turn ON if the PV model provides at least 2W.

In SolarEdge systems, due to the introduction of power optimizers between the PV models and the inverter, the short circuit current I_{SC} and the open circuit voltage V_{OC} hold different meanings from those in traditional systems.

For more information about the SolarEdge system's string voltage and current, refer to the V_{OC} and I_{SC} in *SolarEdge Systems Technical Note*, available on the SolarEdge website at:

https://www.solaredge.com/sites/default/files/isc_and_voc_in_solaredge_systems_technical_note.pdf



→ To verify proper power optimizer connection:

Measure the voltage of each string individually before connecting it to the other strings or to the inverter. Verify correct polarity by measuring the string polarity with a voltmeter. Use a voltmeter with at least 0.1V measurement accuracy.



NOTE

Since the inverter is not yet operating, you may measure the string voltage and verify correct polarity on the DC wires inside the StorEdge Connection Unit.

For troubleshooting power optimizer operation problems, refer to *Power Optimiser Troubleshooting* on page 60.

Chapter 3: Installing the Inverter

Install the inverter either before or after the modules and power optimizers have been installed.



CAUTION!

Do not rest the connectors at the bottom of the inverter on the ground, as it may damage them. To rest the inverter on the ground, lay it on its back.

Inverter Package Contents

- One StorEdge inverter
- One mounting bracket
- Two Allen screws for fastening the inverter to the mounting bracket
- Installation guide
- Two 48 mm ferrite beads
- One 39 mm ferrite bead
- Lugs and M8 screws for connecting battery cables on the inverter side
- Heat-shrink tubing

Identifying the Inverter

Refer to the sticker on the inverter that specifies its **Serial Number** and its **Electrical Ratings**. Provide the serial number when contacting SolarEdge support. The serial number is also required when opening a new site in the SolarEdge monitoring platform.

Inverter Interfaces

The following figure shows the inverter connectors and components, located at the bottom of the inverter.

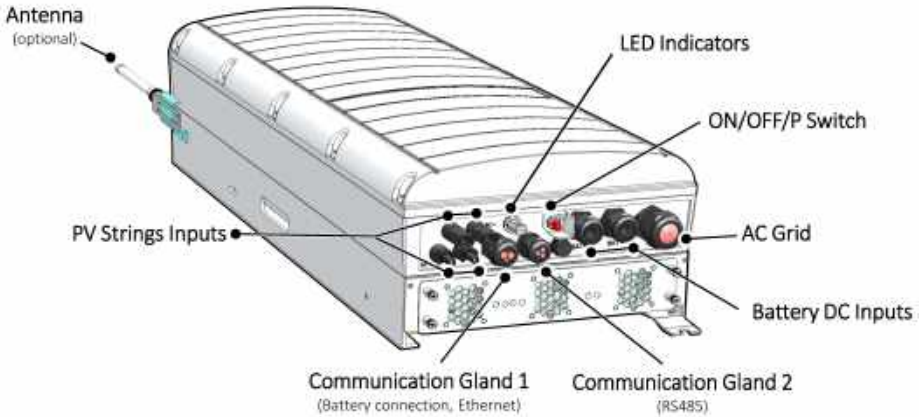

Figure 5: Inverter Interfaces

- **AC output:** AC output gland, AC cable external gauge, M32 (15-21mm diameter) for connection to the grid
- **DC input:** MC4 connector, for connection of the PV installation.
- **Two communication glands:** for connection of inverter communication options. Each gland has three openings. Refer to *Setting Up Communication to the Monitoring Platform* on page 52 for more information.
- **Battery DC inputs:** Two battery glands for connecting charging cables (+ and -)
- **ON/OFF/P switch:**



P = Program/Pair
 1 = ON
 0 = OFF

Figure 6: ON/OFF/P switch

- **ON (1)** - Turning this switch ON (after optimizer pairing) starts the operation of the power optimizers, enables power production and allows the inverter to begin exporting power to the utility grid.
- **OFF (0)** - Turning this switch OFF reduces the power optimizer voltage to a low safety voltage and inhibits exportation of power. When this switch is OFF, the control circuitry remains powered up.
- **P** - Moving and releasing the switch allows viewing system information via the LEDs, and performing the following functions:

P Position Duration	Function	Comments
Switch moved to P for 2 seconds , then released.	<ul style="list-style-type: none"> ■ Displays (via LEDs) production information for 5 seconds, or error type indications (if exist) for 5 seconds. ■ Activates the Wi-Fi access point for connecting to the SetApp 	<p>While the switch is in P, all LEDs are ON.</p> <p>When the switch is released all LEDs turn OFF for 0.5 sec and then display the production or error indication.</p>
Switch moved to P for more than 5 seconds , then released.	Starts pairing	Pairing is indicated by all 3 LEDs blinking simultaneously.

- **LEDs:** three LEDs indicate, by color and state (on/ off/ blinking⁽¹⁾/ flickering⁽²⁾/alternating⁽³⁾), different system information, such as errors or performance indications.





(1)Blinking = Turns ON and OFF for the same duration

(2)Flickering = Turns ON for 100 mS and turns OFF for 5 seconds

(3)Alternating = alternate LED flashes

For more information, refer to <https://www.solaredge.com/leds>.

The main LED indications are:

-  Blue ON - the inverter is communicating with the monitoring platform
-  Green ON - the system is producing
-  Green blinking - AC is connected but the system is not producing
-  Red ON - system error

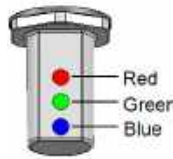

Figure 7: LEDs

The following table describes system performance information by LED color and ON/OFF/P switch position.

Indication	ON/ OFF/ P Switch Position	LED Color			Comment
		Red	Green	Blue	
Power optimizers not paired	ON (1)	OFF	Blinking	<ul style="list-style-type: none"> ▪ S_OK: ON ▪ No S_OK: OFF 	S_OK: ON communication with the monitoring platform is established.
Pairing		Blinking	Blinking	Blinking	
Wake-up/ Grid Monitoring		OFF	Blinking	Blinking	
System Producing		OFF	ON	<ul style="list-style-type: none"> ▪ S_OK: ON ▪ No S_OK: OFF 	
Night mode (no production)		OFF	Flickering	<ul style="list-style-type: none"> ▪ S_OK: ON ▪ No S_OK: OFF 	

Indication	ON/ OFF/ P Switch Position	LED Color			Comment
		Red	Green	Blue	
Inverter is OFF (Safe DC)	OFF (0)	OFF	Blinking	<ul style="list-style-type: none"> ▪ S_OK: ON ▪ No S_OK: OFF 	
Inverter is OFF (DC not safe)		Blinking	Blinking	<ul style="list-style-type: none"> ▪ S_OK: ON ▪ No S_OK: OFF 	
Inverter configuration or reboot	ON / P	ON	ON	ON	
Inverter firmware upgrade	ON / P	Alternating	Alternating	Alternating	The upgrade process can take up to 5 minutes
Error	Any	ON	ON/ OFF/ Blinking/ Flickering	ON/ OFF / Blinking	Refer to "Errors and Troubleshooting" on page 57.

The following table describes production percentage of AC information by LED color and ON/OFF/P switch position.

Indication	ON/ OFF/ P Switch Position	LED Color			Comment
		Red	Green	Blue	
Percentage of AC Production: 0 %	ON (1)	OFF	OFF	OFF	This indicates power production as percentage of rated peak AC output power
Percentage of AC Production: 0 - 33 %		OFF	ON	OFF	
Percentage of AC Production: 33 - 66 %		OFF	OFF	ON	
Percentage of AC Production: 66 - 100 %		OFF	ON	ON	

Mounting the Inverter

The inverter is supplied with a mounting bracket.

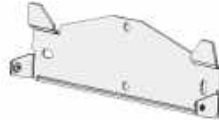

Figure 8: Mounting bracket

NOTE



Make sure the mounting surface or structure can support the weight of the inverter and bracket, and make sure that it spans the width of the bracket.

CAUTION!



HEAVY OBJECT. To avoid muscle strain or back injury, use proper lifting techniques, and if required - a lifting aid.

CAUTION!



SolarEdge inverters and power optimizers can be installed at a minimum distance of 50 m/ 164 ft from the shoreline of an ocean or other saline environment, as long as there are no direct salt water splashes on the inverter or power optimizer.

1. Determine the inverter mounting location, on a wall, stud framing or pole. It is recommended to mount the inverter in a location protected from direct sunlight.
2. To allow proper heat dissipation, maintain the following minimum clearance areas between the inverter and other objects:
 - If installing a single inverter:
 - At least 20 cm (8") from the top and bottom of the inverter.
 - 10 cm (4") from the right and left of the inverter. For easy access to the fans, a larger clearance is recommended.
 - If installing multiple inverters, following the guidelines for three phase inverters in [Clearance Guidelines for Multiple Inverter Mounting](#).



3. Position the mounting bracket against the wall/pole and mark the drilling hole locations :
 - Ensure that the flat edge of the bracket is at the bottom, as in *Figure 9*.
 - Use at least two bracket holes. Additional holes can be used to fix the bracket. Determine which and how many holes to use according to mounting surface type and material.
4. Drill the holes and mount the bracket. Verify that the bracket is firmly attached to the mounting surface.

NOTE

When mounting an inverter on an uneven surface, you may use spacers/washers behind the top mounting hole of the bracket. Depending on the angle, use the appropriate size and number of spacers so that the bracket is perpendicular to the ground. Recommended: a stainless steel 3/4" long screw, with a 1/4" socket button head , two jam nuts and three washers.

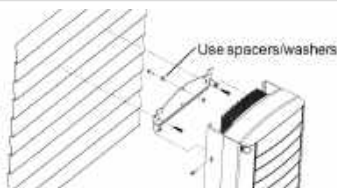

5. Hang the inverter on the bracket (see *Figure 9*): Lift the inverter from the sides, or hold it at the top and bottom of the inverter to lift the unit into place.
6. Align the two indentations in the inverter enclosure with the two triangular mounting tabs of the bracket, and lower the inverter until it rests on the bracket evenly.

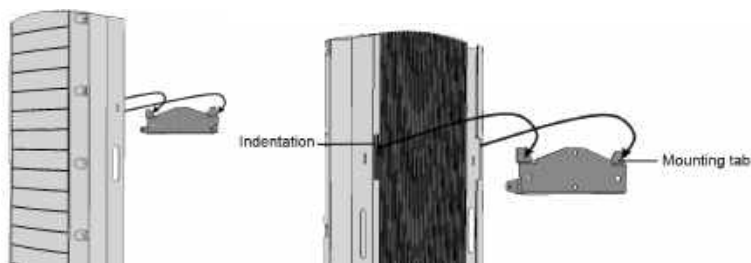

Figure 9: Hanging the inverter on the bracket

7. Insert the two supplied screws through the outer heat sink fins on both sides of the inverter and into the bracket (see *Figure 9*). Tighten the screws with a torque of 4.0

N*m / 2.9 lb.*ft.

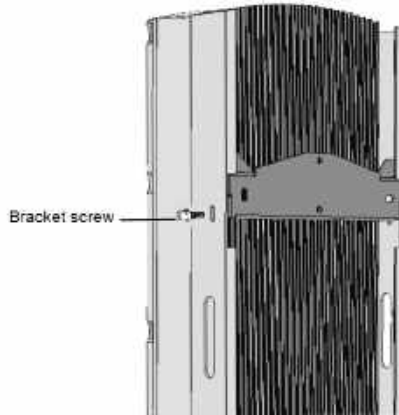

Figure 10: Inserting the bracket screws

8. Fasten the inverter to the surface using the bottom bracket.

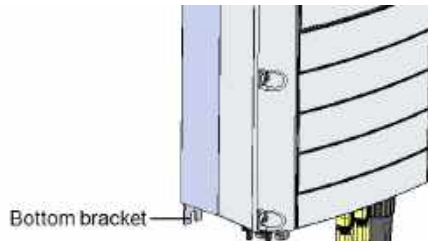

Figure 11: Bottom bracket

9. Remove the inverter cover: Open the inverter cover's ten Allen screws and carefully pull the cover horizontally before lowering it.

Selecting a Residual Current Device (RCD)

IMPORTANT SAFETY FEATURE

All SolarEdge inverters incorporate a certified internal Residual Current Device (RCD) in order to protect against possible electrocution and fire hazard in case of a malfunction in the PV array, cables or inverter. There are two trip thresholds for the RCD as required for certification (DIN VDE 0126-1-1). The default value for electrocution protection is 30 mA, and for slow rising current is 300 mA.



If an external RCD is required by local regulations, check which type of RCD is required for the relevant electric code. Install the residual-current device (RCD) in accordance with the applicable local standards and directives. SolarEdge recommends using a type-A RCD. The recommended RCD value is 100 mA or 300 mA unless a lower value is required by the specific local electric codes. When required by local regulations, the use of an RCD type B is permitted.

**NOTE**

For multiple inverters, an RCD per inverter is required.

In installations where the local electric code requires an RCD with a lower leakage setting, the discharge current might result in nuisance tripping of the external RCD. The following steps are recommended to avoid nuisance tripping of the external RCD:

- Select the appropriate RCD for correct operation of the installation: An RCD with a rating of 30 mA may actually trip at a leakage as low as 15 mA (according to IEC 61008). High quality RCDs will typically trip at a value closer to their rating.
- Configure the trip voltage of the inverter's internal RCD to a lower value than the trip current of the external RCD. The internal RCD will trip if the current is higher than the allowed current, but because the internal inverter RCD automatically resets when the residual currents are low it saves the manual reset.

For detailed information, refer to the *RCD Selection for SolarEdge Inverters Application Note*, available on the SolarEdge website at http://www.solaredge.com/sites/default/files/application_note_ground_fault_rcd.pdf.



Chapter 4: Installing the Battery

Install the battery in accordance with the manufacturer instructions.

In addition, follow these guidelines:

- Make sure the battery's circuit breaker switch is OFF.
- For easy access to battery connectors, it is recommended to connect the cables to the battery and to set all battery DIP switches to their correct positions *before* mounting the battery.
- Measure the necessary length between the inverter and the battery for all cables.
- Mark polarity on DC cables.
- Mount the battery, if applicable.

Chapter 5: Connecting the Inverter

This chapter explains how to connect the inverter to:

- AC grid
- DC strings of modules with power optimizers
- Energy Meter
- Battery

Connecting the AC Grid

Use a five-wire cable. The maximum wire size for the input terminal blocks is 4 mm².

1. Turn OFF the AC circuit breaker.
2. Unscrew the ten Allen screws holding the inverter cover and remove the cover.

CAUTION!



When removing the cover, make sure not to damage internal components. SolarEdge will not be held responsible for any components damaged as a result of incautious cover removal.

3. Strip 60 mm / 2.4" of the external cable insulation and strip 8 mm / 0.32" of the internal wire insulation.

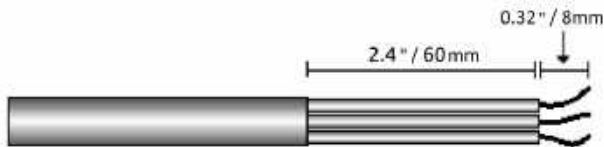

Figure 12: Insulation Stripping – AC Cable

4. Open the AC gland and insert the AC cable through the gland.

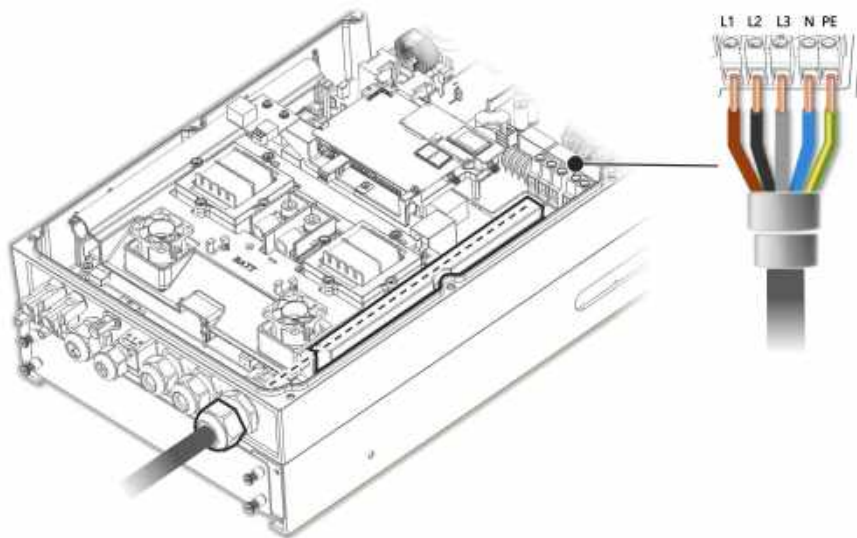

Figure 13: Connection to the AC Grid

5. Pass the cable through the tunnel.
6. Thread the AC cable through two ferrite beads supplied with the inverter: one 48 mm and one 39 mm.
7. Connect the AC cable to the AC terminals. Connect the PE (grounding) wire first.
8. Tighten the terminal block screws with a torque of 1.2-1.5 N*m / 0.88-1.1 lb*ft.
9. Check that the wires are fully inserted and cannot be pulled out easily.
10. Tighten the AC gland with a torque of 2.8-3.3 N*m / 2.0-2.4 lb*ft.
11. Verify that there are no unconnected wires to the inverter and that the unused terminal screws are tightened.

Connecting the Strings to the Inverter

Connect the string to the DC input pairs. If required, connect additional strings in parallel using an external combiner box/branch cables before connecting to the inverter.

NOTE



Functional electrical earthing of DC-side negative or positive poles is prohibited because the inverter has no transformer. Grounding (earth ground) of module frames and mounting equipment of the PV array modules is acceptable.

NOTE



SolarEdge's fixed input voltage architecture enables the parallel strings to be of different lengths. Therefore, they do not need to have the same number of power optimizers, as long as the length of each string is within the permitted range.

Connect the DC connectors of each string to the DC+ and DC- connectors. See *Figure 5*.

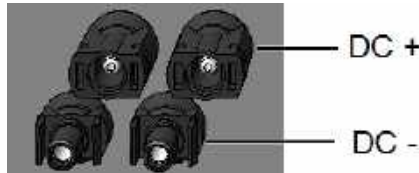

Figure 14: Inverter DC Connections

Connecting the Energy Meter

For Smart Energy Management applications, such as maximizing self-consumption, the StorEdge solution requires an Energy Meter.

To install the Energy Meter, refer to the installation guide supplied with it:

<http://www.solaredge.com/files/pdfs/solaredge-meter-installation-guide.pdf>.



Use a 3-wire shielded twisted pair cable, 0.2 (0.2-1) mm² 600V or CAT5.

→ **To connect the Energy Meter to the inverter**

1. Connect one end of the communication cable to the Energy Meter, as explained in the Energy Meter's installation guide.

2. Open Communication Gland 2 and insert the other end of the communication cable through the gland.

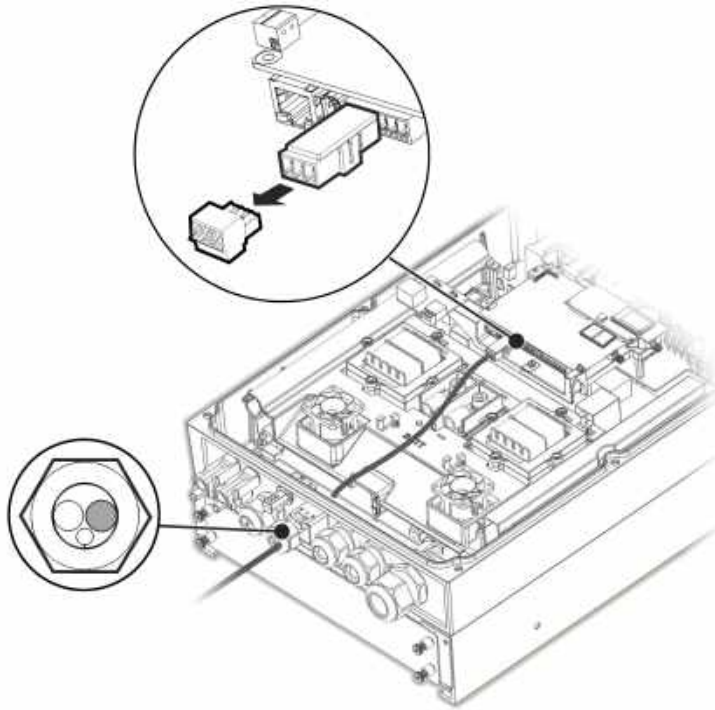

Figure 15: Meter Connection

3. Remove the 3-pin connector from the RS485-1 port on the communication board and loosen its screws.

4. Insert the meter wires into the connector as shown below and tighten them with the screws.

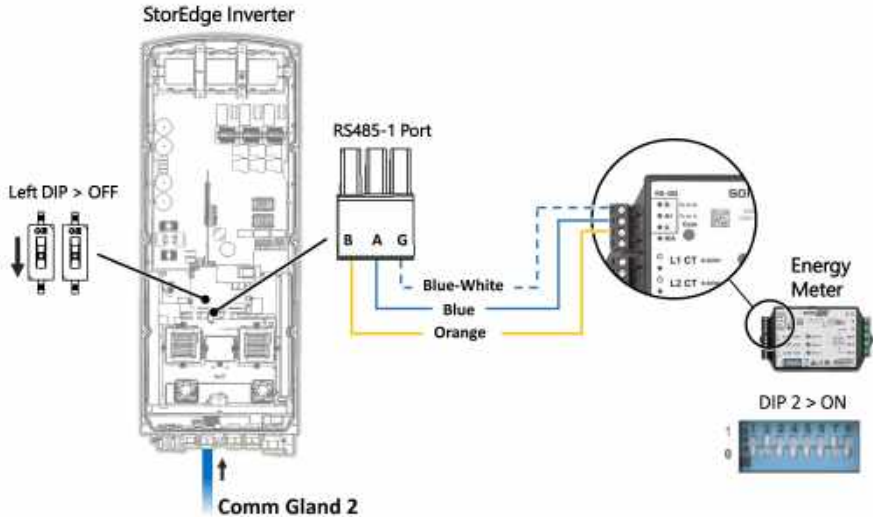

Figure 16: Meter Connection 2

5. Connect the connector back to the RS485-1 port.
6. Make sure the RS485-1 DIP switch (the left switch) is OFF.
7. Make sure the Energy Meter's DIP switch 2 is ON.

Connecting the Battery



WARNING!

The battery must be powered off before and during wiring.

For connecting the battery to the inverter, use copper cables with the following parameters:

- Maximum length: 5m
- Cross-section area: 35 or 50 mm²

Connecting DC Cables

1. Make sure the battery circuit breaker is OFF.
2. Make sure DC to the inverter is OFF.
3. Strip the required length of the battery's DC cables.

4. Crimp the supplied lugs on the power cables and tighten them with the heat shrinks.
5. Remove the plastic cover from the battery terminals.

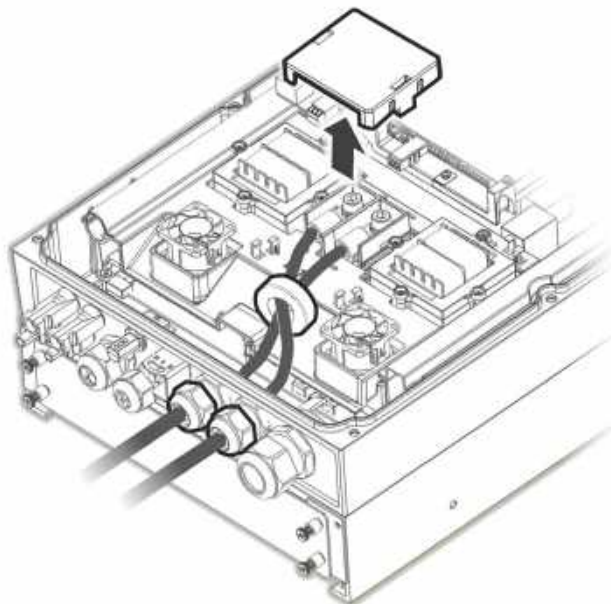

Figure 17: Connection of Battery DC Cables to the Inverter

6. Pass the non-crimped ends of the DC cables through a 48 mm ferrite bead supplied with the inverter.
7. Pass the non-crimped ends of the DC cables from the inside of the inverter outwards, through the battery DC input glands. The correct polarity is marked on the inverter.

WARNING!



Make sure to connect the power cables at correct polarity. Connecting the power cables at reverse polarity may result in damage to the inverter or battery.

8. Connect the DC cables to the battery terminals of the inverter. Tighten the terminals with the supplied M8 screws with a torque of 5N*m/3.7lb*ft.
9. Reinstall the plastic cover on the inverter's battery terminals.
10. Tighten the battery DC input glands.

Connecting the CAN Bus Cable

Communication between the inverter and battery is established using the Controlled Area Network (CAN) bus. Use a shielded Ethernet cable (CAT5/5E STP).

1. Pass the CAN bus cable through Communication Gland 1.

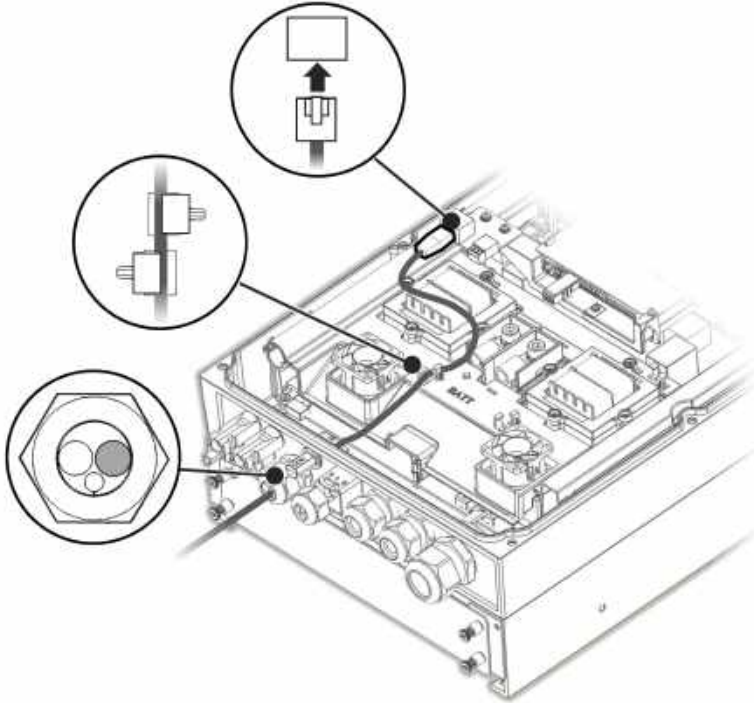

Figure 18: Connection of CAN Cable from Battery to Inverter

2. Connect the cable to the CAN bus connector.
3. Set the DIP switches on the CAN bus board:

- Two right DIP switches - Switch to ON.
- Left DIP switch (PIN 2 - PIN 6) - Selects a grounding PIN for the CAN bus connector. Set according to battery manufacturer's instructions.

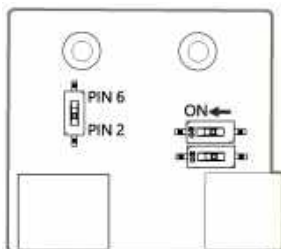

Figure 19: DIP switch set-up on the CAN board

Connecting the Grounding Cable

- Connect the grounding cable from the battery to the grounding hole on the side of the inverter, as shown below. Use an M6 screw.

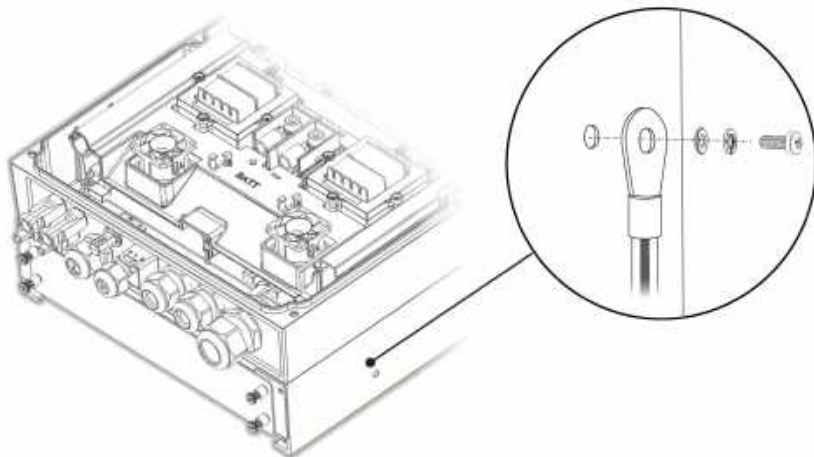

Figure 20: Grounding the battery

Chapter 6: Activating, Commissioning and Configuring the System

You can connect communication options at this stage, as described in *Setting Up Communication to the Monitoring Platform* on page 52.

Once all connections are made, the system should be activated and commissioned using the Inverter SetApp mobile application. You can download the app from the Apple App Store and Google Play prior to reaching the site.



Internet connection is required for the download and for the one-time registration, however not required for using the SetApp.

Step 1: Activating the Installation

During system activation, a Wi-Fi connection is created between the mobile device and the inverter and the system firmware is upgraded.

Before activation - download, register (first time only) and log-in to SetApp on your mobile device. Internet connection is required for the download and for the one-time registration. Verify that the application is updated with the latest version.

→ **To activate the inverter:**

1. Turn ON the AC circuit breaker on the main distribution panel.
2. Open SetApp and follow the instructions on the screen (scan the inverter bar-code; move the ON/OFF/P switch to P position for 2 seconds and release). SetApp creates a Wi-Fi connection, upgrades the inverter CPU firmware and activates the inverter.

3. When the activation is complete, do one of the following:

- Select **Activate Another Inverter** to continue activating additional inverters.
- Select **Start Commissioning** for pairing and other system configuration. The Commissioning screen is displayed. Refer to the next section for more information.

Step 2: Commissioning and Configuring the Installation

This section describes how to use the SetApp menus for commissioning and configuring the inverter settings.

Menus may vary in your application depending on your system type.



→ To access the Commissioning screen:

Do one of the following:

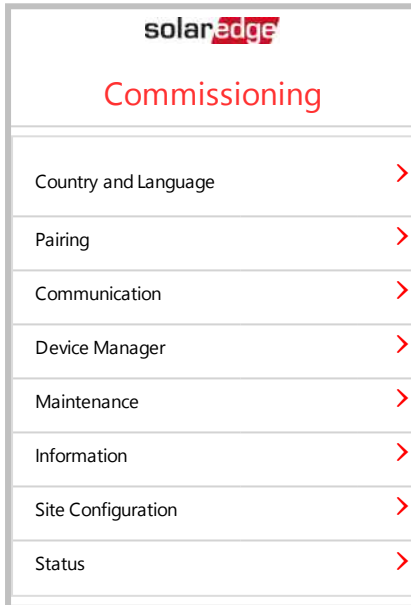
- During first time installation: Upon Activation completion, in the SetApp, tap **Start Commissioning**. The main Commissioning menu screen is displayed.



- If the inverter has already been activated and commissioned:

-  If not already ON - turn ON AC to the inverter by turning ON the circuit breaker on the main distribution panel.
-  Open SetApp and follow the on-screen instructions (scan the inverter bar-code, move the ON/OFF/P switch to P position for 2 seconds and release).
The mobile device creates a Wi-Fi connection with the inverter and displays the main Commissioning screen.

In the main menus, tap the menu red arrows (➤) to perform the system commissioning or configuration task. Tap the **Back** arrow (◀) to return to the previous menu.

The next sections provide more information about configuration options (in addition to **Country and Language** and **Pairing**, described in *Step 2: Commissioning and Configuring the Installation* on page 38).

Setting Country and Language

1. From the Commissioning screen select **Country and Language** .
2. From the **Country** drop-down list, select the required country setting.

WARNING!



The inverter must be configured to the proper setting in order to ensure that it complies with the country grid code and functions properly with the country grids.

3. From the **Language** drop-down list, select the language.
4. Tap **Set Language**.

Pairing

Once all connections are made, all the power optimizers must be logically paired to their inverter. The poweroptimizers do not start producing power until they are paired. This step describes how to assign each inverter to the poweroptimizers from which it will produce power.

Perform this step when the modules are exposed to sunlight. If the string length is changed or a power optimizer is replaced, repeat the pairing process.

1. From the main menu, select **Pairing**.
2. Tap **Start Pairing**.
3. When **Pairing Complete** is displayed, the system startup process begins:
Since the inverter is ON, the power optimizers start producing power and the inverter starts converting AC.

**WARNING!**

When you turn ON the inverter ON/OFF/P switch, the DC cables carry a high voltage and the power optimizers no longer output a safe 1V output.

When the inverter starts converting power after the initial connection to the AC, the inverter enters Wakeup mode until its working voltage is reached. This mode is indicated by the flickering green inverter LED.

When working voltage is reached, the inverter enters Production mode and produces power. The steadily lit green inverter LED indicates this mode.

4. Tap **OK** to return to the main menu.

Communication

Communication settings can be configured only after communication connections are complete. Refer to *Setting Up Communication to the Monitoring Platform* on page 52.

1. Select the **Communication** menu to define and configure the following:
 - The communication option used by the inverter to communicate with the monitoring platform.
 - The communication option used to communicate between multiple SolarEdge devices or other external non-SolarEdge devices, such as electricity meters or loggers.
2. Tap the **Server** red arrow to set the communication method to be used for communication between devices and the SolarEdge monitoring platform. The default is LAN.

**NOTE**

The Server menu shows only the communication options installed in the inverter.

For detailed information about all the configuration options, refer to the *Communication Options Application Note*, available on the SolarEdge website at https://www.solaredge.com/sites/default/files/solaredge-communication_options_application_note_v2_250_and_above.pdf.



Power Control

The Grid Control option may be disabled. Enabling it opens additional options in the menu.

The Energy Manager option is used for setting power export limitation, as described in the *Export Limitation Application Note*, available on the SolarEdge website at https://www.solaredge.com/sites/default/files/feed-in_limitation_application_note.pdf.



Device Manager

From the **Commissioning** menu, select **Device Manager** to configure various system Smart Energy Management devices.

For more information refer to

<https://www.solaredge.com/products/device-control/>.



Maintenance

From the **Commissioning** menu, select **Maintenance** to configure various system settings, as described below.

- **Date and Time:** Set the internal real-time clock. If connected to the monitoring platform, the date and time are set automatically and only time zone should be set.
- **Reset Counters:** Resets the accumulated energy counters that are sent to the monitoring platform.
- **Factory Reset:** Performs a general reset to the default device settings.
- **Arc Fault Circuit Interrupter (AFCI):** Enables or disables production interruption in case of arc-fault, sets the reconnection mode, and enables or disables manual AFCI self-test.

Refer to https://www.solaredge.com/sites/default/files/arc_fault_detection_application_note.pdf.



- **Firmware Upgrade:** Perform a software upgrade.
- **Diagnostics:** Displays the Isolation status and power optimizer status screens. Refer to https://www.solaredge.com/sites/default/files/application_note_isolation_fault_troubleshooting.pdf.
- **Activate Standby Mode:** Enables/disables Standby Mode - for remote commissioning.
- **Board Replacement:** Backs up and restores the system parameters, including energy counters; Used during board replacement according to the instructions supplied with replacement kits.



Information

From the **Commissioning** menu, select **Information** to view and set various system settings, as described below.

- **CPU Version:** The communication board firmware version
- **DSP 1/2 Version:** The digital board firmware version



NOTE

Please have these numbers ready when you contact SolarEdge Support.

- **Serial Number:** The inverter serial number as appears on the enclosure sticker
- **Error Log:** Displays the last five errors, and enables resetting (clearing) the log
- **Warning Log:** Displays the last five warnings, and enables resetting (clearing) the log

Step 3: Verifying Proper Activation and Commissioning

1. Select **Information** and verify that the correct firmware versions are installed on each inverter.
2. Select **Status** and verify that inverter is operating and producing power (see also *Viewing System Status* on page 44).
3. Verify that the number of paired optimizers is the same as the number of physically installed power optimizers.
4. Verify that additional configurations were properly set by viewing the relevant Status screens.
5. Verify that the green inverter LED is steadily lit.

Your SolarEdge power harvesting system is now operational.

Configuring Communication with the Energy Meter

1. Switch the inverter ON/OFF/P switch to OFF.
2. Access SetApp and select **Commissioning** → **Communication**.
3. From the **Communication** screen, select **RS485-1** → **Protocol** → **Modbus (Multi-Device)**.
4. In the **RS485-1** screen, select **Add Modbus Device** → **Meter**.
The meter is automatically identified.

- Set the Energy Meter's **CT Rating** according to the CT specifications.
- Select **Meter 1** → **Meter Function** → **Export+Import (E+I)**.

Configuring Communication with the Battery

- Make sure the battery's circuit breaker switch is ON.
- Switch the inverter ON/OFF/P switch to OFF.
- Access SetApp and select **Commissioning** → **Communication**.
- Tap **CAN**.
- On the **Batteries** screen that opens, select your battery type from the list.

Running a Battery Self-test

Run a battery self-test to check the battery's charge and discharge functionality.

→ To run a battery self-test:

- Make sure the battery's circuit breaker switch is ON.
- Switch the inverter ON/OFF/P switch to ON.
- In SetApp, select **Commissioning** → **Maintenance** → **Diagnostics** → **Self-Test** → **Battery Self-Test** → **Run Test**.
- Wait for all tests to complete and check the results in the summary table.
If any of the tests have failed, see the table below for possible solutions:

Test Results	Solution
Charge failed	Check that the power and communication cables between the battery and inverter are properly connected.
Discharge failed	Check that the power and communication cables between the battery and inverter are properly connected.
Communication	Check that the communication cables between the battery and inverter are properly connected.
Inverter switch is off	Switch the inverter ON/OFF/P switch to ON.

→ To show the last test results:



- Select **Commissioning** → **Maintenance** → **Diagnostics** → **Self-Test** → **Battery Self-Test** → **Show Last Results**.

Configuring StorEdge Applications

Maximize Self-consumption (MSC)



In this mode, the battery is automatically charged and discharged to meet consumption needs.

The battery has two states:

-  OFF – the battery is in standby
-  ON – the battery is controlled for maximized self-consumption

Battery OFF periods can be configured to extend battery lifetime by minimizing the number of shallow discharges (for example at nighttime or during the winter).

→ To set up maximize self-consumption:

1. Access SetApp and select **Commissioning** → **Power Control**.
2. Select **Energy Manager** → **Energy Control** → **Maximum Self Consumption**.
3. Optionally, set the battery OFF periods as follows:
 - a. Select **Set Operation**, and then select a month from the list that appears.
 - b. Select a month. A list of options is displayed.
 - c. Select one of the options:
 -  Select **Always OFF** to avoid battery usage entirely (for example during winter)
 -  Set **Start Time** and **End Time** to set battery usage in specific hours and avoid usage during specific hours throughout the month (for example at night). This sets the periods during which the battery will be in the OFF state.
 -  Select **Always ON** to use battery at all times for charging/ discharging.

Viewing System Status

During normal operation, the **Status** screen displays all the inverter settings and operation status. Scroll up or down to display various status parameters as described in the following sections.

The LED indication provides more information about system performance; Refer to



→ To access the Status screen:



From the **Commissioning** menu select **Status**. The main inverter Status screen is displayed (see below).

A red or orange icon (for example: ) may appear at the top left corner of a status cell, indicating an error. The color indicates error severity (red is top severity). The error description or information appears on the screen. Tap the error line for more information and troubleshooting instructions, and refer to "Errors and Troubleshooting" on page 57.

A gray clock icon () may appear at the top left corner of a status cell, indicating a temporary status, such as a connection process. When the process is complete, the icon disappears and a constant status message is displayed.

Main Inverter Status

solar edge		
Status		
Inverter		
SN 07318000C		
Power	Voltage	Frequency
100 kW	277 Vac	60.9 Hz
 P_OK: 138 of 141	Server Comm.	
Optimisers Connected	S_OK (LAN)	
Status	 Switch	
Production	OFF	
CosPhi	Limit	Country
1.00	No Limit	Netherlands
Voltage	Temp	Fan
850 Vdc	20 C	OK N/A
 Switch Off. Production disabled >		
Commissioning >		



-  **Inverter:** The inverter serial number
-  **Power:** The AC output power
-  **Voltage (Vac):** The AC output voltage

- **Frequency:** The AC output frequency
- **P_OK: xxx of yy:** There is a connection to the power optimizers and at least one power optimizer is sending monitoring data. XXX is the number of power optimizers for which telemetries have been received in the last two hours. YYY is the number of paired power optimizers identified during the most recent pairing process. If XXX and YYY are not equal, there may be a problem in one or more power optimizers.
- **S_OK:** The connection to the monitoring platform. (**Server Connected** appears only if the inverter is connected to the monitoring platform).
- **Status:** The inverter operation status: Off, Not Paired, Night Mode, Error, Pairing, or Production.
- **Switch:** Indicates the position of the inverter ON/OFF/P switch: On, Off, or P position.
- **CosPhi:** Indicates the ratio between active and reactive power. A negative value indicates a lagging CosPhi.
- For more information, refer to the *Power Control Application Note*, available on the SolarEdge website at https://www.solaredge.com/sites/default/files/application_note_power_control_configuration.pdf.
- **Limit:** The inverter maximum output power
- **Country:** The selected country and grid setting
- **Voltage (Vdc):** The DC input voltage
- **Temp** (°C or °F): The inverter heat sink temperature





Site Status

The Site status screen shows the accumulated status of all inverters connected to a master inverter in a chain (bus) and the master inverter status.

solar edge		
Status		
Site		
Production	Limit	Inverters
1.00 MW	1.00 MW	10/10
Inverter		
SN 07318000C		
Power	Voltage	Frequency
100 kW	277 Vac	60.9 Hz
P_OK: 141 Of 141	S_OK	
Optimisers Connected	Server Connected	
Status		Switch
Production		OFF
CosPhi	Limit	Country
1.00	Export	ITA
 Switch Off. Production disabled >		
Commissioning		>

 Site status:

-  **Production:** The AC output power
-  **Limit:** Limitation setting (Export or Production)
-  **Inverters:** Number of connected inverters in the cluster, including the master

Communication Status

This screen displays the status of connection option(s): LAN, RS485, Wi-Fi, cellular or ZigBee Plug-in.

Communication		
LAN Connected	RS485-1 Modbus 2 of 2	RS485-2 SE Slave None
Cellular N/A	Wi-Fi NC	ZigBee NC







For each communication option, one of the following statuses is displayed:

- **Connected:** The inverter established a successful connection and communication with the specified server port
- **NC:** Not Connected
- **S_OK:** The connection to the monitoring platform is successful (should appear only if the inverter is connected to the server)
- **N/A :** Not Applicable
- **x of y:** Number of devices connected out of all devices
- Temporarily displayed (with a ⌚ clock sign):
 - **Initializing communication**
 - **Connecting** to a network
 - **Connecting** to SolarEdge servers
- **Error message** (with the 🚫 sign)

Inverter Energy Status

Displays the total energy produced during the last day, month, year and since inverter installation.

Inverter Energy		
Today	This Month	This Year
45 kWh	1.14 MWh	13.68 MWh
Total: 41.03 MWh		

-  **Today:** Since midnight
-  **This Month:** Since 1st of the current month
-  **This Year:** Since January 1st
-  **Total (Wh):** The inverter total energy. If an external meter is installed, the value displayed in this line depends on the meter type connected to the inverter and its location:
 -  If a bidirectional meter is connected at the consumption point, this value is the consumed energy.
 -  If the meter is installed at the production point, this value is the energy produced by the site.
 -  If the meter is installed at the grid connection point, this value is the energy exported to the grid.

Meter Status





Meters	
Production Meter	
SN: XXXXXXXX	
RS485-1 Modbus ID #2	Status OK
Power 7.60 kW	Energy 13.68MWh
Export Meter	
SN: XXXXXXXX	
GPIO S0 meter 1000 pulses per kWh	
Power 7.60 kW	Energy 13.68MWh

- **Type and function:** Displays the meter functionality (Production, Export, Import, Export+Import).
- **Status:** Displays OK if the meter is communicating with the inverter.
- **<Error message>:** If there is a meter error, it is displayed in this line.
- **Power:** Depending on the meter type connected to the inverter, this line displays the exported or imported power.
- **Energy:** The total energy read by the meter. The value displayed in this line depends on the meter type connected to the inverter and its location:
 - If a bidirectional meter is connected at the consumption point, this value is the consumed energy.
 - If the meter is installed at the production connection point, this value is the energy produced by the site.
 - If the meter is installed at the grid connection point, this value is the energy exported to the grid. This data is accumulated according to an internal real-time clock.

Battery Status







This screen is displayed only when the battery is configured, and shows the battery identification information, its charging status and power, and the operating mode.

Battery		
<i>StorEdge SN</i>		
Communication		Type
Connected		LGC RESU 10
State	Power	SOE
Discharging	280W	72 %

-  **Communication:** Connection to the inverter
-  **Type:** Battery type
-  **SOE:** State of Energy - the battery capacity percentage (calculated as Available Energy\Max. Energy)
-  **Power:** The charging or discharging power (in Watts) according to the battery state (see below)
-  **State:** The battery status: Charging/ Discharging, Idle, Init (pre-heating) or Fault <error code>.

Charge/ Discharge Profile Programming Status

This screen is displayed only if Charge/ Discharge Profile Programming [Time-of-Use (TOU)] is configured, and shows information about the TOU settings for the site.

-  **Name:** The TOU profile file name
-  **Last Sync:** Date when the time-of-use profile was loaded from the monitoring platform
-  **Source:** the source from which the TOU profile was uploaded:
 -  Remote - Profile uploaded from the SolarEdge monitoring platform
 -  Local - Profile uploaded from an SD card
-  **Set Until:** The date until the current profiles applicable

Chapter 7: Setting Up Communication to the Monitoring Platform

The inverter sends the following information to the monitoring platform:

- Power optimizer information received via the DC power lines (the PV output circuit)
- Inverter information
- Information of any other connected devices

This chapter describes how to set up communication between:

- The inverter and the monitoring platform through the Internet (wired/ wireless)
- Multiple inverters for a master/slave configuration

Communication setup is not required for power harvesting, however it is needed for using the monitoring platform .



NOTE

It is recommended to connect communication connections before connecting the AC, for easier access to the communication board.

CAUTION!



When connecting the communication cables, make sure that the ON/OFF/P switch at the bottom of the inverter is turned OFF, and the AC is turned OFF.

When configuring the communication parameters, make sure that the ON/OFF/P switch is in P position, and the AC is turned ON.

Communication Options

The following types of communication can be used to transfer the monitored information from the inverter to the monitoring platform.

Only communication products offered by SolarEdge are supported.

Ethernet

Ethernet is used for a LAN connection. For connection instructions refer to .

RS485

RS485 is used for the connection of multiple SolarEdge devices on the same bus in a master-slave configuration. RS485 can also be used as an interface to external devices, such as meters and third party data loggers.

Wi-Fi

This communication option enables using a Wi-Fi connection for connecting to the monitoring platform.

The Wi-Fi access point is built into the inverter. An antenna is required and available from SolarEdge for connection to the monitoring platform.

Cellular

This wireless communication option (purchased separately) enables using a cellular connection to connect one or several devices (depending on the data plan used) to the monitoring platform.

The Cellular Plug-in is provided with a user manual, which should be reviewed prior to connection. Refer to

https://www.solaredge.com/sites/default/files/cellular_gsm_installation_guide_for_inverters_with_setapp.pdf



ZigBee

This option enables wireless connection to one or several Smart Energy products, which automatically divert PV energy to home appliances.

The Smart Energy ZigBee connections require a ZigBee plug-in and an external antenna, available from SolarEdge.

The ZigBee Plug-in for Smart Energy is provided with an installation guide, which should be reviewed prior to connection. Refer to

<https://www.solaredge.com/sites/default/files/se-zigbee-plug-in-for-setapp-installation-guide.pdf>

The Smart Energy products are provided with an installation guide, which should be reviewed prior to connection. Refer to

<https://www.solaredge.com/products/device-control#/>.



Verifying the Connection

After connecting and configuring a communication option, perform the following steps to check that the connection to the monitoring server has been successfully established.

1. Check that **S_OK - Server Connected** status appears in the main inverter section.
2. Scroll down to the Communication section and check that the communication options are as required. For more information refer to *Communication Status* on

page 48.

Communication		
LAN Connected	RS485-1 Modbus 2 of 2	RS485-2 SE Slave None
Cellular N/A	Wi-Fi NC	ZigBee NC

Reporting and Monitoring Installation Data



NOTE

Monitoring the site requires connecting the inverter to the monitoring platform, using any of the wired or wireless options available from SolarEdge. Refer to *Setting Up Communication to the Monitoring Platform* on page 52.

The Monitoring Platform

The monitoring platform provides enhanced PV performance monitoring and yield assurance through immediate fault detection and alerts at the model, string and system level.

Using the platform, you can:

- View the latest performance of specific components.
- Find under-performing components, such as models, by comparing their performance to that of other components of the same type.
- Pinpoint the location of alerted components using the physical layout.

The monitoring platform enables accessing site information, including up-to-date information viewed in a physical or logical view:

- **Logical Layout:** Shows a schematic tree-layout of the components in the system, such as: inverters, strings, models, meters and sensors, as well as their electrical connectivity. This view enables you to see which models are connected in each string, which strings are connected to each inverter, and so on.
- **Physical Layout:** Provides a bird's eye view of the actual placement of models in the site, and allows pinpoint issues to the exact location of each model on a virtual site map.

If you do not report the mapping of the installed power optimizers, the monitoring platform will show the logical layout indicating which power optimizers are connected to which inverter, but will not show strings or the physical location of power optimizers.

The monitoring platform includes a built-in help system, that guides you through the monitoring functionality.



For more information, refer to <https://www.solaredge.com/products/pv-monitoring#/>.

Creating Logical and Physical Layout using Installation Information

To display a logical layout, insert the inverter serial number in the new site created in the monitoring platform. When the communication between the inverter and the monitoring server is established, the logical layout is displayed.

To display a physical layout, you need to map the locations of the installed power optimizers. To map the locations, use one of the methods described in the next sections.

Designer

Designer recommends inverter and power optimizer selection per site size and enables report generation. You can create a project in Designer and export the site design with the string layout to the monitoring platform.

For more information, refer to

<https://www.solaredge.com/products/installer-tools/designer#/>.



Mapper Application

Use the Mapper smart phone application to scan the power optimizer and inverter 2D bar-codes and create a virtual map of a PV site for enhanced monitoring and easier maintenance.

The Mapper

- Simple on-site registration of new systems.
- Creating, editing and verifying system physical layout.
- Scanning and assigning the power optimizer serial number to the correct model in the system physical layout.

For detailed information, refer to the *Mapper* demo movies:

- [Creating new sites using the Mapper mobile application](#)



[Mapping existing sites using the Mapper mobile application](#)



Physical Layout Editor

1. If you are a registered installer, access the monitoring platform site creation page at <https://monitoring.solaredge.com/solaredge-web/p/home#createSites>. If you have not yet signed up, go to <https://monitoring.solaredge.com/solaredge-web/p/createSelfNewInstaller>.
2. Fill out all required information in the screen, which includes information about your installation, as well as details about its logical and physical mapping.



Using a Paper Template

Fill out the Physical Layout Template (downloadable from the SolarEdge website <http://www.solaredge.com/files/pdfs/physical-layout-template.pdf>) using the detachable 2D barcode stickers on each power optimizer. Once the form is completed, use the Mapper to scan the 2D codes and create the map in the monitoring platform. Optionally, you can send the sticker sheet to SolarEdge Support for physical layout creation.



Appendix A: Errors and Troubleshooting

This appendix describes general system problems, and how to troubleshoot them. For further assistance, contact SolarEdge Support.

Identifying Errors

Errors may be indicated in various system interfaces: On the inverter bottom panel, a red LED indicates an error. In the monitoring platform and SetApp, errors are displayed with codes. For more information on the codes displayed for error and warning messages, refer to <http://www.solaredge.com/sites/default/files/se-inverter-installation-guide-error-codes.pdf>. This document describes errors that appear in SetApp, monitoring platform, and LCD (for inverters with LCD). To identify the error types, use the methods described below.



→ To identify the error type using the inverter LEDs:

1. Move the ON/OFF/P switch to **P** position for **2 seconds** and release it.
2. Observe the LED lights and use the following table to identify the error type. For more information, refer to <https://www.solaredge.com/leds>.



Error type	LED color and state		
	Red	Green	Blue
Arc detected	ON	OFF	OFF
Isolation or RCD problem	Blinking	OFF	OFF
Grid error	OFF	ON	OFF
High temperature	OFF	Blinking	OFF
Pairing failed	OFF	OFF	ON
Other issue	OFF	OFF	Blinking

→ To identify the error type using the monitoring platform:

1. Open the site dashboard and click the **Layout** icon.
2. Right-click the inverter and select **Info** from the menu. The inverter details window is displayed.
3. Click the **Errors** tab. The list is displayed.

Troubleshooting Communication

Troubleshooting Ethernet (LAN) Communication

The possible errors and their troubleshooting are detailed in the following table:

Error Message	Possible Cause and Troubleshooting
LAN cable disconnected	Physical connection fault. Check the cable pin-out assignment and cable connection.
No DHCP Configure Static IP or set to DHCP	IP settings issue. Check the router and inverter configuration. Consult your network IT.
Gateway not responding	Ping to router failed. Check the physical connection to the switch/ router. Check that the link LED at the router /switch is lit (indicating phy-link). If OK - contact your network IT, otherwise replace the cable or change it from cross to straight connection.
No Internet connection	Ping to google.com failed. Connect a laptop and check for internet connection. If internet access is unavailable, contact your IT admin or your internet provider. For Wi-Fi networks, ensure that user-name and password are as defined in the internet provider AP/ router.

Troubleshooting RS485 Communication

- If the message **RS485 Master Not Found** appears in the Status screen, check the connections to the master device and fix if required.
- If after slave detection the number of slaves displayed for the master under **RS485-2 Conf → Slave Detect** is lower than the actual number of slaves, refer to the following application note to identify missing slaves and troubleshoot connectivity problems: https://www.solaredge.com/sites/default/files/troubleshooting_undetected_RS485_devices.pdf

Additional Troubleshooting

1. Check that the modem or hub/router is functioning properly.
2. Check that the connection to the internal connector on the communication board is properly done.
3. Check that the selected communication option is properly configured.
4. Use a method independent of the SolarEdge device to check whether the network and modem are operating properly. For example, connect a laptop to the Ethernet router and connect to the Internet.
5. Check whether a firewall or another type of network filter is blocking communication.

StorEdge Three Phase Inverter Troubleshooting

Error Code	Error Message	Possible Cause and Troubleshooting
1Dx7D	High battery voltage	Verify that the battery is connected to the inverter as required.
1Dx7E	Low battery voltage	Verify that the battery is connected to the inverter as required.
1Dx88	Internal communication error	Verify that the RS485 connector on the communication board is connected as required.
1Dx89	Internal DC power connection error	Verify that the connection between the DCDC PCB and the inverter PCB is connected as required.
1Dx8A	High DC voltage fault	Verify that the connection between the DCDC PCB and the inverter PCB is connected as required and check for short in string - inverter power connection.
1Dx8D	High battery voltage	Verify that the battery is connected to the inverter as required.
1Dx8E	Low battery voltage	Verify that the battery is connected to the inverter as required
1Dx9F	Battery communication error	Verify that the CAN connectors are connected as required.
1DxA0	Battery error	Call battery vendor support.

1DxA1	Battery not selected	Configure battery as required.
1DxA2	Operation conditions verification failed	Verify that the battery is connected to the inverter as required, battery voltage is within range and the battery is enabled (power and communication).

Power Optimiser Troubleshooting

Problem	Possible Cause and Troubleshooting
Pairing failed	<p>Power optimizers are shaded.</p> <p>If you connected the inverter to the monitoring platform, retry pairing remotely (during sunlight). Make sure to leave the inverter ON/OFF/P switch ON and that S_OK appears in the status screen.</p>
String voltage is 0V	<p>Power optimizer (s) output is disconnected.</p> <p>Connect all power optimizer outputs.</p>
String voltage not 0V but lower than number of optimizers	<p>Power optimizer(s) not connected in the string.</p> <p>Connect all power optimizers.</p>
	<p>Panel(s) not connected properly to power optimizer inputs (not applicable to smart models).</p> <p>Connect the models to the optimizer inputs.</p>
	<p>String reverse polarity.</p> <p>Check string polarity using a voltmeter and correct if needed.</p>

Problem	Possible Cause and Troubleshooting
<p data-bbox="101 512 488 576">String voltage is higher than number of optimizers</p> <div data-bbox="174 587 295 614" style="background-color: #cccccc; padding: 2px;">WARNING!</div> <div data-bbox="112 660 168 715" style="border: 1px solid red; padding: 2px; display: inline-block;">  </div> <p data-bbox="174 624 449 791">If the measured voltage is too high, the installation may not have a safe low voltage. PROCEED WITH CARE! A deviation of $\pm 1\%$ per string is reasonable.</p>	<p data-bbox="492 185 1001 248">Extra power optimizer(s) connected in the string (not applicable to smart models).</p> <p data-bbox="492 260 986 323">Check if an extra power optimizer is connected in the string. If not – proceed to next solution.</p> <p data-bbox="492 335 964 430">A model is connected directly to the string, without a power optimizer (not applicable to smart models).</p> <p data-bbox="492 442 997 571">Verify that only power optimizers are connected in the string and that no model outputs are connected without a power optimizer. If the problem persists, proceed to the next step.</p> <p data-bbox="492 582 829 609">Power optimizer(s) malfunction.</p> <ol data-bbox="492 620 1006 1126" style="list-style-type: none"> <li data-bbox="492 620 990 684">1. Disconnect the wires connecting the power optimizers in the string. <li data-bbox="492 695 995 903">2. Measure the output voltage of each power optimizer to locate the power optimizer that does not output 1V safety voltage. If a malfunctioning power optimizer is located, check its connections, polarity, model, and voltage. <li data-bbox="492 914 1006 1126">3. Contact SolarEdge Support. Do not continue before finding the problem and replacing the malfunctioning power optimizer. If a malfunction cannot be bypassed or resolved, skip the malfunctioning power optimizer, thus connecting a shorter string.

Appendix B: Mechanical Specifications

The following figure provides inverter dimensions in mm [in].

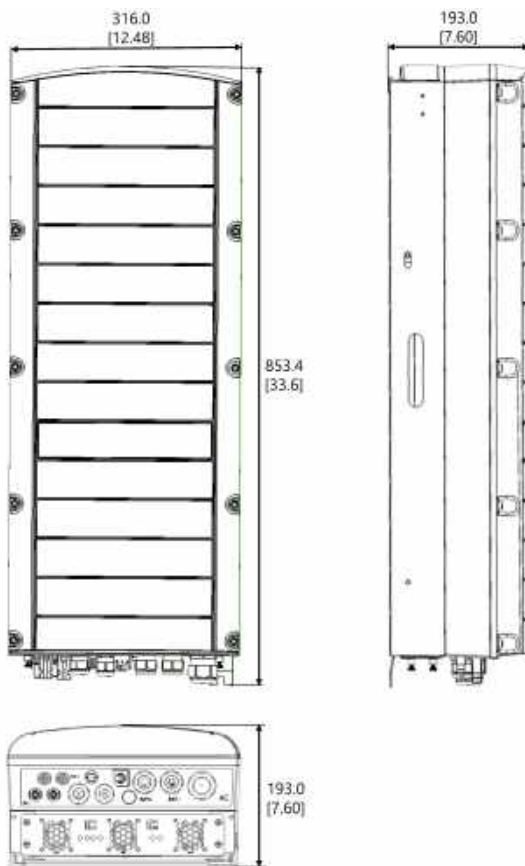

Figure 21: StorEdge Three Phase Inverter dimensions

Appendix C: SafeDC™

When AC supply to the inverter is shut off (by shutting off the AC breaker at the site), or when the inverter ON/OFF/P switch is turned to OFF, the DC voltage drops to a safe voltage of 1V per optimizer.

The SolarEdge inverters are certified for compliance with the following standards as disconnection devices for PV generators, meaning that they can replace a DC disconnect:

- IEC 60947-3:1999 + Corrigendum: 1999 + A1:2001 + Corrigendum 1:2001 + A2:2005;
- DIN EN 60947-3
- VDE 0660-107:2006-03
- IEC 60364-7-712:2002-05
- DIN VDE 0100-712:2006-06.

In compliance with these standards, the disconnection mechanism operates as follows:

1. Turn the inverter ON/OFF/P switch, located at the bottom of the inverter, to OFF, or disconnect the AC by shutting off the AC breaker at the site. The DC voltage displayed on the SetApp screen begins to decrease.
2. When the DC voltage reaches a safe voltage, the PV connectors at the input to the inverter can be disconnected. A galvanic separation then exists between the PV array and the inverter.

WARNING!

SafeDC complies with IEC60947-3 when installing the system with a worst case SafeDC voltage (under fault conditions) < 120V.

The worst case voltage is defined as: $V_{oc,max} + (\text{String Length} - 1) * 1V$, where:



- $V_{oc,max}$ = Maximum V_{oc} (at lowest temperature) of the PV module in the string (for a string with multiple module models, use the max value)
- String Length = number of power optimizers in the string

StorEdge Three Phase Inverter - Technical Specifications

SE5K-RWS / SE7K-RWS / SE8K-RWS / SE10K-RWS⁽¹⁾

	SE5K-RWS	SE7K-RWS	SE8K-RWS	SE10K-RWS	Unit
OUTPUT					
Rated AC Power Output	5000	7000	8000	10000	VA
Maximum AC Power Output	5000	7000	8000	10000	VA
AC Output Voltage — Line to Line / Line to Neutral (Nominal)	380/220 ; 400/230				Vac
AC Output Voltage — Line to Line Range / Line to Neutral Range	184 - 264.5				Vac
AC Frequency	50/60 ± 5				Hz
Maximum Continuous Output Current (per Phase)	8	11.5	13	16	A
Residual Current Detector / Residual Current Step Detector	300 / 30				mA
Grids Supported — Three Phase	3 / N / PE (WYE with Neutral)				
Utility Monitoring, Islanding Protection, Configurable Power Factor, Country Configurable Thresholds	Yes				
INPUT PV					
Maximum DC Power (Module STC)	6750	9450	10800	13500	W
Transformer-less, Ungrounded	Yes				
Maximum Input Voltage	900				Vdc
Nominal DC Input Voltage	750				Vdc
Maximum Input Current	8.5	12	13.5	16.5	A
Reverse-Polarity Protection	Yes				

⁽¹⁾These specifications apply to inverters with Part number: SEXK-XXS48

Ground-Fault Isolation Detection	700kΩ Sensitivity			
Maximum Inverter Efficiency	98			%
European Weighted Efficiency	97.3	97.4	97.6	%
Nighttime Power Consumption	< 2.5			W
INPUT BATTERY				
Maximum DC Power	5000			W
Input Voltage Range	40- 62			Vdc
Maximum Continuous Input Current	130			Adc
Battery Communication	CAN, RS485 (optional)			
ADDITIONAL FEATURES				
Supported Communication Interfaces	2 x RS485, Ethernet, Zigbee communications for Smart Energy (requires antenna) ⁽¹⁾ , Wi-Fi (requires antenna) ⁽²⁾ , Built-in GSM (optional)			
STANDARD COMPLIANCE				
Safety	IEC-62103 (EN50178), IEC-62109			
Grid Connection Standards ⁽²⁾	VDE 0126-1-1, VDE-AR-N-4105, AS-4777, G83 / G59			
Emissions	IEC61000-6-2, IEC61000-6-3, IEC61000-3-11, IEC61000-3-12			
RoHS	Yes			
INSTALLATION SPECIFICATIONS				
AC Output – Cable Gland Diameter	15 - 21			mm
Battery DC – Cable Gland Diameter	2 x 8-11			mm
PV DC Input	2 x MC4 pair			
Dimensions (HxWxD)	853 x 316 x 193			mm
Weight	37			kg
Operating Temperature Range	-40 - +60			°C
Cooling	Internal and external fans			
Noise	< 50			dB(A)

(1)Antenna kit for ZigBee/Wi-Fi communication should be purchased separately

(2)For all standards refer to Certifications category in Downloads page:

<http://www.solaredge.com/groups/support/downloads>

Protection Rating	IP65 — Outdoor and Indoor	
Mounting	Bracket provided	

Support Contact Information

If you have technical problems concerning SolarEdge products, please contact us:



<https://www.solaredge.com/service/support>

Before contact, make sure to have the following information at hand:

- Model and serial number of the product in question.
- The error indicated on the product SetApp mobile application or on the monitoring platform or by the LEDs, if there is such an indication.
- System configuration information, including the type and number of modules connected and the number and length of strings.
- The communication method to the SolarEdge server, if the site is connected.
- The product's software version as it appears in the status screen.

solaredge