



SHS 200 MPPT

Table of Contents

1. GENERAL DESCRIPTION	1
1.1. Solar home system	1
1.2. MPPT solar charger	1
1.3. Load output	1
1.4. PAYG enabled	1
1.5. Smart battery management	1
1.6. LCD screen	1
1.7. Battery box	1
2. IMPORTANT USAGE INSTRUCTIONS	2
3. INSTALLATION AND OPERATION INSTRUCTIONS	3
3.1. General	3
3.2. Installation sequence	3
3.3. Battery	3
3.3.1. General instruction	3
3.3.2. Battery box	3
4. Solar panels	5
4.1. General instruction	5
4.2. PV connection	5
4.2.1. Model with barrel PV connectors	6
4.2.2. Model with MC4 PV connectors	7
4.3. Sizing examples	7
5. Operating and storage conditions	8
6. USER INTERFACE GUIDE	9
6.1. Keypad layout	9
6.2. Menu map	9
7. PAYGO FUNCTIONALITY	10
7.1. General	10
7.2. OpenPaygo token	10
7.3. Compatible platforms	10
7.4. Activation process	10
8. TECHNICIAN INTERFACE GUIDE	11
8.1. Diagnostic menu	11
8.1.1. Description	11
8.1.2. Accessing the diagnostic menu	11
8.1.3. Diagnostic menu map	11
8.1.4. View hardware and software version	11
8.2. Setup menu	11
8.2.1. Description	11
8.2.2. Accessing the Setup menu	12
8.2.3. Setup Menu map	12
9. TROUBLESHOOTING	14
9.1. Error message	14
9.1.1. Alerts:	14
9.1.2. Warnings:	14
9.2. Device not active	14
9.3. Low battery	14
9.4. Solar panel level always low	15
10. SPECIFICATIONS	16

11. Enclosure Dimensions	18
11.1. SHS 200 MPPT	18
11.2. Battery Box SHS 200	19

1. GENERAL DESCRIPTION

1.1. Solar home system

The SHS 200 is a smart solar charge controller and power distribution system designed for off-grid electricity access. It is used with solar panels and a battery to power DC appliances (12V).

1.2. MPPT solar charger

By using Maximum Power Point Tracking (MPPT) technology, the SHS 200 ensures that every drop of available power is harvested. Especially in case of a clouded sky, when light intensity is changing continuously, a fast MPPT algorithm will improve energy harvest by up to 30% compared to PWM charge controllers.

1.3. Load output

The SHS 200 offers ten USB ports for charging of phones and other USB appliances (tablets, hair clippers, radios, etc.) as well as five DC ports for the operations of lamps or other 12V appliances (TV, alarms, small fridge, etc.).

1.4. PAYG enabled

The SHS 200 features a keypad for low-cost and reliable offline pay-as-you-go activation. It is equipped with the [OpenPAYGO Token](#) technology - an agnostic PAYGo algorithm which allows distributors to work with their preferred PAYGo platforms (e.g. PaygOps, Paygee, Angaza) - or even their own proprietary platform.

1.5. Smart battery management

Smart multi-stage charging and load disconnect features maintain the health and extends the life of the battery. Internal temperature sensor to compensate charge voltage according to temperature. The SHS 200 is compatible with lead-acid and lithium battery technologies.

1.6. LCD screen

The LCD screen Display parameters such as usage statistics, battery state of charge and agent diagnostics. Easy navigation and adjustable languages (English, French, Swahili).

1.7. Battery box

Optional anti-tampering enclosure to prevent direct connections on battery terminals.

2. IMPORTANT USAGE INSTRUCTIONS

SAVE THESE INSTRUCTIONS - This manual contains important instructions that shall be followed during installation and maintenance.



The danger of explosion from sparking.

The danger of electric shock.

- It is advised to read this manual carefully before the product is installed and put into use.
- This product is designed and tested in accordance with international standards. It should be used for the designated application only.
- Install the product in a heatproof environment. Ensure therefore that there are no chemicals, plastic parts, curtains or other textiles, etc. in the immediate vicinity of the equipment.
- Ensure that the equipment is used under the correct operating conditions. Never operate it in a wet environment.
- Never use the product at sites where gas or dust explosions could occur.
- Ensure that there is always sufficient free space around the product for ventilation. The product and battery should be kept from direct sunlight exposure. These components should be kept in a shaded and cool area. They are intended for indoor use only.
- Refer to the specifications provided by the manufacturer of the battery to ensure that the battery is suitable for use with this product. The battery manufacturer's safety instructions should always be observed.
- Protect the solar panels from incident light during installation, e.g. cover them.
- Never touch uninsulated cable ends. Use only insulated tools.
- The installer of the product must provide a means for cable strain relief to prevent the transmission of stress to the connections. Make sure the connectors used for the solar panel and appliances have sufficient ratings and do not generate excess heat.
- In addition to this manual, the system operation or service manual must include a battery maintenance manual applicable to the type of batteries used.
- The device, battery, and solar panels should never be discarded into the environment.

3. INSTALLATION AND OPERATION INSTRUCTIONS

3.1. General

Mount vertically on a non-flammable substrate, with the USB terminals facing downwards. Observe a minimum clearance of 10 cm under and above the product for optimal cooling.

If using the device with solar power above 100Wp, the device must be installed vertically using the wall mount. And extra care should be taken so that its installation location is shaded and well ventilated.

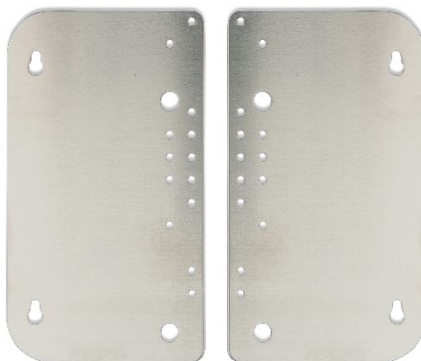

Figure 1 Wall mount (included with the SHS 200)

Mount close to the battery, but never directly above the battery (to prevent damage due to gassing of the battery).

3.2. Installation sequence

The installation of the SHS 200 must be done in the following sequence:

- connect the battery (preferably fully charged)
- connect the solar array (pay specific attention to avoid reverse polarity)
- configure displayed language (see paragraph Setup menu)
- configure battery and solar PV size (see paragraph Setup menu)
- connect the loads

3.3. Battery

3.3.1. General instruction

The SHS is designed for use with a 12V / 6 cells sealed lead-acid battery with a capacity of up to 160Ah. It includes two cables (negative and positive) of 1m (14AWg) with M6 terminals to connect the battery.

Voltage: 12V nominal, real voltage in the range of 9VDC-15VDC during use.

Current: Charge up to 14A. Discharge up to 20A. This is subject to the actual battery used and its size (the current may be limited to reduce battery aging and ensure safety – see paragraph Setup menu).

3.3.2. Battery box

An optional battery box is available from Victron Energy to protect the battery from tampering attempts. Please refer to the SHS battery box quick installation guide and drawings for additional details.

Battery Box SHS 200	
Material	Aluminum
Protection category	IP 21
Internal dimensions (H x W x D)	250 x 350 x 195mm



4. Solar panels

4.1. General instruction

The solar panel should be put in direct sunlight, absolutely no part of it should be shaded, even partially. Ensure the panel is placed in a location where no shading will occur at any time during the day.

The solar panel should be cleaned regularly; the dust can have a significant impact on performance. It can be cleaned using a wet cloth or sponge.

The controller will operate only if the PV voltage exceeds the battery voltage (V_{bat}).

- PV voltage must exceed $V_{bat} + 2V$ for the controller to start.
- Maximum open circuit PV voltage: 24V

All panels connected on the SHS 200 must be identical with the exact same specifications.

4.2. PV connection

The SHS 200 exists in two different versions: barrel and MC4 connectors. The difference stands in the connectors used to plug PV panels. The SHS with barrel connectors is easier to install and more suitable for smaller PV arrays. The SHS with MC4 connectors enables to use of a larger range of PV panels which is useful for more powerful configurations.

	Barrel connectors	MC4 connectors
Advantage	Easy plug-and-play PV connections.	Flexible choice of PV panels
Inconvenient	Limited combinations of PV panels.	Require additional wiring know-how.

Possible PV panels combinations:

	36-cells panels in parallel*			
SHS 200 models	(20 to 50 Wp)	(55 to 65 Wp)	(70 to 100 Wp)	(105 to 200 Wp)
Barrel connectors	1 to 4	n/a	n/a	n/a
MC4 connectors	1 to 4	1 to 3	1 or 2	1

*No series connection allowed

4.2.1. Model with barrel PV connectors

The product includes 4 PV inputs (5.5mmx2.1mm barrel connectors). Each input can be connected to one solar panel comprising of 36 cells in series ("12V panel") and with a maximum short-circuit current (I_{sc}) of 5A. The overall total peak power installed on the SHS must not exceed 200Wp (watts peak).

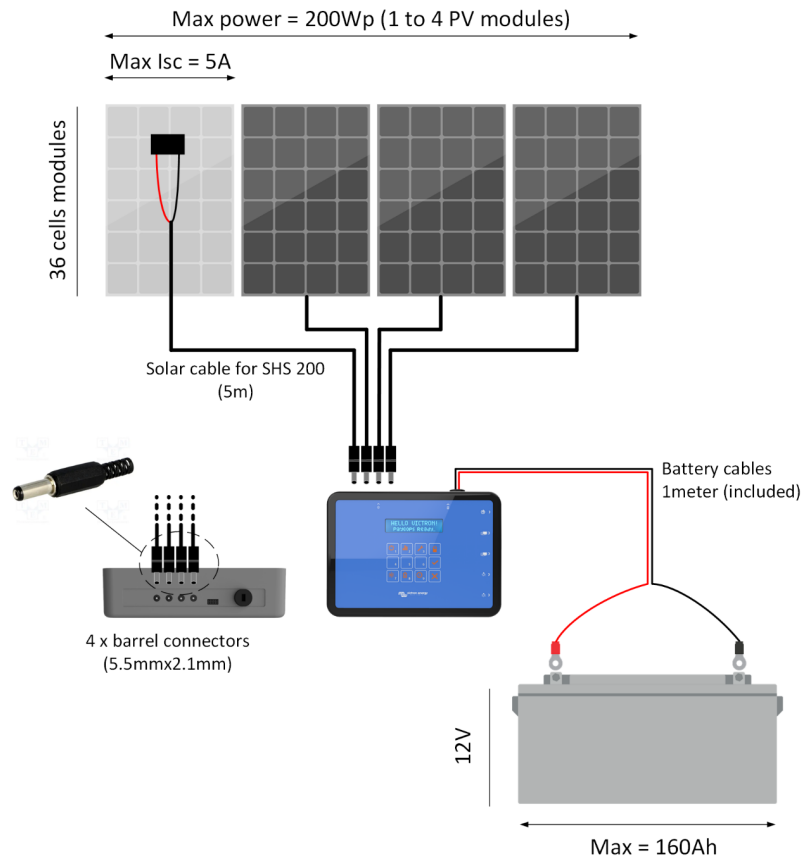

4.2.2. Model with MC4 PV connectors

The product includes a positive and a negative extension cable (25 cm length - 14 AWG section). The negative cable is terminated by a female MC4 connector. The positive cable is terminated by a male MC4 connector. It allows a correct connection with PV modules that generally have the female MC4 connector on the positive cable (male on the negative). Any combination of 36-cells panels connected in parallel with an overall total peak power of 200Wp (watts peak) or less can be installed on the PV terminals (e.g., 2 x 90Wp, 1 x 200Wp). It is recommended to use MC4 splitter connectors (also called Y or W connectors) to connect panels in parallel.

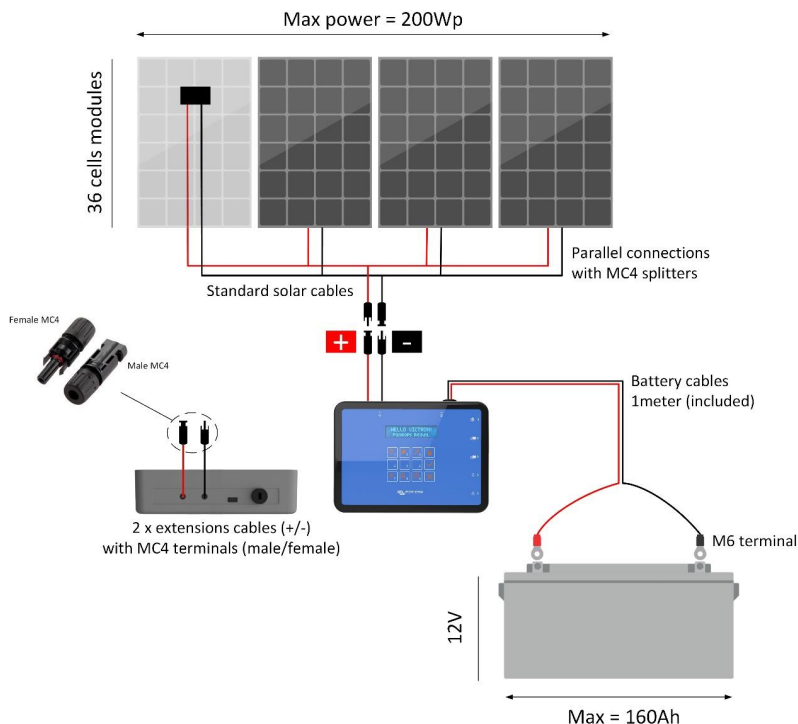

4.3. Sizing examples

The table below gives some examples of suitable PV panels and battery combinations for the SHS 200. Daily energy production is calculated for an average daily irradiation of 5000Wh/m²/d. Local conditions (solar irradiations and temperature) should be considered for proper system sizing. Lower solar irradiations result in bigger PV power and battery capacity requirements to supply the same energy demand. Higher temperatures result in lower PV panels efficiency.

Configuration #	PV power Wp	Daily production [1] Wh/day	Battery voltage V	Recommended battery	
				Capacity Ah @12V	Autonomy [2] Wh
SHS 200 #1	50	200	12	30	180
SHS 200 #2	100	400	12	60	360
SHS 200 #3	150	600	12	90	540
SHS 200 #4	200	800	12	120	720



- [1] Daily energy available with an average solar irradiation of 5000 kWh/m²/d, and an average system efficiency of 80%.
- [2] Net storage autonomy with a maximum depth of discharge at 50%.

5. Operating and storage conditions









- Operating Temperature: 5°C-35°C
- Storage Temperature: 0°C-45°C.
- Relative humidity: 0% to 90% non-condensing.
- Operating Altitude: up to 3000m
- Storage Altitude: up to 6000m

6. USER INTERFACE GUIDE

6.1. Keypad layout



6.2. Menu map

	Check the status of the USB ports.
	Check the status of the 12V port.
	WRENCH. Goes to the Service menu. It should only be used by technicians.
	LOCK. Goes to the activation menu.
	CHECK.
	Shows the level of illumination of the panel. This is not an absolute value but mainly a relative indicator to help find the optimal position.
	Shows an approximation of the state of charge of the battery (in %).
	Displays the number of days left in the device before activation expires. If the device is fully activated, it is shown as such.

7. PAYGO FUNCTIONALLITY

7.1. General

The SHS 200 is a pay-as-you-go (PAYGo) enabled device. It allows end-users to digitally pay for energy through a pre-paid "rent-to-own" model.

1. The end-user pays energy to their distributors for a definite period of time (e.g. 30 days);
2. An activation token is sent by SMS to the end-user;
3. The end-user enters the activation token on the keypad of the SHS;
4. The SHS is unlocked (active DC outputs) and can be used until time credited is spent.

Payments are usually done by mobile money or cash transfer to avoid cash collection and to allow automated processing. A PAYGo software platform enables distributors to generate and send activation tokens according to customer payments.

It is also possible to use the SHS 200 without the PAYGo function. The device is simply active forever and does not require any token to be unlocked.

7.2. OpenPaygo token

The SHS 200 runs with the *OpenPAYGO token*. It is an open-source token system which can be integrated with any PAYGo software platform.

More information: <https://enaccess.org/materials/openpaygotoken/>

7.3. Compatible platforms

The SHS 200 is already integrated with the following commercially available PAYGo platforms:

- Angaza: <https://www.angaza.com/>
- PaygOps: <https://www.paygops.com/>
- Paygee: <https://paygee.com/>

7.4. Activation process

The activation menu is used to add time credit to the SHS. If the device is fully activated this menu is not useful. If the device is not activated (time is 0) the screen displays "Not Active". The device can be activated with the following procedure:

1. Access the activation menu by pressing the LOCK button.
2. Enter the activation token provided by the PAYGo platform.
3. Press CHECK to validate. It should now show the number of days added.

Press LOCK again to return to the main menu.

8. TECHNICIAN INTERFACE GUIDE

8.1. Diagnostic menu

8.1.1. Description

The diagnostic menu gives the state of all sensors in the device to ease monitoring and diagnostic.

8.1.2. Accessing the diagnostic menu

Procedure from the Main menu:

1. Press and hold key 3 (WRENCH). It should say "Service Menu".
2. Press 567415 in that order, without pressing anything else.
3. If the procedure is successful, it should say "Diagnostic or (LOCK) for Setup".
4. In case of error, press CANCEL to return to the main menu and repeat the procedure.

Press CANCEL to go back to the main menu.

Press CHECK to view the hardware and firmware versions of the device.

8.1.3. Diagnostic menu map

Once it says "Diagnostic or (LOCK) for Setup", diagnostic parameters are accessible by pressing keys from 1 to 9:

Key	Parameter	Description
1	USB ports	Press keys from 1 to 10 to see the current measured at each port.
2	12V DC ports	Current measured at the 5 DC ports.
3	Charging	Voltage and currents of the solar panels (*) and the battery (■)
4	Keypad	Type something into keypad to test.
5	Usage statistics	Statistics about device usage. Press any number key to go to the next stat. Press CANCEL to go back to the Diagnostic menu.
6	LCD diagnostic	Test characters on the LCD and characters used for the code.
7	Core clock	Core clock frequency (72MHz).
8	Temperature Sensor	Internal temperature of the device.
9	RTC	Internal clock raw time.

8.1.4. View hardware and software version

Procedure from the Main menu:

1. Press and hold key 3 (wrench). It should say "Service Menu".
2. Press 567415 in that order, without pressing anything else.
3. If the procedure is successful, it should say "Diagnostic or (lock) for Setup".
4. Press WRENCH to view the hardware and software version of the unit.
5. In case of error, press the X key to return to the main menu, and repeat the procedure.

Press CANCEL to go back to the main menu.

8.2. Setup menu

8.2.1. Description

The setup menu can be used to change some parameters of the device. Most parameters should be left default, apart from the battery and panel size that should be specified. The other parameters can be adjusted to ease troubleshooting or to provide a temporary fix to a particular issue.

8.2.2. Accessing the Setup menu

Procedure from the Main menu:

1. Press and hold key 3 (wrench). It should say "Service Menu".
2. Press 567415 in that order, without pressing anything else.
3. If the procedure is successful, it should say "Diagnostic or (lock) for Setup".
4. Press LOCK to enter the setup menu.
5. In case of error, press the X key to return to the main menu, and repeat the procedure.

Press CANCEL to go back to the main menu.

8.2.3. Setup Menu map

Procedure from the Setup menu:

- Press LOCK twice to reset the device to factory settings. To confirm press 1: Yes.
- Press key 1 to 9 to access the different settings (see table below). Press LOCK to change the selected setting. Press CANCEL to go back to the Setup menu.
- Press CANCEL to go back to the Diagnostic menu.

Settings:

Key	Setting	Description
1	Language selection menu	Selection: 1. English, 2. French, 3. Swahili
2	Panel Size Setting	Allows to enter the panel size (in W)
3	Battery Size Setting	Allows to enter the battery size (in Ah) Warning: make sure to check with the battery manufacturer that the selected settings are adequate.
4	Voltages setting	Press key 1 to access Float voltage. Press CHECK to accept. Press one of the following keys to choose the voltage: 1: 13.0V, 2: 13.4V, 3: 13.7V, 4: 13.9V, 0: 13.75V (default). Press key 2 to access Absorption voltage. Press CHECK to accept. Press one of the following keys to choose the voltage: 1: 13.8V, 2: 14.0V, 3: 14.25V, 4: 14.5V, 5: 14.75V, 6: 15.0V, 0: 14.4V (default) Press key 3 to access Low battery disconnect. Press CHECK to accept. Press one of the following keys to choose the voltage: 1: 10.0V, 2: 11.5V, 3: 12.0V, 0: 11.25 (default) The DC outputs of the SHS are switched off when the low voltage disconnect is reached to prevent deep discharge of the battery.
5	Backup light (load shed)	To set the backup light (load shed) minimum SoC 1: 15%, 2: 25%, 3: 35%, 4: 45%
6	Special menu	Changing the settings on this menu will void the warranty.
7	Sensor calibration	To automatically recalibrate the ADC and the current sensors (for the USB and 12V outputs)
8	Battery Internal Resistance	To define the internal resistance of the battery (default 15mOhm)
9	Battery Maximum Depth of Discharge	Default is 50%. This parameter defines the usable capacity of the battery as a percentage of the total capacity of the battery. The recommended setting for lead-acid batteries is 50%. At this setting, only 50% of the battery capacity will be usable, but this limit should allow a drastic increase in the life of the battery (typically 3 times the duration compared to 100% DoD).

In the Special menu* there are different Sub-Menus that are accessible by pressing the corresponding key:

1	USB ports protection	to enable/disable the overcurrent protection on USB ports.
---	----------------------	--

2	DC12 ports protection	to enable/disable the overcurrent protection on DC12 ports 1: enable the protection; 2: disable the protection
---	-----------------------	---

*Changing the settings on this menu will void the warranty.

9. TROUBLESHOOTING

9.1. Error message

Below is an explanation of the reasons why a particular error message would be shown on the device screen. *Alerts* are critical issues, the device will try to auto-protect but the source of the issue should be removed before continuing using the device. *Warnings* are less serious but can still require action to fix them.

9.1.1. Alerts:

Over Temperature (FR: Surchauffe):

- Using the SHS 200 in an overly hot place
- Using the SHS 200 directly exposed to sunlight
- Using the SHS 200 in a place with inadequate ventilation.

Battery Overvoltage (FR: SurVoltage Bat.):

- Connecting the solar panel (or another power source) on DC output port
- Using an incorrect battery type (for example a 12 cells battery instead of a 6 cells)
- Using a battery that has been overcharged before

Battery Overcurrent (FR: SurCourant Bat.):

- Using too many appliances drawing too much power at the same time (more than safe for use with the selected battery).
- Connecting the solar panel (or another power source) to the DC output port

USB Overcurrent (FR: SurCourant USB):

- Using USB appliances that exceeds the maximum current supported by the port.

DC12 Overcurrent (FR: SurCourant DC12):

- Using DC appliances that exceeds the maximum current supported by the port.

9.1.2. Warnings:

Panel OverVoltage (FR: SurVoltage Pan.):

- Using a solar panel that is inadequate for use with the SHS 200 (for example a 60 cells solar panel instead of 36 cells)
- Using a power source that is not a solar panel and that has a voltage that is too high
- Using an approved solar panel, but in a situation with very low outside temperature (close to 0 degrees Celsius) can cause the panel to produce an overly high voltage.

Battery UnderVoltage (FR: SousVoltage Bat.):

- Using an overly discharged battery (well below the low battery cut voltage)
- Using an incorrect battery type (for example with 2 cells instead of 6 cells)

9.2. Device not active

If the device is showing "Not Active, Please Activate", it means that the device should be activated. To do so press the (LOCK) key to access the Activation Menu and follow the procedure described in the section Activation process.

9.3. Low battery

If the device screen shows "Low Bat." and the USB ports and lights are turned OFF, it means that the battery is discharged, and the device is preventing further use of it to avoid damages.

This can happen in case of overuse or in case of low amount of incoming solar power (cloudy weather or poorly positioned solar panel). Check that the solar panel is positioned in full sun and allow the battery to charge without using the device for a couple of daylight hours and then use it as little as possible until the battery reaches a high state of charge (over 80% after the charge is finished at night).

Do not in any case try to connect anything directly to the battery to bypass that protection as it will permanently damage the battery.

If the weather is good and the usage is low, the problem might come from the solar panel, in that case, refer to the section below for further information on how to solve the problem.

9.4. Solar panel level always low

If the solar panel indicator is low (below 40%) even when there is a lot of sun shining on the solar panels or if the battery never reaches a high level of charge, there might be an issue with the solar panel positioning or cleanliness.

First, check if the solar panel is cleaned. A thin layer of dust or a small (even just 1 cm wide) piece of dirt or leaves on the panel can significantly impact its performance. Use a wet cloth to clean the panel thoroughly.

Second, make sure that no part of the solar panel is in the shade, a small shadow on any part of the solar panel can reduce its production a lot. Make sure that no tree, branch or construction will make a shadow on the solar panel at any time of the day.

10. SPECIFICATIONS

SHS 200 MPPT		
Battery voltage	12Vdc	
Nominal PV power	Up to 200Wp total (36 cells panels)	
Maximum charge / discharge currents	14A / 20A	
Peak efficiency	96%	
Suitable battery capacity	Up to 160Ah	
Compatible battery technologies	Sealed lead-acid, lithium.	
Absorption / float voltages	14.4V / 13.75V (configurable)	
Temperature compensation	Yes (automatic)	
Automatic load disconnect	Yes (configurable low state of charge disconnect)	
Operating temperatures	0 to 40°C (derating from 35°C)	
Humidity	90%, non-condensing	
Protections	Battery reverse polarity, battery overvoltage, battery undervoltage, battery overcurrent, load outputs overcurrent.	
PAYGo		
Remote activation	Unlock tokens sent to end-user via SMS to activate the system	
Compatible PAYGo platforms	PaygOps, Angaza, Paygee	
Token technology	Free and secure open-source token system (OpenPAYGO)	
ENCLOSURE		
PV terminals	Barrel model 4 x 5.5mmx2.1mm barrel connectors with an individual current limit of 5A	MC4 model A positive and a negative extension PV cable (1 meter - 14 AWG) terminated with MC4 connector.
Battery cables	Included (14 AWG - 1m) / suitable for M6 battery terminals	
USB outputs	10 USB ports (type A) Voltage: 4.75V-5.25V Overall maximum of 10A across all ports Individual maximum of 1.5A per port Compliant with the USB Battery Charging 1.2 standard	

SHS 200 MPPT	
Standard 12V DC outputs	<p>Voltage: 10.5 to 15V (according to Lighting Global standard) Protection: software overcurrent protection and resettable fuse</p> <p>Port 1 and 2 (from bottom):</p> <ul style="list-style-type: none"> • Current: Up to 3A • Connector: 5.5mm x 2.1mm barrel connector <p>Port 3 and 4:</p> <ul style="list-style-type: none"> • Current: Up to 5A • Connector: 5.5mm x 2.1mm barrel connector <p>Port 5:</p> <ul style="list-style-type: none"> • Current: Up to 10A • Connector: 5.08mm pin space pluggable screw terminal
Operating temperatures	0 to 40°C (derating from 35°C)
Color	<p>Standard: black enclosure and blue keypad</p> <p>Customizable co-branding (minimum order quantity: 1000 units)</p>
Dimensions (h x w x d)	148 x 204 x 67 mm
Net weight	0.39kg
Protection category	IP 41

11. Enclosure Dimensions

11.1. SHS 200 MPPT

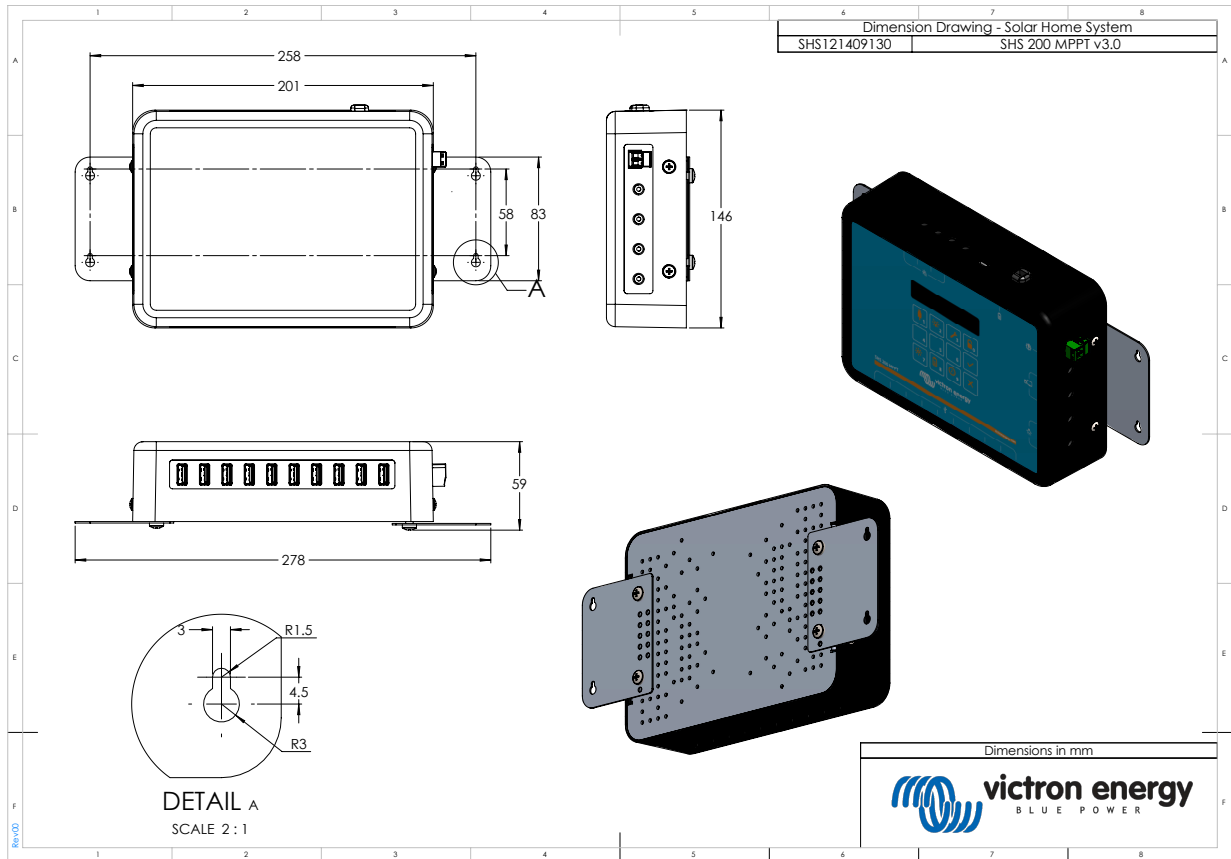

11.2. Battery Box SHS 200

