



## SUNNY TRIPOWER X 12 / 15 / 20 / 25

## Legal Provisions

The information contained in these documents is the property of SMA Solar Technology AG. No part of this document may be reproduced, stored in a retrieval system, or transmitted, in any form or by any means, be it electronic, mechanical, photographic, magnetic or otherwise, without the prior written permission of SMA Solar Technology AG. Internal reproduction used solely for the purpose of product evaluation or other proper use is allowed and does not require prior approval.

SMA Solar Technology AG makes no representations or warranties, express or implied, with respect to this documentation or any of the equipment and/or software it may describe, including (with no limitation) any implied warranties of utility, merchantability, or fitness for any particular purpose. All such representations or warranties are expressly disclaimed. Neither SMA Solar Technology AG nor its distributors or dealers shall be liable for any indirect, incidental, or consequential damages under any circumstances.

The exclusion of implied warranties may not apply in all cases under some statutes, and thus the above exclusion may not apply.

Passwords managed by this SMA product are always stored encrypted.

Specifications are subject to change without notice. Every attempt has been made to make this document complete, accurate and up-to-date. Readers are cautioned, however, that product improvements and field usage experience may cause SMA Solar Technology AG to make changes to these specifications without advance notice or per contract provisions. SMA Solar Technology AG shall not be responsible for any damages, including indirect, incidental or consequential damages, caused by reliance on the material presented, including, but not limited to, omissions, typographical errors, arithmetical errors or listing errors in the content material.

### SMA Warranty

You can download the current warranty conditions from the Internet at [www.SMA-Solar.com](http://www.SMA-Solar.com).

### Software licenses

The licenses for the installed software modules (open source) can be found in the user interface of the product.

### Trademarks

All trademarks are recognized, even if not explicitly identified as such. Missing designations do not mean that a product or brand is not a registered trademark.

### SMA Solar Technology AG

Sonnenallee 1

34266 Niestetal

Germany

Tel. +49 561 9522-0

Fax +49 561 9522-100

[www.SMA.de](http://www.SMA.de)

E-mail: [info@SMA.de](mailto:info@SMA.de)

Status: 2/28/2024

Copyright © 2024 SMA Solar Technology AG. All rights reserved.

# Table of contents

<b>1</b>	<b>Information on this Document.....</b>	<b>9</b>
1.1	Validity .....	9
1.2	Target Group.....	9
1.3	Content and Structure of this Document .....	9
1.4	Levels of Warning Messages .....	9
1.5	Symbols in the Document .....	10
1.6	Typographies in the document .....	10
1.7	Designations in the Document .....	10
1.8	Additional Information .....	11
<b>2</b>	<b>Safety .....</b>	<b>12</b>
2.1	Intended Use .....	12
2.2	IMPORTANT SAFETY INSTRUCTIONS.....	13
<b>3</b>	<b>Scope of Delivery .....</b>	<b>18</b>
<b>4</b>	<b>Product Overview .....</b>	<b>20</b>
4.1	Device function.....	20
4.2	System overview.....	20
4.2.1	Sunny Tripower X as system manager.....	20
4.2.2	Sunny Tripower X with Sunny Home Manager .....	21
4.2.3	Sunny Tripower X with SMA Data Manager as System Manager .....	21
4.3	Product Description .....	22
4.4	Symbols on the Product .....	22
4.5	Interfaces and Functions .....	24
4.5.1	User Interface.....	24
4.5.2	Device Key (DEV KEY) .....	24
4.5.3	Diagnostic function .....	25
4.5.4	Digital inputs .....	25
4.5.5	Integrated Plant Control .....	25
4.5.6	Modbus .....	25
4.5.7	Multifunction relay (MFR).....	25
4.5.8	Grid Management Services.....	26
4.5.9	Fast stop function .....	26
4.5.10	SMA ArcFix.....	26
4.5.11	SMA Dynamic Power Control.....	26
4.5.12	SMA ShadeFix.....	27
4.5.13	SMA Smart Connected .....	27
4.5.14	SMA Speedwire .....	27
4.5.15	Surge arrester type 1+2 or type 2 .....	27
4.5.16	Wi-Fi.....	27

4.5.17	Wi-Fi connection to SMA 360° app and SMA Energy app.....	28
4.6	LED Signals.....	28
<b>5</b>	<b>Mounting .....</b>	<b>30</b>
5.1	Requirements for Mounting .....	30
5.1.1	Requirements for the Mounting Location.....	30
5.1.2	Permitted and prohibited mounting positions.....	30
5.1.3	Dimensions for mounting.....	31
5.1.4	Recommended clearances for mounting.....	31
5.2	Mount the product. ....	32
5.3	Mount the DC terminal cover (optional).....	34
<b>6</b>	<b>Electrical Connection.....</b>	<b>36</b>
6.1	Requirements for the electrical connection .....	36
6.1.1	Permitted grid configurations .....	36
6.1.2	Residual-current monitoring unit.....	36
6.1.3	Load-break switch and cable protection .....	37
6.1.4	Additional grounding .....	37
6.1.5	Equipotential Bonding .....	38
6.1.6	Overvoltage category .....	38
6.1.7	AC cable requirements.....	38
6.1.8	Network cable requirements.....	38
6.1.9	Requirements for the PV modules per input.....	39
6.1.10	DC cable requirements.....	39
6.1.11	Signal cable requirements.....	39
6.2	Overview of the Connection Area .....	40
6.2.1	View from Below.....	40
6.2.2	Interior View .....	41
6.3	Electrical connection procedure .....	41
6.4	Connecting the AC Cable .....	42
6.5	Connecting Additional Grounding.....	44
6.6	Connecting the Network Cables.....	45
6.7	Connection of a Ripple Control Receiver .....	46
6.7.1	Digital input DI 1-4 .....	46
6.7.2	Pin assignment DI 1-4.....	47
6.7.3	Circuitry overview DI 1-4 .....	47
6.7.4	Connecting the ripple control receiver to DI 1-4 .....	47
6.8	Connection to the Multifunction Relay.....	49
6.8.1	Digital output (MFR) .....	49
6.8.2	Pin assignment MFR.....	49
6.8.3	Connect signal source to MFR.....	49
6.9	Connection to digital input DI 5-6.....	50
6.9.1	Digital input DI 5-6 .....	50
6.9.2	Pin assignment DI 5-6.....	50

6.9.3	Circuitry overview DI 5 .....	51
6.9.4	Circuitry overview DI 6 .....	51
6.9.5	Connecting Signal Source to Digital Input DI 5-6 .....	51
6.10	DC connection .....	53
6.10.1	Overview of DC connectors .....	53
6.10.2	Assembling the DC Connectors .....	53
6.10.3	Connecting the PV Array .....	55
<b>7</b>	<b>Commissioning .....</b>	<b>58</b>
7.1	Procedure for commissioning as a subordinate device .....	58
7.2	Procedure for commissioning as System Manager .....	58
7.3	Commissioning the Product .....	60
<b>8</b>	<b>Operation .....</b>	<b>61</b>
8.1	Establishing a connection to the user interface .....	61
8.1.1	Connection in the local network .....	61
8.1.1.1	Access addresses for the product in the local network.....	61
8.1.1.2	Ports for data communication in the local network .....	61
8.1.1.3	Establishing a Connection via Ethernet in the local network .....	62
8.1.1.4	Establishing a Connection via WLAN in the Local Network .....	63
8.1.2	Direct connection via Wi-Fi .....	63
8.1.2.1	Connection options for Wi-Fi direct connection .....	63
8.1.2.2	Access information for direct Wi-Fi connection .....	64
8.1.2.3	Establishing a direct Wi-Fi connection with WPS .....	64
8.1.2.4	Establishing direct Wi-Fi connection with Wi-Fi network search .....	64
8.2	WPS function .....	65
8.2.1	Connection options with WPS .....	65
8.2.2	Activating WPS for automatic connection .....	65
8.2.3	Activating WPS for direct connection to a smart device .....	65
8.3	Design of the User Interface .....	66
8.4	Access rights to the user interface .....	67
8.5	Changing parameters .....	67
8.6	SMA ArcFix .....	67
8.7	Digital output (MFR) .....	68
8.7.1	Use of the digital output (MFR) .....	68
8.7.2	Configure the digital output (MFR) .....	69
8.8	Configure the digital input DI 5 for the fast stop .....	69
8.9	Configuring the digital input DI 1-4 for the external setpoint .....	70
8.10	Grid and PV system protection .....	71

8.11	Generating the I-V Characteristic Curve .....	71
8.12	Activating a Digital Product .....	71
8.13	Backup file .....	72
8.13.1	Function and content of the backup file .....	72
8.13.2	Creating a Backup File .....	72
8.14	Carry out a manual firmware update .....	73
8.15	Device Administration .....	73
8.15.1	Register Devices .....	73
8.15.2	Delete devices .....	73
8.16	Resetting the product to default setting .....	74
8.17	Deleting the Admin Account .....	74
<b>9</b>	<b>Disconnecting the Inverter from Voltage Sources .....</b>	<b>75</b>
<b>10</b>	<b>Cleaning .....</b>	<b>79</b>
<b>11</b>	<b>Troubleshooting .....</b>	<b>80</b>
11.1	Event messages .....	80
11.2	Calculating the insulation resistance .....	95
11.3	Checking the PV System for Ground Faults .....	96
11.4	Cleaning the Fans .....	97
11.5	Manual restart after electric arc .....	98
<b>12</b>	<b>Decommissioning the Product .....</b>	<b>99</b>
<b>13</b>	<b>Disposal .....</b>	<b>100</b>
<b>14</b>	<b>Technical Data .....</b>	<b>101</b>
14.1	General Data .....	101
14.2	DC Input .....	102
14.3	AC output .....	102
14.4	Digital inputs .....	104
14.5	Digital output (multifunction relay) .....	104
14.6	Communication .....	105
14.7	Data Storage Capacity .....	105
14.8	Efficiency .....	105
14.9	Protective Devices .....	105
14.10	Climatic Conditions .....	106
14.11	Equipment .....	106
14.12	Torques .....	106
<b>15</b>	<b>Accessories .....</b>	<b>107</b>

<b>16 Contact .....</b>	<b>108</b>
<b>17 EU Declaration of Conformity .....</b>	<b>109</b>
<b>18 UK Declaration of Conformity .....</b>	<b>110</b>



# 1 Information on this Document

## 1.1 Validity

This document is valid for:

- STP 12-50 (Sunny Tripower X 12) from firmware version 3.06.15.R
- STP 15-50 (Sunny Tripower X 15) from firmware version 3.06.15.R
- STP 20-50 (Sunny Tripower X 20) from firmware version 3.06.15.R
- STP 25-50 (Sunny Tripower X 25) from firmware version 3.06.15.R

## 1.2 Target Group

This document is intended for qualified persons and end users. Only qualified persons are allowed to perform the activities marked in this document with a warning symbol and the caption "Qualified person". Tasks that do not require any particular qualification are not marked and can also be performed by end users. Qualified persons must have the following skills:

- Knowledge of how to safely disconnect SMA inverters
- Knowledge of how an inverter works and is operated
- Training in how to deal with the dangers and risks associated with installing, repairing and using electrical devices and installations
- Training in the installation and commissioning of electrical devices and installations
- Knowledge of all applicable laws, regulations, standards, and directives
- Knowledge of and compliance with this document and all safety information

## 1.3 Content and Structure of this Document

This document describes the mounting, installation, commissioning, configuration, operation, troubleshooting and decommissioning of the product.

The latest version of this document and additional information about the product can be found in PDF format and as an eManual at [www.SMA-Solar.com](http://www.SMA-Solar.com). You can also call up the eManual via the user interface of the product.

Illustrations in this document are reduced to the essential information and may deviate from the real product.

## 1.4 Levels of Warning Messages

The following levels of warning messages may occur when handling the product.

### DANGER

Indicates a hazardous situation which, if not avoided, will result in death or serious injury.

### WARNING

Indicates a hazardous situation which, if not avoided, could result in death or serious injury.



**⚠ CAUTION**

Indicates a hazardous situation which, if not avoided, could result in minor or moderate injury.

**NOTICE**

Indicates a situation which, if not avoided, can result in property damage.

## 1.5 Symbols in the Document

Symbol	Explanation
	Information that is important for a specific topic or goal, but is not safety-relevant
<input type="checkbox"/>	Indicates a requirement for meeting a specific goal
<input checked="" type="checkbox"/>	Required result
	Example
<b>⚠ QUALIFIED PERSON</b>	Sections describing activities to be performed by qualified persons only

## 1.6 Typographies in the document

Typography	Use	Example
<b>bold</b>	<ul style="list-style-type: none"> <li>Messages</li> <li>Terminals</li> <li>Elements on a user interface</li> <li>Elements to be selected</li> <li>Elements to be entered</li> </ul>	<ul style="list-style-type: none"> <li>Connect the insulated conductors to the terminals <b>X703:1</b> to <b>X703:6</b>.</li> <li>Enter <b>10</b> in the field <b>Minutes</b>.</li> </ul>
>	<ul style="list-style-type: none"> <li>Connects several elements to be selected</li> </ul>	<ul style="list-style-type: none"> <li>Select <b>Settings &gt; Date</b>.</li> </ul>
[Button] [Key]	<ul style="list-style-type: none"> <li>Button or key to be selected or pressed</li> </ul>	<ul style="list-style-type: none"> <li>Select <b>[Enter]</b>.</li> </ul>
#	<ul style="list-style-type: none"> <li>Placeholder for variable components (e.g., parameter names)</li> </ul>	<ul style="list-style-type: none"> <li>Parameter <b>WCtHz.Hz#</b></li> </ul>

## 1.7 Designations in the Document

Complete designation	Designation in this document
Sunny Tripower X	Inverter, product

## 1.8 Additional Information

Additional information is available at [www.SMA-Solar.com](http://www.SMA-Solar.com).

Title and information content	Type of information
"PUBLIC CYBER SECURITY - Guidelines for a Secure PV System Communication"	Technical Information
"SMA GRID GUARD 10.0 - Grid Management Services via Inverter and System Controller"	Technical Information
"Efficiency and Derating" Efficiency and derating behavior of the SMA inverters	Technical Information
"SUNNY TRIPOWER X 12 / 15 / 20 / 25 - System functionalities at a glance"	Technical Information
"Compatibility between common grid configurations and SMA inverters and SMA charging stations"	Technical Information
"Commissioning and configuration of reactive power control of systems in the low-voltage grid in accordance with VDE-AR-N-4105"	Technical Information
"Impedance at 175 Hz for PV Systems in France"	Technical Information
"Arc-fault circuit interrupter"	Technical Information
"Short-Circuit Currents"	Technical Information
"Parameters and Measured Values" Device-specific overview of all parameters and measured values and their setting options Information about the SMA Modbus registers	Technical Information
"SMA Modbus ®-interface - ennexOS" Information on the SMA Modbus interface	Technical Information
"SunSpec Modbus ®-interface - ennexOS" Information about the SunSpec Modbus interface and supported information models	Technical Information

## 2 Safety

### 2.1 Intended Use

The Sunny Tripower is a transformerless PV inverter with 3 MPP trackers that converts the direct current of the PV modules to grid-compliant three-phase current and feeds it into the utility grid.

The product is intended for use in residential and industrial environments.

The product complies with EN 62920 of class B, group 1.

The product is suitable for indoor and outdoor use.

If the product is operated with a medium-voltage transformer, the low-voltage side must be configured in a star formation and the neutral point grounded (for information about the requirements of the medium-voltage transformer, consult the technical information "Important Requirements for Medium-Voltage Transformers" under [www.SMA-Solar.com](http://www.SMA-Solar.com)).

The product must only be operated with PV modules of protection class II in accordance with IEC 61730, application class A. The PV modules must be compatible with this product.

The product is not equipped with an integrated transformer and therefore has no galvanic isolation. The product must not be operated with PV modules whose outputs are grounded. This can cause the product to be destroyed. The product may be operated with PV modules whose frame is grounded.

PV modules with a high capacity to ground must only be used if the coupling capacity of all PV modules does not exceed 6  $\mu\text{F}$ .

The product contains a product approved by Anatel under the number 09133-22-01318.

This product does not guarantee protection against harmful interference and must not cause harmful disturbances to a properly authorized system. You can find more information on the Anatel website: <https://www.gov.br/anatel/pt-br>.

All components must remain within their permitted operating ranges and their installation requirements at all times.

The products by SMA Solar Technology AG are not suitable for use in

- Medical devices, in particular products for supplying life-support systems and machines,
- Aircraft, the operation of aircraft, the supply of critical airport infrastructure and airport systems,
- Rail vehicles, the operation and supply of rail vehicles and their critical infrastructure.

The above list is not exhaustive. Contact us if you are unsure whether products by SMA Solar Technology AG are suitable for your application.

The product must only be used in countries for which it is approved or released by SMA Solar Technology AG and the grid operator.

Use SMA products only in accordance with the information provided in the enclosed documentation and with the locally applicable laws, regulations, standards and directives. Any other application may cause personal injury or property damage.

Alterations to SMA products, e.g., changes or modifications, are only permitted with the express written permission of and according to the instructions from SMA Solar Technology AG. Unauthorized alterations can be dangerous and lead to personal injury. In addition, an unauthorized alteration will void guarantee and warranty claims and in most cases terminate the operating license. SMA Solar Technology AG shall not be held liable for any damage caused by such changes.

Any use other than that described in the Intended Use section does not qualify as appropriate. The documentation supplied is an integral part of SMA products. Keep the documentation in a convenient, dry place for future reference and observe all instructions contained therein.

This document does not replace any regional, state, provincial, federal or national laws, regulations or standards that apply to the installation, electrical safety and use of the product. SMA Solar Technology AG assumes no responsibility for the compliance or non-compliance with such laws or codes in connection with the installation of the product.

The type label must remain permanently attached to the product.

## 2.2 IMPORTANT SAFETY INSTRUCTIONS

Keep the manual for future reference.

This section contains safety information that must be observed at all times when working.

The product has been designed and tested in accordance with international safety requirements. As with all electrical or electronic devices, some residual risks remain despite careful construction. To prevent personal injury and property damage and to ensure long-term operation of the product, read this section carefully and observe all safety information at all times.

### DANGER

#### **Danger to life due to electric shock when live components or DC cables are touched**

When exposed to light, the PV modules generate high DC voltage which is present in the DC cables. Touching live DC cables results in death or lethal injuries due to electric shock.

- Do not touch non-insulated parts or cables.
- Disconnect the product from voltage sources and ensure it cannot be reconnected before working on the device.
- Do not disconnect the DC connectors under load.
- Wear suitable personal protective equipment for all work on the product.

### DANGER

#### **Danger to life due to electric shock from touching an ungrounded PV module or array frame**

Touching ungrounded PV modules or array frames results in death or lethal injuries due to electric shock.

- Connect and ground the frame of the PV modules, the array frame and the electrically conductive surfaces so that there is continuous conduction. Observe the applicable local regulations.

**⚠ DANGER****Danger to life due to electric shock when touching live system components in case of a ground fault**

If a ground fault occurs, parts of the system may still be live. Touching live parts and cables results in death or lethal injuries due to electric shock.

- Disconnect the product from voltage sources and ensure it cannot be reconnected before working on the device.
- Only touch the cables of the PV modules on their insulation.
- Do not touch any parts of the substructure or frame of the PV array.
- Do not connect PV strings with ground faults to the inverter.

**⚠ DANGER****Danger to life due to electric shock in case of overvoltages and if surge protection is missing**

Overvoltages (e. g. in the event of a flash of lightning) can be further conducted into the building and to other connected devices in the same network via the network cables or other data cables if there is no surge protection. Touching live parts and cables results in death or lethal injuries due to electric shock.

- Ensure that all devices in the same network are integrated in the existing overvoltage protection.
- When laying the network cable outdoors, ensure that there is suitable surge protection at the network cable transition from the product outdoors to the network inside the building.
- The Ethernet interface of the product is classified as "TNV-1" and offers protection against overvoltages of up to 1.5 kV.

**⚠ WARNING****Danger to life due to fire and deflagration**

In rare cases, an explosive gas mixture can be generated inside the product under fault conditions. In this state, switching operations can cause a fire and, in very rare cases, a deflagration inside the product. Death or lethal injuries due to the spread of a fire can result.

- In the event of a fault, do not perform any direct actions on the product.
- In the event of a fault, ensure that unauthorized persons have no access to the product.
- In case of failure, disconnect the PV module via an external disconnection device. If there is no disconnection device present, wait until no more DC power is applied to the inverter.
- In the event of a fault, disconnect the AC circuit breaker, or keep it disconnected in case it has already tripped, and secure it against reconnection.

**⚠ WARNING****Risk of injury due to toxic substances, gases and dusts.**

In rare cases, damages to electronic components can result in the formation of toxic substances, gases or dusts inside the product. Touching toxic substances and inhaling toxic gases and dusts can cause skin irritation, burns or poisoning, trouble breathing and nausea.

- Only perform work on the product (e.g., troubleshooting, repair work) when wearing personal protective equipment for handling of hazardous substances (e.g., safety gloves, eye and face protection, respiratory protection).
- Ensure that unauthorized persons have no access to the product.

**⚠ WARNING****Danger to life due to electric shock from destruction of the measuring device due to overvoltage**

Overvoltage can damage a measuring device and result in voltage being present in the enclosure of the measuring device. Touching the live enclosure of the measuring device results in death or lethal injuries due to electric shock.

- Only use measuring devices with a DC input voltage range of 1000 V or higher.

**⚠ CAUTION****Risk of burns due to hot enclosure parts**

The enclosure and the enclosure lid may get hot during operation. The DC load-break switch can not become hot.

- Do not touch hot surfaces.
- Wait until the inverter has cooled down before touching the enclosure or enclosure lid.

**⚠ CAUTION****Risk of injury due to weight of product**

Injuries may result if the product is lifted incorrectly or dropped while being transported or mounted.

- Transport and lift the product carefully. Take the weight of the product into account.
- Use the carrying handles or hoist when transporting the product. To attach the hoist system, eye bolts must be screwed into the threads provided, which are located on the right and left of the product's mounting lugs.
- Wear suitable personal protective equipment for all work on the product.

**NOTICE****Damage to the enclosure seal in subfreezing conditions**

If you open the product when temperatures are below freezing, the enclosure seals can be damaged. Moisture can penetrate the product and damage it.

- Only open the product if the ambient temperature is not below  $-5^{\circ}\text{C}$ .
- If a layer of ice has formed on the enclosure seal when temperatures are below freezing, remove it prior to opening the product (e.g. by melting the ice with warm air).

**NOTICE****Damage to the product due to sand, dust and moisture ingress**

Sand, dust and moisture penetration can damage the product and impair its functionality.

- Only open the product if the humidity is within the thresholds and the environment is free of sand and dust.
- Do not open the product during a dust storm or precipitation.
- Close tightly all enclosure openings.

**NOTICE****Damage to the inverter due to electrostatic discharge**

Touching electronic components can cause damage to or destroy the inverter through electrostatic discharge.

- Ground yourself before touching any component.

**NOTICE****Manipulation of system data in networks**

You can connect the supported SMA products to the Internet. When connected to the Internet, there is a risk that unauthorized users can access and manipulate the data of your system.

- Set up a firewall.
- Close unnecessary network ports.
- If absolutely necessary, only enable remote access via a virtual private network (VPN).
- Do not use the port forwarding feature. This also applies to the used Modbus ports.
- Disconnect system components from other network components (network segmentation).

**NOTICE****High costs due to inappropriate Internet tariff**

Depending on use, the data volume of the product transferred via the Internet may vary in size. The data volume depends, for example, on the number of devices in the system, the frequency of device updates, the frequency of data transfer to Sunny Portal or the use of FTP push. High costs for the Internet connection can be the result.

- SMA Solar Technology AG recommends using an Internet flat rate.



**NOTICE****Damage to the product due to cleaning agents**

The use of cleaning agents may cause damage to the product and its components.

- Clean the product and all its components only with a cloth moistened with clear water.

**i Communication disturbances in the local network**

The IP address range 192.168.12.0 to 192.168.12.255 is occupied for communication amongst SMA products and for direct access to SMA products.

Communication problems might occur if this IP address range is used in the local network.

- Do not use the IP address range 192.168.12.0 to 192.168.12.255 in the local network.

**i DHCP Server is recommended.**

The DHCP server automatically assigns the appropriate network settings to your nodes in the local network. A manual network configuration is therefore not necessary. In a local network, the Internet router is usually the DHCP server. If the IP addresses in the local network are to be assigned dynamically, DHCP must be activated in the Internet router (see the Internet router manual). In order to receive the same IP address by the internet router after a restart, set the MAC address binding.

In networks where no DHCP server is active, proper IP addresses must be assigned from the free address pool of the network segment to all network participants to be integrated during commissioning.

**i A country data set must be set for feed-in operation**

A country data set must be set (e.g. via the product commissioning wizard or a System Manager) in order for the inverter to start feed-in operation during commissioning.

If no country data set is set, then feed-in operation will be stopped. This state is signaled by the green and red LEDs flashing simultaneously.

The inverter will automatically start feed-in operation only after the inverter configuration is completed.

**i The country data set must be set correctly.**

If you select a country data set which is not valid for your country and purpose, it can cause a disturbance in the PV system and lead to problems with the grid operator. When selecting the country data set, you must always observe the locally applicable standards and directives as well as the properties of the PV system (e.g. PV system size, grid-connection point).

- If you are not sure which standards and directives are valid for your country or purpose, contact the grid operator.

### 3 Scope of Delivery

Check the scope of delivery for completeness and any externally visible damage. Contact your distributor if the scope of delivery is incomplete or damaged.

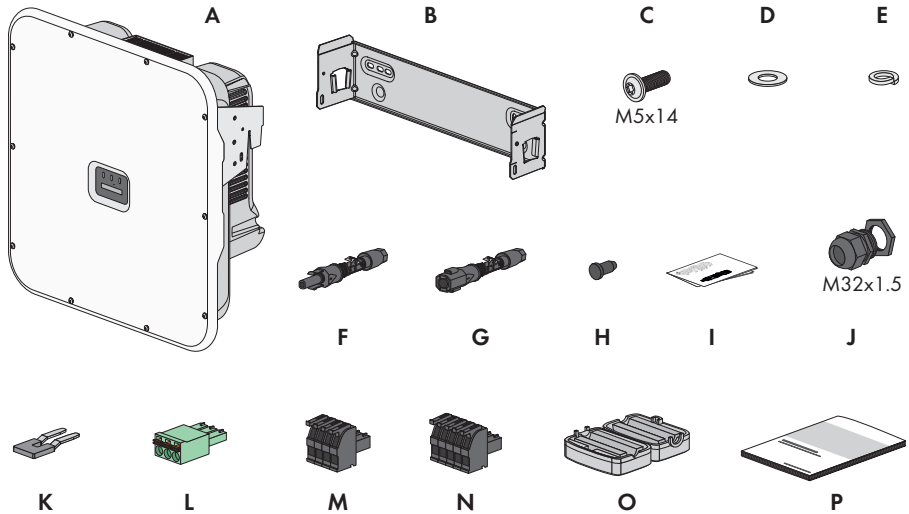

Figure 1: Components included in scope of delivery

Position	Quantity	Designation
A	1	Inverter
B	1	Wall mounting bracket
C	3	Screw M5x14
D	1	Washer
E	1	Conical spring washer
F	6	Positive DC connector
G	6	Negative DC connector
H	12	Sealing plug for DC connectors
I	1	Installation manual for DC connectors
J	1	Cable gland M32x1.5 with counter nut
K	1	Jumper
L	1	3-pole terminal block
M	1	4-pole terminal block
N	1	5-pole terminal block

Position	Quantity	Designation
O	2	Ferrite for network port
P	1	<p>Quick reference guide with password label on the rear side</p> <p>The label contains the following information:</p> <ul style="list-style-type: none"><li>• PIC (Product Identification Code) identification key for registering the system in Sunny Portal</li><li>• RID (Registration Identifier) registration ID for registering the system in Sunny Portal</li><li>• Wi-Fi password WPA2-PSK (WiFi Protected Access 2 - Preshared Key) for direct connection to the product via Wi-Fi</li><li>• Device Key (DEV KEY) for resetting the administrator password</li></ul>

## 4 Product Overview

### 4.1 Device function

In systems with a maximum of 135 kVA, it is possible to use and configure the Sunny Tripower X either as System Manager or as a subordinate inverter.

When using a Sunny Tripower X as System Manager, you can integrate up to 5 additional devices (e.g. 3 inverters, 1 charging station and 1 energy meter) in a system.

You carry out the device function via the commissioning wizard.

#### Inverter as System Manager

If you configure the inverter as System Manager, the inverter as a higher-level device in conjunction with an energy meter takes over the control at the point of interconnection and can receive control signals. The inverter can control other subordinate devices, takes over the monitoring of the system and the communication to the Sunny Portal powered by ennexOS.

#### Lower-level inverter

If you configure the inverter as a subordinate device, it does not take over control. The subordinate inverter receives specifications from the System Manager (e.g. an SMA Data Manager) and implements them. Before a lower-level inverter can be recorded in a System Manager, you must commission all subordinate devices.

### 4.2 System overview

#### 4.2.1 Sunny Tripower X as system manager

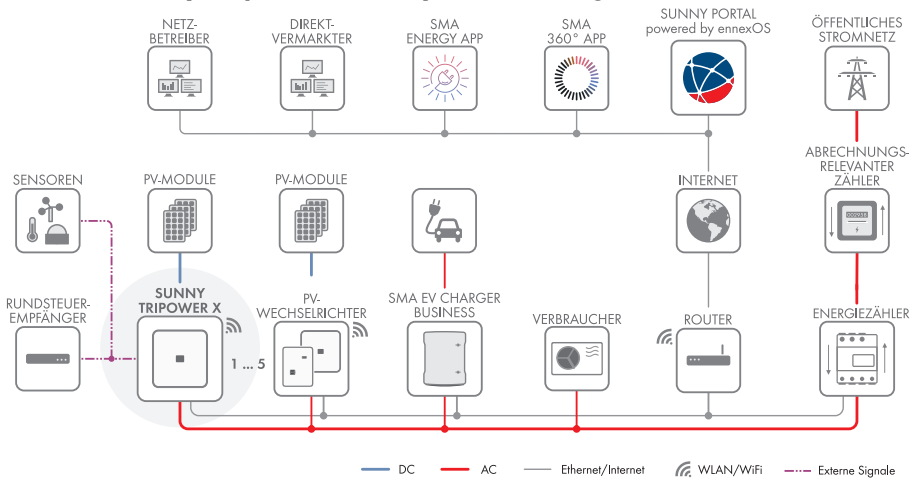

Figure 2: System with Sunny Tripower X as system manager and one energy meter

### 4.2.2 Sunny Tripower X with Sunny Home Manager

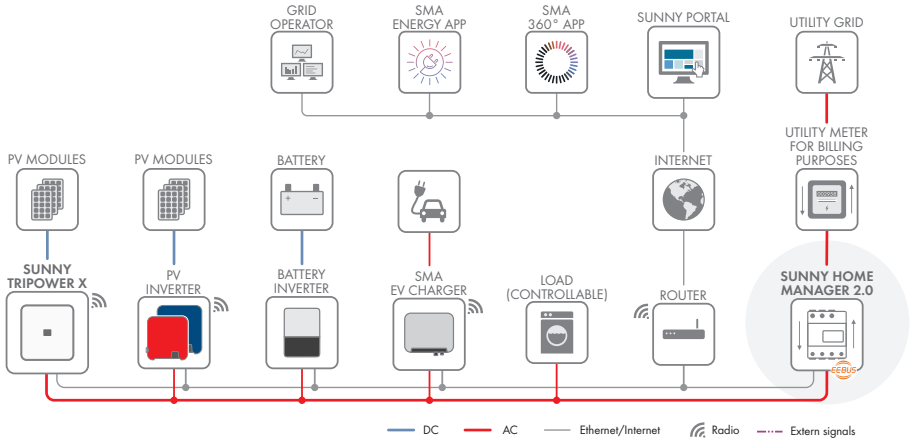

Figure 3: System with Sunny Tripower X and Sunny Home Manager 2.0 as System Manager

### 4.2.3 Sunny Tripower X with SMA Data Manager as System Manager

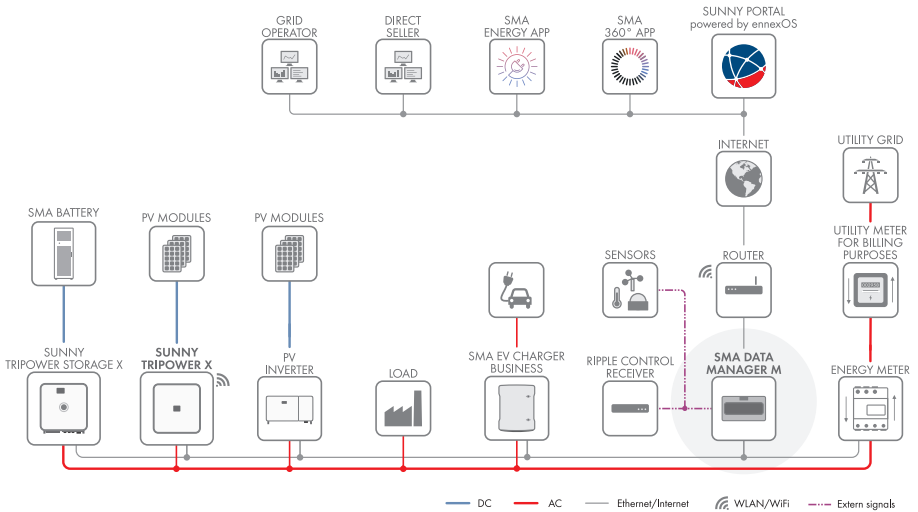

Figure 4: System with Sunny Tripower X and SMA Data Manager as system manager

### 4.3 Product Description

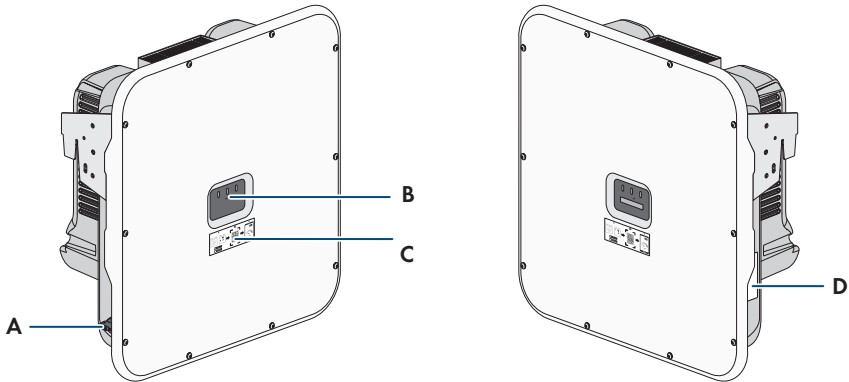



















Figure 5: Design of the product

Position	Designation
A	DC load-break switch
B	LEDs The LEDs indicate the operating state of the product.
C	A label with a QR code to be scanned using the SMA apps
D	Type label The type label clearly identifies the product. The type label must remain permanently attached to the product. You will find the following information on the type label: <ul style="list-style-type: none"> <li>• Device type (Model)</li> <li>• Serial number (Serial No. or S/N)</li> <li>• Date of manufacture</li> <li>• Device-specific characteristics</li> </ul>

### 4.4 Symbols on the Product

Symbol	Explanation
	Beware of a danger zone This symbol indicates that the product must be additionally grounded if additional grounding or equipotential bonding is required at the installation site.
	Beware of electrical voltage The product operates at high voltages.

Symbol	Explanation
	Beware of hot surface The product can get hot during operation.
	Danger to life due to high voltages in the inverter; observe a waiting time of 5 minutes. High voltages that can cause lethal electric shocks are present in the live components of the inverter. Prior to performing any work on the inverter, disconnect it from all voltage sources as described in this document.
	Observe the documentations Observe all documentations supplied with the product.
	Inverter Together with the green LED, this symbol indicates the operating state of the inverter.
	Observe the documentation Together with the red LED, this symbol indicates an error.
	Data transmission Together with the blue LED, this symbol indicates the status of the network connection.
	Grounding This symbol indicates the position for the connection of an additional grounding conductor.
	Three-phase alternating current with neutral conductor
	Direct current
	DC load-break switch
	The product has no galvanic isolation.

Symbol	Explanation
	<p>WEEE designation</p> <p>Do not dispose of the product together with the household waste but in accordance with the disposal regulations for electronic waste applicable at the installation site.</p>
	The product is suitable for outdoor installation.
<b>IP65</b>	<p>Degree of protection IP65</p> <p>The product is protected against the penetration of dust and water that is directed as a jet against the enclosure from all directions.</p>
<b>CE</b>	<p>CE marking</p> <p>The product complies with the requirements of the applicable EU directives.</p>
<b>UK CA</b>	<p>UKCA marking</p> <p>The product complies with the regulations of the applicable laws of England, Wales and Scotland.</p>
	<p>RoHS labeling</p> <p>The product complies with the requirements of the applicable EU directives.</p>
	<p>RCM (Regulatory Compliance Mark)</p> <p>The product complies with the requirements of the applicable Australian standards.</p>

## 4.5 Interfaces and Functions

### 4.5.1 User Interface

The product is equipped as standard with an integrated webserver, which provides a user interface for configuring and monitoring the product.

Once the connection has been established to the smart device, use a device (e.g. smartphone, tablet or laptop) to connect to the product's user interface using a web browser.

**Also see:**

- [Design of the User Interface](#) ⇒ page 66
- [Access rights to the user interface](#) ⇒ page 67

### 4.5.2 Device Key (DEV KEY)

If you have forgotten the administrator password for the product, you can reset the administrator account with the Device Key and assign a new password. The Device Key can be used to prove the identity of the product in digital communication. The Device Key is located on the back of the quick reference guide that comes with the product. Keep the Device Key safe in case you forget the administrator password.



### 4.5.3 Diagnostic function

The inverter has a diagnostic function for measuring the current/voltage characteristic curve (I-V characteristic curve) of the PV modules connected to DC inputs. The characteristic curve shows deviations and changes from the ideal curve. By this, problems in the PV modules can be detected at an early stage.

**Also see:**

- [Generating the I-V Characteristic Curve ⇒ page 71](#)

### 4.5.4 Digital inputs

The product is equipped with digital inputs as standard.

Digital input **DI 1-4** is intended for connection of a ripple control receiver or remote terminal unit for control by the grid operator. Digital input **DI 1-4** can only be used if the inverter is configured as System Manager.

Digital input **DI 5** is intended for connection of a fast-stop switch (break contact or make contact).

Digital input **DI 5** can only be used if the inverter is configured as System Manager.

Digital input **DI 6** is intended for connection of an external grid and PV system protection device (break contact or make contact). Digital input **DI 6** can only be used if the inverter is configured as System Manager or as a subordinate device.

**Also see:**

- [Fast stop function ⇒ page 26](#)

### 4.5.5 Integrated Plant Control

The inverter can display the Q(V) characteristic curve specified by the grid operator by means of Integrated Plant Control without measuring on the grid-connection point. The inverter can automatically compensate equipment installed between the inverter and the point of interconnection after having activated the function (for information on the system configuration refer to the Technical Information "Integrated Plant Control" at [www.SMA-Solar.com](http://www.SMA-Solar.com)).

### 4.5.6 Modbus

The product is equipped with a Modbus interface. The Modbus interface is deactivated by default and must be configured as needed.

The Modbus interface of the supported SMA products is designed for industrial use – via SCADA systems, for example – and has the following tasks:

- Remote query of measured values
- Remote setting of operating parameters
- Setpoint specifications for system control

### 4.5.7 Multifunction relay (MFR)

The inverter is equipped with a multifunction relay as standard. The multifunction relay is an interface that can be configured for the operating mode used by a particular system.

The multifunction relay can only be used if the inverter is configured as System Manager.

### 4.5.8 Grid Management Services

The product is equipped with service functions for grid management.

Depending on the requirements of the grid operator, you can activate and configure the functions (e.g. active power limitation) via operating parameters.

### 4.5.9 Fast stop function

The fast stop function is a digital input on the inverter via which the inverter can be disconnected from the utility grid. It can be triggered by means of an external potential-free contact (break contact or make contact). It can be configured whether the disconnection from the utility grid should take place when the contact is open or closed.

The fast stop function is deactivated by default and must be activated in the inverter.

### 4.5.10 SMA ArcFix

SMA ArcFix is an Arc Fault Circuit Interrupter (AFCI). With this function, the inverter effectively detects arcs on the DC side and interrupts them.

A detected electric arc causes the inverter to interrupt feed-in operation. To restart feed-in operation, the operational disruption which has occurred, must be reset through a manual restart.

Alternatively, the arc-fault circuit interrupter can be activated without inhibiting operation.

Depending on the country data set, arc fault detection is activated or deactivated by default. If the installation conditions permit this, you can change the default setting.

#### **i** Arc-fault circuit interrupter without permanent operation interruption

If the arc-fault circuit interrupter (AFCI) is configured with automatic restart, the system should be monitored closely and recurring faults in the AFCI should be investigated immediately by qualified persons. If it is not possible to identify the cause of the error, the inverter should be taken out of operation until the investigation and corrective action can be completed.

Recurring errors may cause damage to neighboring conductors and system components, which could result in more extensive system failures and damage and even to uncontrolled electric arcs and fires.

SMA ArcFix complies with the requirements of the IEC 63027 and corresponds to the following installation classes:

- F-I-AFPE-1-6-1
- F-I-AFPE-2-3-1

**Also see:**

- [Manual restart after electric arc ⇒ page 98](#)

### 4.5.11 SMA Dynamic Power Control

SMA Dynamic Power Control is a pre-installed software that allows a System Manager to control the active and reactive power of up to 5 inverters.

### 4.5.12 SMA ShadeFix

The inverter is equipped with the shade management system SMA ShadeFix. SMA ShadeFix uses an intelligent MPP tracking system to determine the operating point with the highest output during shading conditions. With SMA ShadeFix, inverters use the best possible energy supply from the PV modules at all times to increase yields in shaded systems.

SMA ShadeFix is enabled by default.

The time interval of SMA ShadeFix is usually 6 minutes. This means that the inverter determines the optimum operating point every 6 minutes. Depending on the PV system or shading situation, it may be useful to adjust the time interval.

### 4.5.13 SMA Smart Connected

SMA Smart Connected is the free monitoring of the product via the SMA Sunny Portal. Thanks to SMA Smart Connected, the operator and qualified person will be informed automatically and proactively about product events that occur.

SMA Smart Connected is activated during registration in Sunny Portal. In order to use SMA Smart Connected, it is necessary that the product is permanently connected to Sunny Portal and the data of the operator and qualified person is stored in Sunny Portal and up-to-date.

### 4.5.14 SMA Speedwire

The product is equipped with SMA Speedwire as standard. SMA Speedwire is a type of communication based on the Ethernet standard. SMA Speedwire is designed for a data transfer rate of 100 Mbps and enables optimum communication between Speedwire devices within systems.

The products supports the encrypted system communication with SMA Speedwire Encrypted Communication. In order to be able to use the Speedwire encryption in the system, all Speedwire devices, except for the energy meter (e.g. SMA Energy Meter) must support the function SMA Speedwire Encrypted Communication.

### 4.5.15 Surge arrester type 1+2 or type 2

The inverter has a DIN rail that serves as a mounting location for the DC overvoltage protection. The DC overvoltage protection with surge protection devices of the type 1+2 or type 2 is available as an accessory. The surge protection devices limit dangerous overvoltages.

### 4.5.16 Wi-Fi

The product is equipped with a Wi-Fi interface as standard. The inverter is delivered with the WLAN interface activated as standard. If you do not want to use WLAN, you can deactivate the WLAN interface.

In addition, the product has a WPS function. The WPS function is for automatically connecting the product to a network (e.g. via router) and establish a direct connection between the product and a smart device.

### 4.5.17 Wi-Fi connection to SMA 360° app and SMA Energy app

There is a QR code on the product by default. By scanning the QR Code attached to the product via the SMA 360° app or SMA Energy app, access to the product is established via Wi-Fi and the connection to the user interface is made automatically.

**Also see:**

- [Direct connection via Wi-Fi ⇒ page 63](#)

## 4.6 LED Signals

The LEDs indicate the operating state of the product.

LED signal	Explanation
Green LED and red LED flash simultaneously (2 s on and 2 s off)	No country data set set Operation of the product is stopped because no country data set is set. The product automatically starts operation as soon as the configuration has been carried out (e.g. using the commissioning wizard or via a System Manager).
The green LED is flashing (2 s on and 2 s off)	Waiting for feed-in conditions The conditions for feed-in operation are not yet met. As soon as the conditions are met, the product will start feed-in operation.
The green LED is glowing	Operation The product is in operation.
The green LED is off	No DC voltage is present.
The red LED is glowing	Error Operation of the product has been stopped. In addition, a specific event message and the associated event number are displayed on the user interface of the product or the System Manager (e.g. SMA Data Manager) (see Section 11.1, page 80).
Red LED is flashing (0.25 s on, 0.25 s off, 0.25 s on, 1.25 s off)	Warning Communication with the System Manager failed. The inverter continues to operate with restricted function (e.g., with set fallback level). In addition, a specific event message and the associated event number are displayed on the user interface of the product or the System Manager (e.g. SMA Data Manager) (see Section 11.1, page 80).

LED signal	Explanation
The blue LED is flashing slowly (2 s on and 2 s off)	Communication connection is being established. The product is establishing a connection with a local network or is establishing a direct connection to a smart device (e.g., smartphone, tablet or laptop).
The blue LED is flashing fast (0.25 s on and 0.25 s off)	A System Manager is requesting identification of the product.
The blue LED is glowing	There is an active connection with a local network or there is a direct connection with a smart device (e.g., smartphone, tablet or laptop).
Blue LED is off	There is no active connection.
All 3 LEDs are on	Product update or booting procedure.

## 5 Mounting

### 5.1 Requirements for Mounting

#### 5.1.1 Requirements for the Mounting Location

#### ⚠ WARNING

##### Danger to life due to fire or explosion

Despite careful construction, electrical devices can cause fires. This can result in death or serious injury.

- Do not mount the product in areas containing highly flammable materials or gases.
  - Do not mount the product in potentially explosive atmospheres.
- A solid support surface must be available. When mounted on drywall or similar materials, the product emits audible vibrations during operation which could be perceived as annoying.
  - The mounting location must be suitable for the weight and dimensions of the product.
  - The installation site can be exposed to direct solar irradiation. There is, however, the possibility that the product reduces its power output to avoid overheating due to high temperatures.
  - The mounting location should be freely and safely accessible at all times without the need for any auxiliary equipment (such as scaffolding or lifting platforms). Non-fulfillment of these criteria may restrict servicing.
  - The DC load-break switch of the product must always be freely accessible.
  - All ambient conditions must be met.
  - The ambient temperature should be 0°C to +45°C to ensure optimal operation.

#### 5.1.2 Permitted and prohibited mounting positions

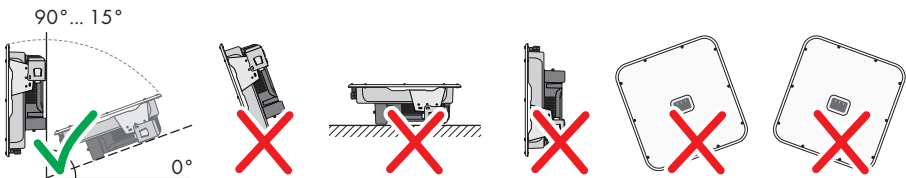

### 5.1.3 Dimensions for mounting

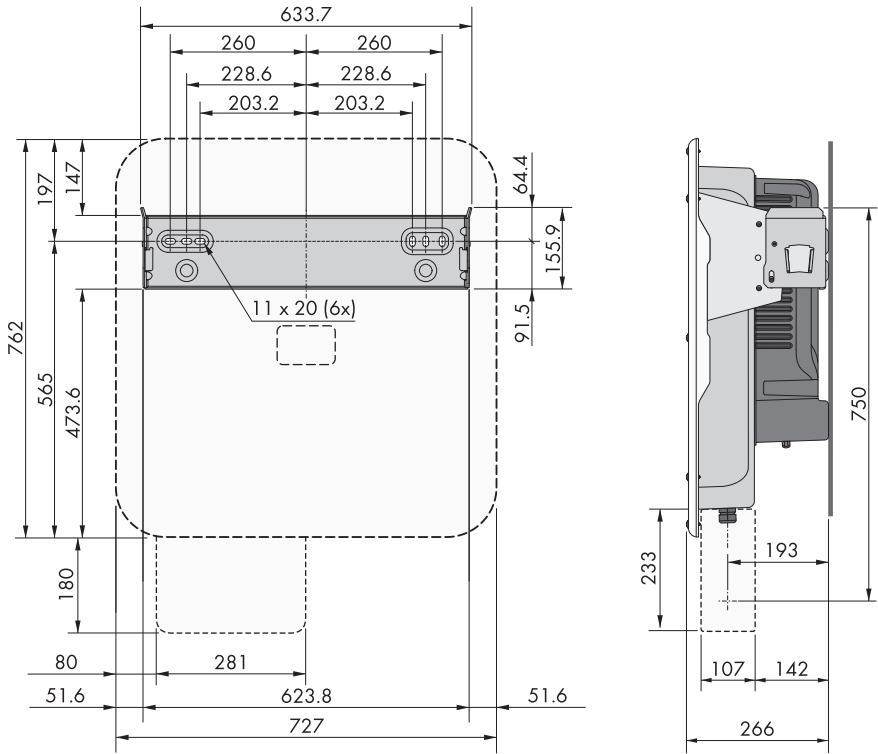

Figure 6: Position of the anchoring points(Dimensions in mm)

### 5.1.4 Recommended clearances for mounting

If you maintain the recommended clearances, adequate heat dissipation will be ensured. Thus, you will prevent power reduction due to excessive temperature.

- Recommended distances to walls, other devices and objects should be maintained.
- If multiple products are mounted in areas with high ambient temperatures, increase the clearances between the products and ensure sufficient fresh-air supply.

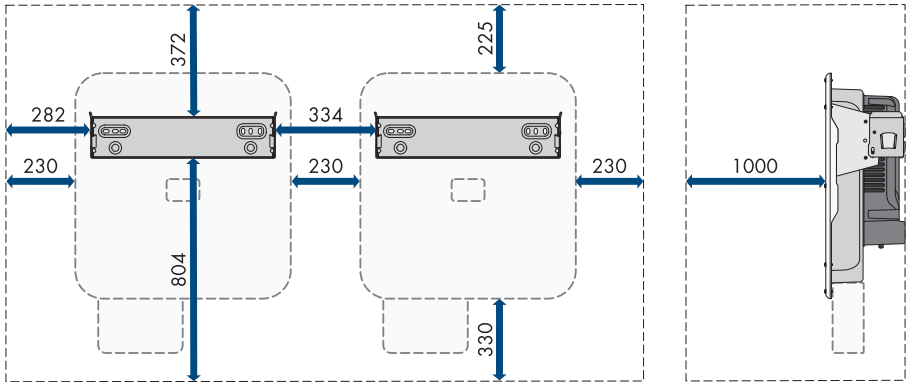

Figure 7: Recommended clearances(Dimensions in mm)

## 5.2 Mount the product.

### ⚠ QUALIFIED PERSON

Additionally required mounting material (not included in the scope of delivery):

- For transport with a hoist: 2 eye bolts (M8)
- For mounting:
  - 2 screws that are suitable for the support surface and the weight of the inverter
  - 2 washers suitable for the screws
  - Where necessary, 2 screw anchors suitable for the support surface and the screws
- To protect the product against theft: 1 padlock suitable for outdoor use. The padlock shackle should have a 7.5 mm diameter.

### ⚠ CAUTION

#### Risk of injury due to weight of product

Injuries may result if the product is lifted incorrectly or dropped while being transported or mounted.

- Transport and lift the product carefully. Take the weight of the product into account.
- Use the carrying handles or hoist when transporting the product. To attach the hoist system, eye bolts must be screwed into the threads provided, which are located on the right and left of the product's mounting lugs.
- Wear suitable personal protective equipment for all work on the product.

#### Procedure:

1. Align the wall mounting bracket horizontally on the wall and mark the position of the drill holes.
2. Set the wall mounting bracket aside and drill the marked holes.
3. Insert screw anchors into the drill holes if the support surface requires them.



- Secure the wall mounting bracket horizontally using screws and washers.

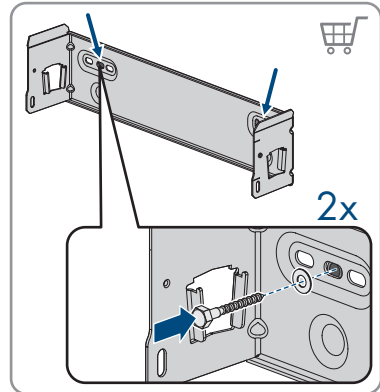

- Hook the inverter into the wall mounting bracket.

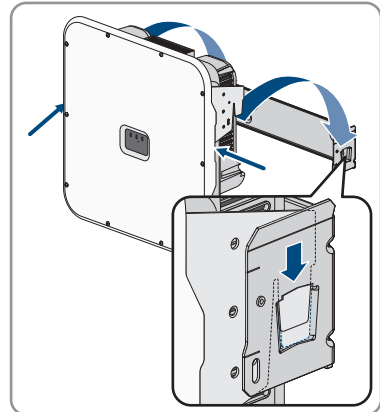

- Ensure that the inverter is securely in place. The inverter is correctly hooked in when the indentations in the wall mounting bracket and the mounting tab line up.

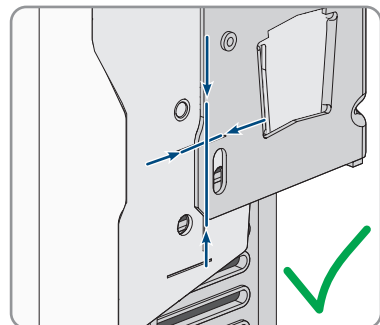

7. Secure the inverter to the wall mounting bracket on both sides with an M5x14 screw each. Insert screws into the screw holes on the left and right tab of the wall mounting bracket and tighten them (TX25, torque: 1.5 Nm).

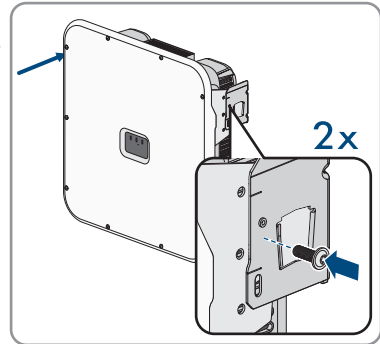

8. To secure the inverter against theft, guide the padlock shackle through the metal tab of the wall mounting bracket and through the mounting tab of the inverter before closing it.

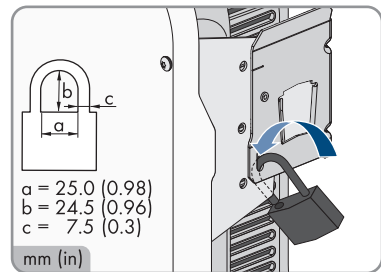

9. Keep the key of the padlock or the number combination for opening it in a safe place.

### 5.3 Mount the DC terminal cover (optional)

#### ⚠ QUALIFIED PERSON

#### Requirements:

- The DC terminal cover must be available as an accessory .

#### Procedure:

1. Drill or punch holes required for connecting the conduits at the pre-notched spots.

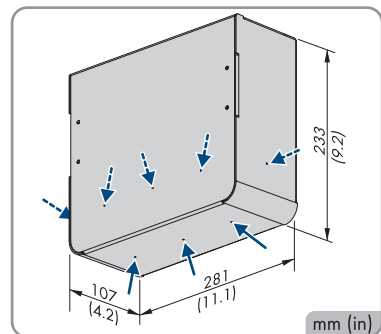

2. Mount the enclosure on the bottom of the inverter using the M5x14 screws from the scope of delivery of the accessory kit (TX25, torque: 4 Nm).

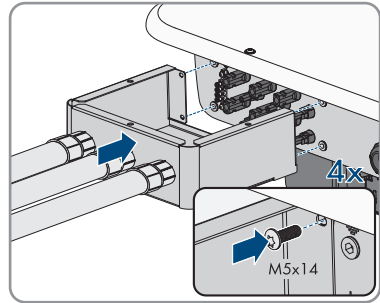

3. Mount the conduits for the DC connection to the DC terminal cover.

## 6 Electrical Connection

### 6.1 Requirements for the electrical connection

#### 6.1.1 Permitted grid configurations

The inverter approved for operation in the following utility grids:

- TN-C
- TN-S
- TN-C-S
- TT<sup>1)</sup>

Operation of the inverter in IT or Delta IT grids is not permitted.

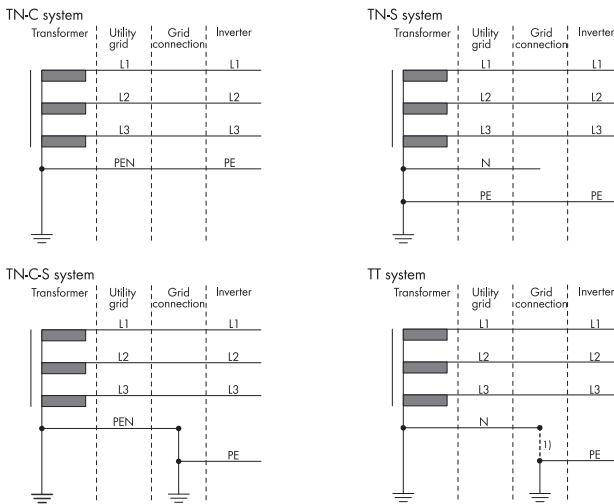

Figure 8: Overview of approved grid configurations

#### 6.1.2 Residual-current monitoring unit

The inverter does not require an external residual-current device when operating. If local regulations require the use of a residual-current device, the following must be observed:

<sup>1)</sup> It must be ensured that the local grounding has a sufficiently low-impedance connection to the grounding of the transformer, otherwise operational leakage currents can lead to potential differences. For error-free operation, the ground potential at the neutral point of the transformer must be the same as that of the grounding conductor connection on the inverter. SMA Solar Technology AG recommends a bridge between N and grounding conductor at the point of interconnection to ensure error-free operation. Improper implementation of the transformer/grid connection with regard to low-impedance grounding/zeroing of the neutral point can lead to a device defect that is not covered by the warranty.

- The inverter is compatible with residual-current devices of type A and B that have a rated residual current of 100 mA or higher. Each inverter in the system must be connected to the utility grid via a separate residual-current device.

### 6.1.3 Load-break switch and cable protection

#### NOTICE

#### Damage to the inverter due to the use of screw-type fuses as load-break switches

Screw-type fuses (e.g. DIAZED fuse or NEOZED fuse) are not load-break switches.

- Do not use screw-type fuses as load-break switches.
- Use a load-break switch or circuit breaker as a load disconnection unit (for information and design examples, see the Technical Information "Miniature circuit breaker" at [www.SMA-Solar.com](http://www.SMA-Solar.com)).

- In PV systems with multiple inverters, protect each inverter with a separate three-phase circuit breaker. Make sure to observe the maximum permissible fuse protection (see Section 14, page 101). This will prevent residual voltage from being present at the corresponding cable after disconnection.
- Loads installed between the inverter and the circuit breaker must be fused separately.

### 6.1.4 Additional grounding

#### **i** Safety in accordance with IEC 62109

The inverter is not equipped with a grounding conductor monitoring device. In order to guarantee safety in accordance with IEC 62109, you must take one of the following measures:

- Connect a grounding conductor made of copper wire with a cross-section of at least 10 mm<sup>2</sup> to the terminal block for the AC cable.
- Connect additional grounding with the same cross-section as the connected grounding conductor to the terminal block for the AC cable (see Section 6.5, page 44). This prevents touch current if the grounding conductor at the terminal block for the AC cable fails.

#### **i** Connection of an additional grounding conductor

In some countries, an additional grounding conductor is generally required. In each case, observe the locally applicable regulations.

- If additional grounding is required, connect an additional grounding that has at least the same cross-section as the connected grounding conductor to the terminal block for the AC cable Connecting Additional Grounding (see Section 6.5, page 44). This prevents touch current if the grounding conductor at the terminal block for the AC cable fails.

### 6.1.5 Equipotential Bonding

If components are used in the PV system that require equipotential bonding (e.g., mounting racks, module frames), these must be connected to a central equipotential panel provided for this purpose.

Observe the installation guidelines and regulations applicable in your country. The enclosure of the inverter is not suitable as equipotential bonding. Incorrect implementation of equipotential bonding can lead to an inverter defect that is not covered under warranty.

### 6.1.6 Overvoltage category

The product can be used in grids of overvoltage category III or lower in accordance with IEC 60664-1. That means that the product can be permanently connected to the grid-connection point of a building. In case of installations with long outdoor cabling routes, additional measures to reduce overvoltage category IV to overvoltage category III are required (see the Technical Information "Overvoltage Protection" at [www.SMA-Solar.com](http://www.SMA-Solar.com)).

### 6.1.7 AC cable requirements

- Conductor type: copper wire
- The conductors must be solid or fine-stranded. When using fine-stranded wire, bootlace ferrules can be used.
- Outer diameter: 14 mm to 25 mm
- Conductor cross-section grounding conductor: 6 mm<sup>2</sup> to 16 mm<sup>2</sup> (The minimum conductor cross-section of 6 mm<sup>2</sup> is only permitted if additional grounding is connected. If no additional grounding is connected, the minimum conductor cross-section is 10 mm<sup>2</sup>.)
- Conductor cross-section of line conductor and neutral conductor: 6 mm<sup>2</sup> to 16 mm<sup>2</sup>
- Insulation stripping length: 18 mm to 20 mm
- Sheath stripping length: 120 mm to 150 mm
- The cable must be dimensioned in accordance with the local and national directives for the dimensioning of cables. The requirements for the minimum wire size derive from these directives. Examples of factors influencing cable dimensioning are: nominal AC current, type of cable, routing method, cable bundling, ambient temperature and maximum desired line losses (for calculation of line losses, see the design software "Sunny Design" from software version 2.0 at [www.SMA-Solar.com](http://www.SMA-Solar.com)).

### 6.1.8 Network cable requirements

The cable length and quality affect the quality of the signal. Observe the following cable requirements:

- Cable type: 100BaseTx
- Cable category: minimum CAT5e
- Plug type: RJ45 of Cat5, Cat5e or higher
- Shielding: SF/UTP, S/UTP, SF/FTP or S/FTP
- Number of insulated conductor pairs and insulated conductor cross-section: at least 2 x 2 x 0.22 mm<sup>2</sup>

- Maximum cable length between 2 nodes when using patch cables: 50 m
- Maximum cable length between 2 nodes when using installation cables: 100 m
- UV-resistant for outdoor use.

## 6.1.9 Requirements for the PV modules per input

### **i** Use of Y adapters for parallel connection of strings

The Y adapters must not be used to interrupt the DC circuit.

- Do not use the Y adapters in the immediate vicinity of the inverter. The adapters must not be visible or freely accessible.
  - In order to interrupt the DC circuit, always disconnect the inverter as described in this document Disconnecting the Inverter from Voltage Sources.
- All PV modules should be of the same type.
  - All PV modules should be aligned and tilted identically.
  - On the coldest day based on statistical records, the open-circuit voltage of the PV array must never exceed the maximum input voltage of the inverter.
  - The same number of series-connected PV modules must be connected to each string.
  - The maximum input current per string must not be exceeded, and must not be greater than the rated through-current of the DC plug connectors.
  - The thresholds for the input voltage and the input current of the inverter must be adhered to.
  - The positive connection cables of the PV modules must be equipped with positive DC connectors.
  - The negative connection cables of the PV modules must be equipped with the negative DC connectors.

### 6.1.10 DC cable requirements

- Outer diameter: 5.5 mm to 8 mm
- Conductor cross-section: 2.5 mm<sup>2</sup> to 6 mm<sup>2</sup>
- Qty single wires: minimum 7
- Nominal voltage: minimum 1000 V
- Using bootlace ferrules is not allowed.

### 6.1.11 Signal cable requirements

The cable length and quality affect the quality of the signal. Observe the following cable requirements:

- Conductor cross-section: 0.5 mm<sup>2</sup> to 0.75 mm<sup>2</sup>
- External diameter: Max. 8 mm
- Maximum cable length: 100 m
- Insulation stripping length: 6 mm
- Sheath stripping length: 150 mm
- UV-resistant for outdoor use

- The cable type and cable-laying method must be appropriate for the application and location.

## 6.2 Overview of the Connection Area

### 6.2.1 View from Below

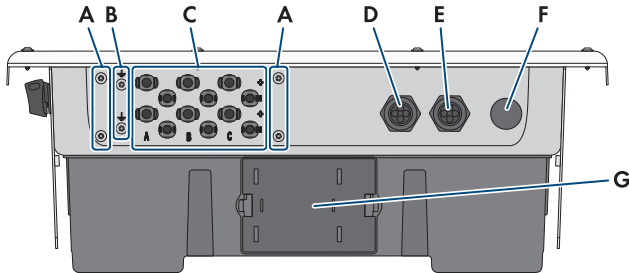

Figure 9: Bottom view of product

Position	Designation
A	Connection point for the DC-TERM-COVER
B	Connection point for an additional grounding
C	Positive and negative connectors for DC connection
D	Enclosure opening for the network cables signal cable
E	Enclosure opening for connecting to the digital inputs and to the multifunction relay
F	Enclosure opening for connecting the utility grid
G	Fan drawer



## 6.2.2 Interior View

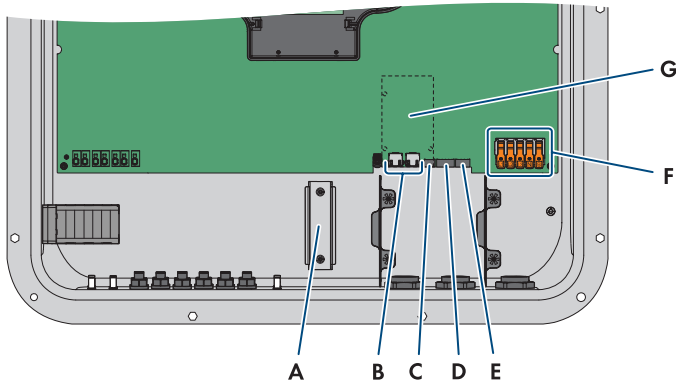

Figure 10: Connection areas in the interior of the product

Position	Designation
A	DIN rail for installing the DC overvoltage protection
B	Network Ports
C	<b>MFR</b> slot for connection to the multifunction relay
D	Slot <b>DI 1-4</b> for connecting a ripple control receiver
E	Slot <b>DI 5-6</b> for connecting digital signal sources (e.g. fast-stop switch or switch for an external grid and PV system protection device) Slot <b>DI 7</b> is not assigned
F	Terminal blocks for AC connection
G	Slot for module (e.g. SMA Sensor Module)

## 6.3 Electrical connection procedure

### ⚠ QUALIFIED PERSON

This section describes the procedure for the electrical connection of the product. It provides an overview of the steps, which must be performed in the prescribed sequence.

Procedure	See
1. Ensure that the requirements for the electrical connection are fulfilled.	Requirements for the electrical connection
2. Connect the AC cables.	
3. Connecting additional grounding (if required)	Section 6.5, page 44
4. Connecting a ripple control receiver (optional)	Section 6.7, page 46
5. Connect the network cables.	

Procedure	See
6. Connect to the multifunction relay (optional).	Connection to the Multifunction Relay
7. Connect to the digital inputs (optional).	Connection to digital input DI 5-6
8. Connect the PV modules.	DC connection

## 6.4 Connecting the AC Cable

### ⚠ QUALIFIED PERSON

#### Requirements:

- The grid voltage must be within the permissible range. The exact operating range of the inverter is specified in the operating parameters .

#### Procedure:

1. Disconnect the miniature circuit breaker from all 3 line conductors and secure against reconnection.
2. Ensure that the DC load-break switch is in the **OFF** position.

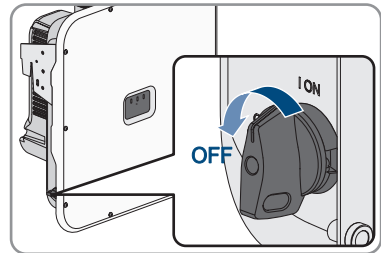

3. If your country requires the DC load-break switch to be protected against reconnection, secure the DC load-break switch against reconnection with a padlock.

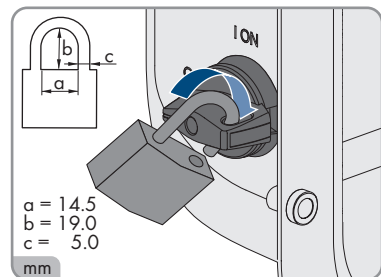

4. Unscrew the screws of the enclosure lid with a Torx screwdriver (TX 25) and remove the enclosure lid carefully forward.

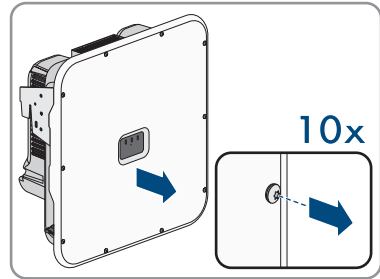

5. Remove the adhesive tape from the enclosure opening for the AC connection.  
6. Insert the cable gland M32x1.5 into the opening and tighten it with the counter nut from the inside.

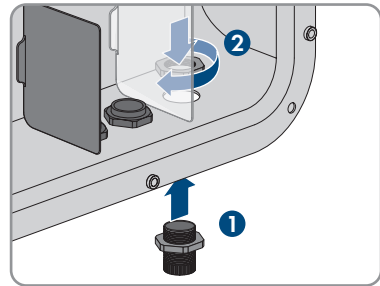

7. Route the AC cable into the inverter through the cable gland. If necessary, slightly loosen the swivel nut of the cable gland.  
8. Dismantle the AC cable.  
9. Strip off the conductor insulation by 18 mm to 20 mm each.  
10. If necessary, provide each conductor with a bootlace ferrule.  
11. Press the locking lever of terminal **PE** upward, guide conductor **PE** into the terminal, and press locking lever downward again.

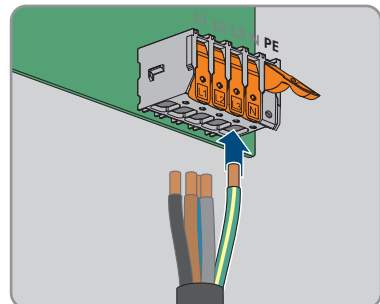

12. For connection without a neutral conductor, use the jumper provided to bridge terminal blocks **PE** and **N**. For this, press the locking levers of terminals **PE** and **N** upward, guide the jumper into the terminals, and press the locking levers downward again.

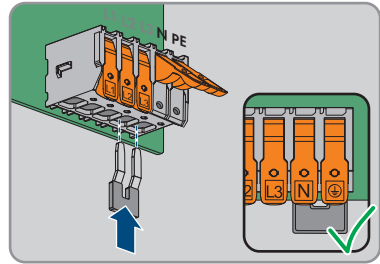

13. Press the locking levers of terminals **L1**, **L2**, **L3**, and if applicable **N** upward, guide conductors **L1**, **L2**, **L3**, and if applicable **N** into the terminals according to the labeling, and press the locking levers downward again.

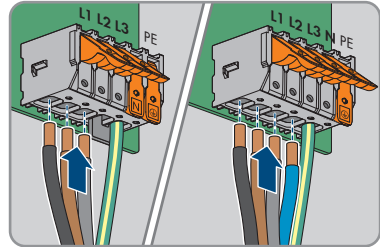

14. Ensure that the correct conductors are assigned to all the terminals.  
15. Ensure that all conductors are securely in place.

**Also see:**

- [AC cable requirements](#) ⇒ page 38

## 6.5 Connecting Additional Grounding

If additional grounding or equipotential bonding is required locally, you can connect additional grounding to the product. This prevents touch current if the grounding conductor at the terminal for the AC cable fails.

**Additionally required material (not included in the scope of delivery):**

- 1 grounding cable
- 1 ring terminal lug M5

**Cable requirements:**

- The cable cross-section must correspond at least to the cross-section of the grounding conductor connected to the terminal block for the AC connection.

**Procedure:**

1. Dismantle the grounding cable.

2. Fit a terminal lug to the grounding cable.

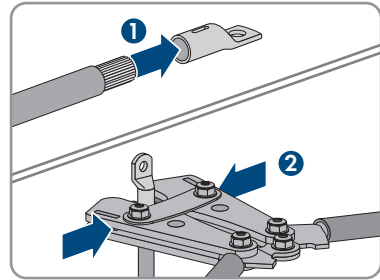

3. Clean the contact surfaces of the terminal lug using a clean cloth and ethanol cleaning agent and do not touch the contact surfaces after cleaning.

4. Connect the grounding cable to a connection point for additional grounding or equipotential bonding using a hexagon socket screw M5x14, a washer, and a serrated conical spring washer (TX25, torque: 4 Nm).

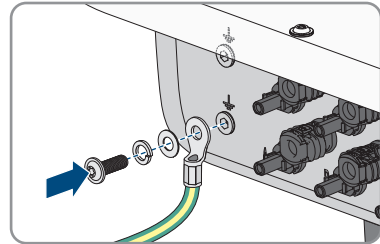

## 6.6 Connecting the Network Cables

### ⚠ QUALIFIED PERSON

### ⚠ DANGER

#### **Danger to life due to electric shock in case of overvoltages and if surge protection is missing**

Overvoltages (e. g. in the event of a flash of lightning) can be further conducted into the building and to other connected devices in the same network via the network cables or other data cables if there is no surge protection. Touching live parts and cables results in death or lethal injuries due to electric shock.

- Ensure that all devices in the same network are integrated in the existing overvoltage protection.
- When laying the network cable outdoors, ensure that there is suitable surge protection at the network cable transition from the product outdoors to the network inside the building.
- The Ethernet interface of the product is classified as "TNV-1" and offers protection against overvoltages of up to 1.5 kV.

#### **Additionally required material (not included in the scope of delivery):**

- Network cables (see Section 6.1.8, page 38)
- Where required: Field-assembly RJ45 connector.

**Procedure:**

1. Disconnect the inverter from all voltage sources (see Section 9, page 75).
2. Unscrew the swivel nut from the cable gland.
3. Thread a swivel nut over each network cable.
4. Remove the four-hole cable support sleeve from the cable gland.
5. For each network cable, remove one of the plugs from the enclosure openings and cut into each enclosure opening with a utility knife.
6. Insert each network cable into one of the enclosure opening.
7. Press the 4-hole cable support sleeve into the cable gland and guide each network cable to the network port.
8. When using a self-assembly network cable, assemble the RJ45 connectors and connect them to each network cable (see connector documentation).
9. Insert each network cable into one of the network ports.

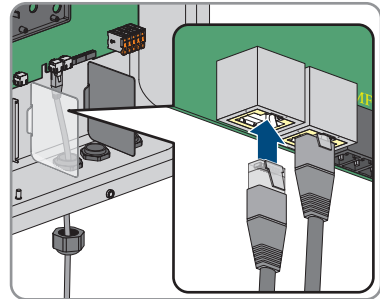

10. Ensure that the network cables are securely in place by pulling slightly on them.
11. Place a ferrite around each network cable.

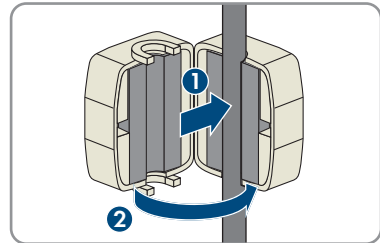

12. Tighten the swivel nut on the cable gland hand-tight. This will secure the network cables in place.
13. If the inverter is installed outdoors, install overvoltage protection for all components in the network.
14. If you would like to integrate the inverter into a local network, connect the other end of a network cable to the local network (e.g., via a router).

## 6.7 Connection of a Ripple Control Receiver

### 6.7.1 Digital input DI 1-4

A ripple control receiver or remote terminal unit can be connected to digital input **DI 1-4**.

In a system with multiple inverters, the ripple control receiver must be connected to digital input **DI 1-4** of the System Manager.

Also see:

- [Configuring the digital input DI 1-4 for the external setpoint](#) ⇒ page 70

## 6.7.2 Pin assignment DI 1-4

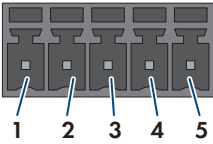
Digital input DI-4	Pin	Assignment
	1	Digital input 1
	2	Digital input 2
	3	Digital input 3
	4	Digital input 4
	5	Voltage supply output

## 6.7.3 Circuitry overview DI 1-4

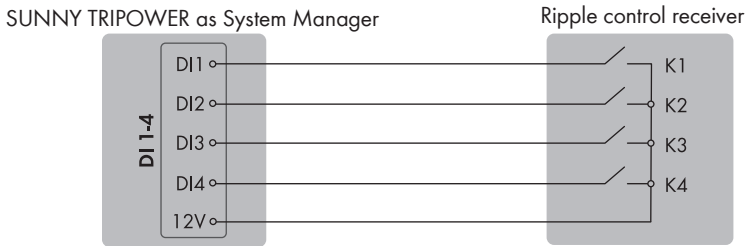

Figure 11: Connection of a ripple control receiver to digital input DI 1-4 of the Sunny Tripower that is to be configured as System Manager

## 6.7.4 Connecting the ripple control receiver to DI 1-4

### ⚠ QUALIFIED PERSON

Connection of the ripple control receiver must be carried out at the inverter that is to be configured as System Manager.

1. Connect the connection cable to the ripple control receiver or the remote terminal unit (see the manual from manufacturer).
2. Disconnect the inverter from all voltage sources (see Section 9, page 75).
3. Unscrew the swivel nut from the cable gland.
4. Remove the four-hole cable support sleeve from the cable gland.
5. Remove the plug from one of the enclosure openings and cut into the enclosure opening with a utility knife.
6. Insert the cable into the enclosure opening.

7. Press the four-hole cable support sleeve with the cable into the cable gland and guide the cable to slot **DI 1-4**. Ensure that the unused enclosure openings of the four-hole cable support sleeve are sealed with sealing plugs.
8. Strip 6 mm of the cable insulation at maximum.
9. Release the conductor entries on the supplied 5-pole plug.

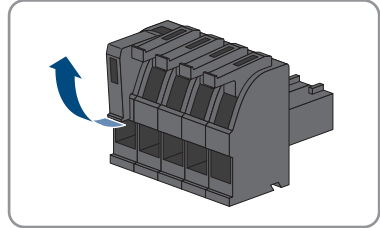

10. Connect the conductors of the connection cable to the supplied 5-pole plug. To do so, plug the conductors into the conductor entries and close the conductor entries. Observe the plug assignment.

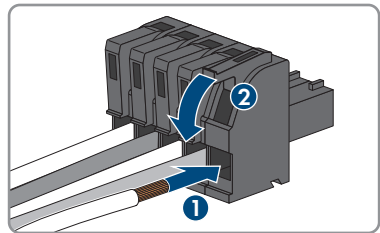

11. Plug the 5-pole plug into the socket **DI 1-4** on the product. Observe the pin assignment.

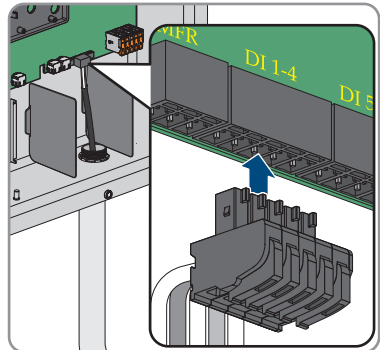

12. Ensure that the plug is securely in place.
13. Ensure that all conductors are correctly connected.
14. Ensure that the conductors sit securely in the terminal points.
15. Tighten the swivel nut on the cable gland hand-tight.

#### Also see:

- [Digital input DI 1-4](#) ⇒ page 46
- [Pin assignment DI 1-4](#) ⇒ page 47
- [Circuitry overview DI 1-4](#) ⇒ page 47



## 6.8 Connection to the Multifunction Relay

### 6.8.1 Digital output (MFR)

The multifunction relay (MFR) is a digital output that can be specifically configured to the system. In a system with multiple inverters, you must carry out the connection to the multifunction relay of the System Manager.

### 6.8.2 Pin assignment MFR

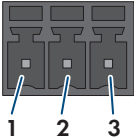
Digital input	Pin	Assignment
	1	NO
	2	CO
	3	NC

### 6.8.3 Connect signal source to MFR

#### ⚠ QUALIFIED PERSON

#### Requirements:

- The technical requirements of the multifunction relay must be met (see Section 14, page 101).

#### Procedure:

1. Disconnect the inverter from all voltage sources (see Section 9, page 75).
2. Unscrew the swivel nut from the cable gland.
3. Remove the four-hole cable support sleeve from the cable gland.
4. Remove the plug from one of the enclosure openings and cut into the enclosure opening with a utility knife.
5. Insert the cable into the enclosure opening.
6. Press the four-hole cable support sleeve with the cable into the cable gland and guide the cable to slot **MFR**. Ensure that the unused enclosure openings of the four-hole cable support sleeve are sealed with sealing plugs.
7. Strip 6 mm of the cable insulation at maximum.
8. Connect the cable to the 3-pole terminal block according to the operating mode. Ensure that the conductors are plugged completely into the terminal points up to their insulation.

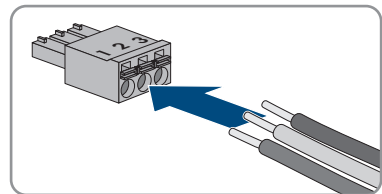

9. Insert the 3-pole terminal block with the connected conductors into slot **MFR**.

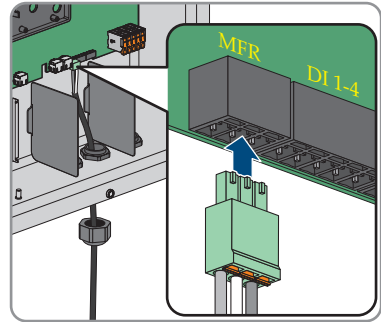

10. Ensure that the terminal block is securely in place.
11. Ensure that all conductors are correctly connected.
12. Ensure that the conductors sit securely in the terminal points. Tip: To release the conductors, open the terminal points using a suitable tool.
13. Tighten the swivel nut on the cable gland hand-tight.

**Also see:**

- [Signal cable requirements](#) ⇒ page 39
- [Digital output \(MFR\)](#) ⇒ page 49
- [Pin assignment MFR](#) ⇒ page 49

## 6.9 Connection to digital input DI 5-6

### 6.9.1 Digital input DI 5-6

You can connect a fast-stop switch at digital input **DI 5**. In a system with multiple inverters, the switch for the fast stop must be connected to digital input **DI 5** of the System Manager.

You can connect a relay for an external grid and PV system protection device at digital input **DI 6**. In a system with multiple inverters, each inverter must be connected with the relay.

**Also see:**

- [Grid and PV system protection](#) ⇒ page 71

### 6.9.2 Pin assignment DI 5-6

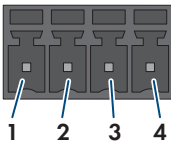
Digital input	Pin	Assignment
	1	Digital input 5
	2	Digital input 6
	3	Not assigned
	4	Voltage supply output

### 6.9.3 Circuitry overview DI 5

SUNNY TRIPOWER as System Manager

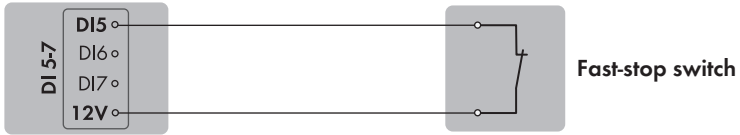

Figure 12: Connection of a switch for the fast stop to digital input DI 5 of the Sunny Tripower that is to be configured as System Manager

### 6.9.4 Circuitry overview DI 6

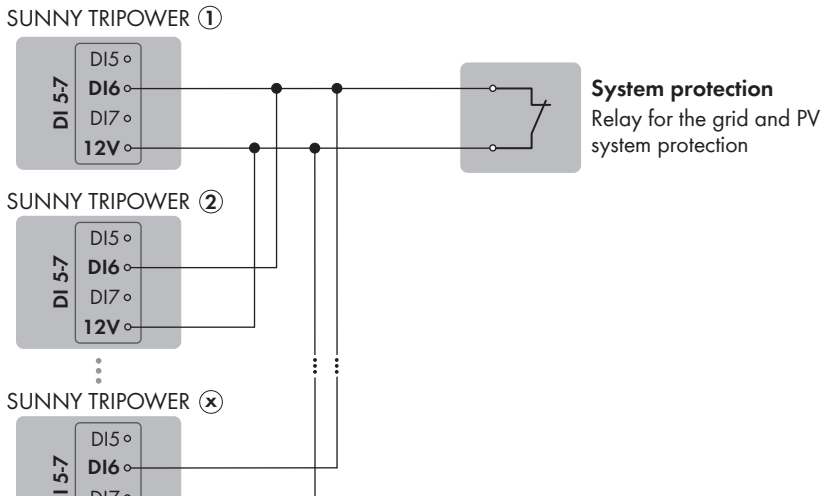

Figure 13: Connection of a relay for the external grid and PV system protection device to digital input DI 6 of one or more Sunny Tripower in the system

### 6.9.5 Connecting Signal Source to Digital Input DI 5-6

**⚠ QUALIFIED PERSON**

**Additionally required material (not included in the scope of delivery):**

- 1 relay for the grid and PV system protection (break contact)
- 1 fast-stop switch (break contact)

**Requirements:**

- The signal source must be technically suitable for connection to the digital inputs (see Section 14, page 101).

**Procedure:**

1. Connect the connection cable to the digital signal source (see the manual from manufacturer).
2. Disconnect the inverter from all voltage sources (see Section 9, page 75).
3. Unscrew the swivel nut from the cable gland.
4. Remove the four-hole cable support sleeve from the cable gland.
5. Remove the plug from one of the enclosure openings and cut into the enclosure opening with a utility knife.
6. Insert the cable into the enclosure opening.
7. Press the four-hole cable support sleeve with the cable into the cable gland and guide the cable to slot **DI 5-7**. Ensure that the unused enclosure openings of the four-hole cable support sleeve are sealed with sealing plugs.
8. Dismantle the cable by 150 mm.
9. Strip off the conductor insulation by 6 mm.
10. Release the conductor entries on the supplied 4-pole plug.

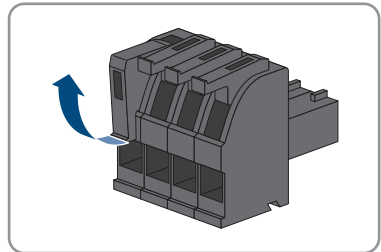

11. Connect the conductors of the connection cable to the supplied 4-pole plug. To do so, plug the conductors into the conductor entries and close the conductor entries. Observe the plug assignment.

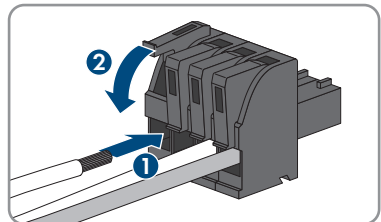

12. Plug the 4-pole plug into the socket **DI 5-7** on the product. Observe the pin assignment.

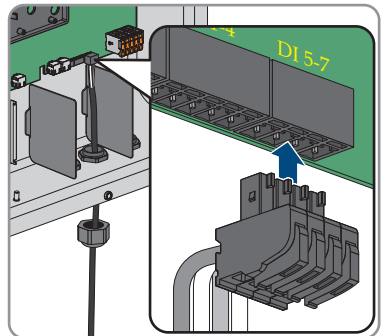

13. Ensure that the plug is securely in place.

14. Ensure that all conductors are correctly connected.
15. Ensure that the conductors sit securely in the terminal points.
16. Tighten the swivel nut on the cable gland hand-tight.

**Also see:**

- Signal cable requirements ⇒ page 39
- Circuitry overview DI 6 ⇒ page 51
- Pin assignment DI 5-6 ⇒ page 50
- Digital input DI 5-6 ⇒ page 50

## 6.10 DC connection

### 6.10.1 Overview of DC connectors

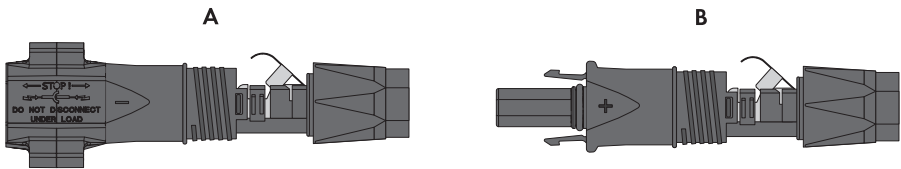

Figure 14: Negative (A) and positive (B) DC connectors

### 6.10.2 Assembling the DC Connectors

#### **⚠ QUALIFIED PERSON**

For connection to the inverter, all PV module connection cables must be fitted with the DC connectors provided. Assemble the DC connectors as described in the following. The procedure is identical for both connectors (+ and -). The graphics for the procedure are shown for only the positive connector as an example. Pay attention to the correct polarity when assembling the DC connectors. The DC connectors are marked with the symbols "+" and "-".

#### **⚠ DANGER**

#### **Danger to life due to electric shock when live components or DC cables are touched**

When exposed to light, the PV modules generate high DC voltage which is present in the DC cables. Touching live DC cables results in death or lethal injuries due to electric shock.

- Do not touch non-insulated parts or cables.
- Disconnect the product from voltage sources and ensure it cannot be reconnected before working on the device.
- Do not disconnect the DC connectors under load.
- Wear suitable personal protective equipment for all work on the product.

## NOTICE

### Destruction of the inverter due to overvoltage

If the open-circuit voltage of the PV modules exceeds the maximum input voltage of the inverter, the inverter can be destroyed due to overvoltage.

- If the open-circuit voltage of the PV modules exceeds the maximum input voltage of the inverter, do not connect any strings to the inverter and check the design of the PV system.

#### Procedure:

1. Strip approx. 15 mm of the cable insulation.
2. Insert the stripped cable into the DC connector up to the stop. When doing so, ensure that the stripped cable and the DC connector are of the same polarity.

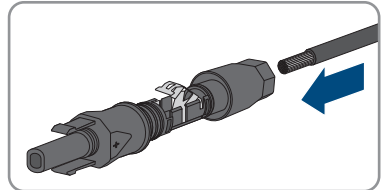

3. Press the clamping bracket down until it audibly snaps into place.

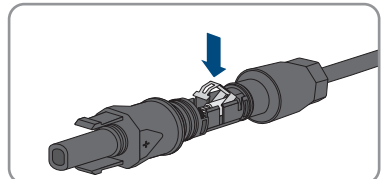

- The stranded wire can be seen inside the clamping bracket chamber.

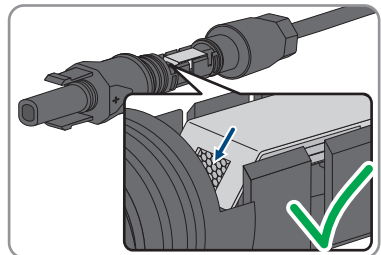

4. If the stranded wire is not visible in the chamber, the cable is not correctly inserted and the connector must be reassembled. To do this, the cable must be removed from the connector.
5. To take out the cable, loosen the clamping bracket. To do so, insert a screwdriver (blade width: 3.5 mm) into the clamping bracket and pry the clamping bracket open.

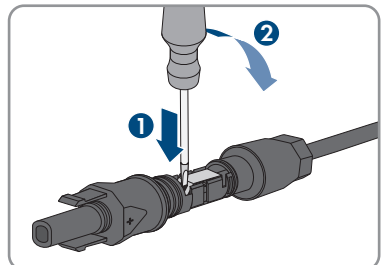

6. Remove the cable and go back to step 2.
7. Push the swivel nut up to the thread and tighten (torque: 2 Nm).

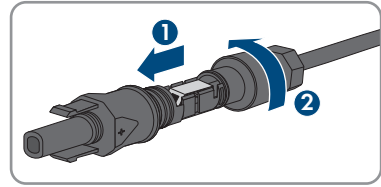

### 6.10.3 Connecting the PV Array

#### **⚠ QUALIFIED PERSON**

#### **⚠ WARNING**

##### **Danger to life due to electric shock from destruction of the measuring device due to overvoltage**

Overvoltage can damage a measuring device and result in voltage being present in the enclosure of the measuring device. Touching the live enclosure of the measuring device results in death or lethal injuries due to electric shock.

- Only use measuring devices with a DC input voltage range of 1000 V or higher.

#### **NOTICE**

##### **Damage to the product due to ground fault on DC side during operation**

Due to the transformerless topology of the product, the occurrence of ground faults on DC side during operation can lead to irreparable damage. Damages to the product due to a faulty or damaged DC installation are not covered by warranty. The product is equipped with a protective device that checks whether a ground fault is present during the starting sequence. The product is not protected during operation.

- Ensure that the DC installation is carried out correctly and no ground fault occurs during operation.

#### **NOTICE**

##### **Damage to the DC connectors due to the use of contact cleaner of other cleaning agents**

Some contact cleaners or other cleaning agents may contain substances that decompose the plastic of the DC connectors.

- Do not use contact cleaners or other cleaning agents for cleaning the DC connectors.

## NOTICE

### Destruction of the inverter due to overvoltage

If the open-circuit voltage of the PV modules exceeds the maximum input voltage of the inverter, the inverter can be destroyed due to overvoltage.

- If the open-circuit voltage of the PV modules exceeds the maximum input voltage of the inverter, do not connect any strings to the inverter and check the design of the PV system.

### Requirements:

- The miniature circuit breaker must be switched off and prevented from being reconnected.
- The DC load-break switch is set to **OFF** and, depending on local regulations, can be secured against restarting using a padlock.
- The cables of the PV modules must be equipped with DC connectors.

### Procedure:

1. Position the enclosure lid and first insert the upper-left (position **1**) and lower-right (position **2**) screws and fasten them hand-tight (TX25).

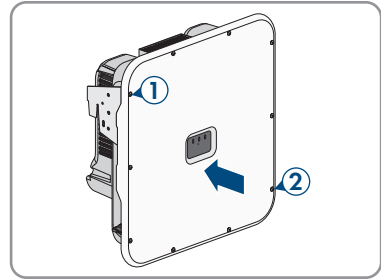

2. Insert and tighten all screws (TX25, torque:  $6 \text{ Nm} \pm 0.3 \text{ Nm}$ ).

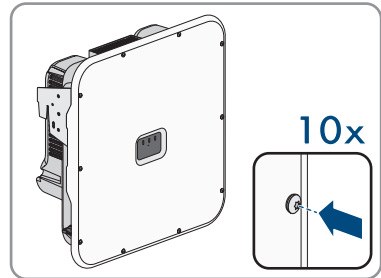

3. Measuring the voltage of the PV array. Ensure that the maximum input voltage of the inverter is adhered to and that there is no ground fault in the PV system.
4. Check whether the DC connectors have the correct polarity.
5. If the DC connector is equipped with a DC cable of the wrong polarity, the DC connector must be reassembled. When this is done, the DC cable must always have the same polarity as the DC connector.
6. Ensure that the open-circuit voltage of the PV array does not exceed the maximum input voltage.



7. Connect the assembled DC connectors to the inverter.

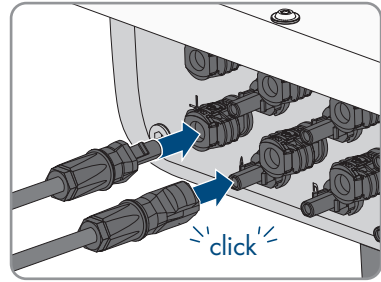

The DC connectors snap into place.

8. Ensure that all DC connectors are securely in place.

9.

**NOTICE**

**Damage to the product due to sand, dust and moisture ingress if the DC inputs are not closed**

The product is only properly sealed when all unused DC inputs are closed with DC connectors and sealing plugs. Sand, dust and moisture penetration can damage the product and impair its functionality.

- Seal all unused DC inputs using the DC connectors and sealing plugs as described in the following. When doing so, do not plug the sealing plugs directly into the DC inputs on the inverter.

10. For unused DC connectors, push down the clamping bracket and push the swivel nut up to the thread.

11. Insert the sealing plug into the DC plug connector and tighten the union nut (tightening torque: 2 Nm).

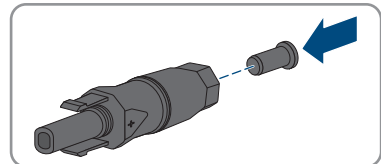

12. Insert the DC connectors with sealing plugs into the corresponding DC inputs on the inverter.

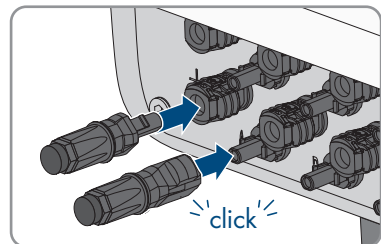

The DC connectors snap into place.

13. Ensure that the DC connectors with sealing plugs are securely in place.

**Also see:**

- Requirements for the PV modules per input ⇒ page 39

## 7 Commissioning

### 7.1 Procedure for commissioning as a subordinate device

#### QUALIFIED PERSON

This section describes the procedure of commissioning an inverter that is used in systems with or without System Manager.

In systems with System Manager, only 1 device can be used as System Manager at a time (e.g. SMA Data Manager or an inverter as System Manager). All other devices must be configured as a subordinate device and recorded in the System Manager.

It provides an overview of the steps, which must be performed in the prescribed sequence.

Procedure	See
1. Commission the inverter.	Section 7.3, page 60
2. Establish a connection to the user interface of the inverter. There are various connection options to choose from for this: <ul style="list-style-type: none"> <li>• Direct connection via Wi-Fi</li> <li>• Connection via WLAN in the local network</li> <li>• Connection via Ethernet in the local network</li> </ul>	Section 8.1.2, page 63 Section 8.1.1, page 61
3. If required, change the network configuration on the welcome page. The automatic network configuration recommended by SMA Solar Technology AG via DHCP server is activated by default. Only change the network configurations if the default configuration is not suitable for your network.	Commissioning Assistant
4. Carry out the configuration using the Commissioning Assistant. When doing so, select <b>Subordinate device</b> in the device function.	Commissioning Assistant
5. Register the inverter as an SMA Speedwire device in the System Manager.	Commissioning Assistant of the System Manager

Also see:

- [Device function](#) ⇒ page 20

### 7.2 Procedure for commissioning as System Manager

#### QUALIFIED PERSON

This section describes the procedure of commissioning an inverter that is used in systems as System Manager.

Only 1 device in the system can be used as System Manager at a time (e.g. SMA Data Manager or an inverter as System Manager). All other devices must be configured as a subordinate device and recorded in the System Manager.

It provides an overview of the steps, which must be performed in the prescribed sequence.

Procedure		See
1.	Commission all SMA Speedwire devices that are to be subordinate to the System Manager (e.g., inverters, energy meters).	Manual of the devices
2.	Commission the inverter that is to be configured as the System Manager.	Section 7.3, page 60
3.	Establish a connection to the user interface of the inverter that is to be configured as System Manager. There are various connection options to choose from for this: <ul style="list-style-type: none"> <li>• Direct connection via Wi-Fi</li> <li>• Connection via WLAN in the local network</li> <li>• Connection via Ethernet in the local network</li> </ul>	Section 8.1.2, page 63 Section 8.1.1, page 61
4.	If required, change the network configuration on the welcome page. The automatic network configuration recommended by SMA Solar Technology AG via DHCP server is activated by default. Only change the network configurations if the default configuration is not suitable for your network.	Commissioning Assistant
5.	Carry out the configuration using the Commissioning Assistant. Select <b>Inverter as System Manager</b> in the device function.	Commissioning Assistant
6.	Make further settings if necessary (e.g., configure multifunction relay, configure arc-fault circuit interrupter).	Section 8, page 61
7.	To monitor the system in the Sunny Portal and view the data visually, create a user account in the Sunny Portal and create a system in the Sunny Portal or add devices to an existing system.	<a href="https://ennexOS.SunnyPortal.com">https://ennexOS.SunnyPortal.com</a>

**Also see:**

- Device function ⇒ page 20

## 7.3 Commissioning the Product

### ⚠ QUALIFIED PERSON

#### Requirements:

- The AC circuit breaker must be correctly rated and mounted.
- The product must be correctly mounted.
- All cables must be correctly connected.
- The enclosure lid must be mounted.

#### Procedure:

1. If necessary, switch on the supply of the connected signal sources.
2. If the DC load-break switch has been secured with a padlock, open and remove the padlock on the DC load-break switch.
3. Switch on the DC load-break switch.

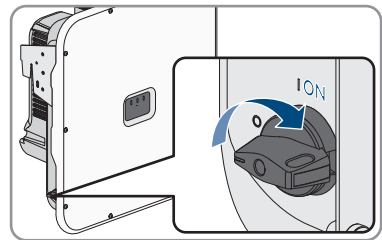

4. Switch on the AC circuit breaker.
5. If the green and red LEDs flash simultaneously during initial commissioning, operation is stopped because no country data set has been set yet. For the inverter to begin operation, the configuration must be completed and a country data set must be set.
6. If the green LED is still flashing, the conditions for activating feed-in operation are not yet met. As soon as the conditions for feed-in operation are met, the inverter starts with feed-in operation and, depending on the available power, the green LED will light up continuously or it will pulse.
7. If the red LED lights up, an event has occurred. Find out which event has occurred and, if necessary, initiate countermeasures.
8. Ensure that the inverter feeds in correctly.

#### Also see:

- Event messages ⇒ page 80

## 8 Operation

### 8.1 Establishing a connection to the user interface

#### 8.1.1 Connection in the local network

##### 8.1.1.1 Access addresses for the product in the local network

###### **i** DHCP Server is recommended.

The DHCP server automatically assigns the appropriate network settings to your nodes in the local network. A manual network configuration is therefore not necessary. In a local network, the Internet router is usually the DHCP server. If the IP addresses in the local network are to be assigned dynamically, DHCP must be activated in the Internet router (see the Internet router manual). In order to receive the same IP address by the internet router after a restart, set the MAC address binding.

In networks where no DHCP server is active, proper IP addresses must be assigned from the free address pool of the network segment to all network participants to be integrated during commissioning.

###### **i** Communication disturbances in the local network

The IP address range 192.168.12.0 to 192.168.12.255 is occupied for communication amongst SMA products and for direct access to SMA products.

Communication problems might occur if this IP address range is used in the local network.

- Do not use the IP address range 192.168.12.0 to 192.168.12.255 in the local network.

If the product is connected to a local network (e.g. via a router or Wi-Fi), the product will receive a new IP address. Depending on the type of configuration, the new IP address will be assigned automatically by the DHCP server (router) or manually by you.

Upon completion of the configuration, the product can only be reached via the listed access addresses:

- Generally applicable access address: IP address manually assigned or assigned by the DHCP server (router) (identification via network scanner software or network configuration of the router).
- Access address: **https://SMA[serial number]** (e.g. **https://SMA0123456789**)

##### 8.1.1.2 Ports for data communication in the local network

In small local networks the use of certain ports is unrestricted. In industrial networks, the use of these ports may require authorization from the system administrator. For proper operation, the outgoing Internet connection must allow the use of the following ports and URLs:

Port and URL	Use
Port 80 and 443 (http/https) update.sunnyportal.de	Updates

Port and URL	Use
Port 123 (NTP) ntp.sunny-portal.com	Time synchronization with Sunny Portal (if not provided by the Internet router)
Port 443 (https/TLS) ldm-devapi.sunnyportal.com	Data transmission
Port 443 (https/TLS) ennexos.sunnyportal.com	User interface
Port 9524 (TCP) wco.sunnyportal.com	SMA Webconnect 1.5 and SMA SPOT

### 8.1.1.3 Establishing a Connection via Ethernet in the local network

#### Requirements:

- The product must be connected to the local network via a network cable (e.g. via a router).
- The product must be integrated into the local network. Tip: You can change the network configuration on the welcome page of the product.
- A smart device (e.g. laptop) must be available.
- The smart device must be in the same local network as the product.
- The respective latest version of one of the following web browsers must be installed on the smart device: Chrome, Edge, Firefox or Safari.

#### Procedure:

1. Open the web browser of your smart device.
2. Enter the access address of the product in the address bar of the web browser.

3. **i Web browser displays warning**

After the access address of the product has been entered, a message might appear indicating that the connection to the user interface of the product is not secure.

- Continue loading the user interface (scroll to bottom and click proceed/advance).
- When you connect to the user interface for the first time, the welcome page opens. The Commissioning Assistant for configuring the product can be started via the welcome page.
- The login page of the user interface opens if the product has already been configured.

#### Also see:

- [SMA Speedwire](#) ⇒ page 27
- [Access addresses for the product in the local network](#) ⇒ page 61
- [Ports for data communication in the local network](#) ⇒ page 61

## 8.1.1.4 Establishing a Connection via WLAN in the Local Network

### Requirements:

- The product must be commissioned.
- The product must be integrated into the local network. Tip: You can change the network configuration on the welcome page of the product.
- A smart device (e.g. laptop) must be available.
- The smart device must be in the same local network as the product.
- The respective latest version of one of the following web browsers must be installed on the smart device: Chrome, Edge, Firefox or Safari.

### Procedure:

1. Open the web browser of your smart device.
2. Enter the access address of the product in the address bar of the web browser.

3.  **Web browser displays warning**

After the access address of the product has been entered, a message might appear indicating that the connection to the user interface of the product is not secure.

- Continue loading the user interface (scroll to bottom and click proceed/advance).
- When you connect to the user interface for the first time, the welcome page opens. The Commissioning Assistant for configuring the product can be started via the welcome page.
  - The login page of the user interface opens if the product has already been configured.

### Also see:

- [Access addresses for the product in the local network ⇒ page 61](#)
- [Ports for data communication in the local network ⇒ page 61](#)

## 8.1.2 Direct connection via Wi-Fi

### 8.1.2.1 Connection options for Wi-Fi direct connection

You have several options to connect the product to a smart device. The procedure can be different depending on the devices. If the procedures described do not apply to your end device, establish the direct connection via Wi-Fi as described in the manual of your end device.

The following connection options are available:

- Direct Wi-Fi connection with WPS (see Section 8.1.2.3, page 64)
- Direct Wi-Fi connection with Wi-Fi network search (see Section 8.1.2.4, page 64)

### 8.1.2.2 Access information for direct Wi-Fi connection

#### Communication disturbances in the local network

The IP address range 192.168.12.0 to 192.168.12.255 is occupied for communication amongst SMA products and for direct access to SMA products.

Communication problems might occur if this IP address range is used in the local network.

- Do not use the IP address range 192.168.12.0 to 192.168.12.255 in the local network.

Access information for the direct WiFi connection can be found below:

- SSID: **SMA[serial number]** (e.g. SMA0123456789)
- Device-specific Wi-Fi password: WPA2-PSK (see type label of the product)
- Default access address: <https://smalogin.net> or <https://192.168.12.3>

### 8.1.2.3 Establishing a direct Wi-Fi connection with WPS

#### Requirements:

- A smart device with WPS function must be available.

#### Procedure:

1. Enable the WPS function on the inverter. To do this, tap on the enclosure lid of the inverter twice.
  - The blue LED flashes quickly for approx. two minutes. The WPS function is active during this time.
2. Enable the WPS function on your smart device.
3. Open the web browser of your smart device and enter <http://smalogin.net> in the address bar.
  - When you connect to the user interface for the first time, the welcome page opens. The Commissioning Assistant for configuring the product can be started via the welcome page.
  - The login page of the user interface opens if the product has already been configured.

#### Also see:

- [Access information for direct Wi-Fi connection](#) ⇒ page 64

### 8.1.2.4 Establishing direct Wi-Fi connection with Wi-Fi network search

1. Search for Wi-Fi networks with your smart device.
2. Select the SSID of the product **SMA[serial number]** in the list with the detected Wi-Fi networks.
3. Enter the device-specific Wi-Fi password (see WPA2-PSK on the type label).



4. Open the web browser of your smart end device and enter **https://smalogin.net** in the address bar.
  - When you connect to the user interface for the first time, the welcome page opens. The Commissioning Assistant for configuring the product can be started via the welcome page.
  - The login page of the user interface opens if the product has already been configured.
5. If the login page of the user interface does not open, enter the IP address **192.168.12.3** or, if your smart device supports mDNS services, **SMA[serial number].local** or **http://SMA[serial number]** in the address bar of the web browser.

**Also see:**

- [Access information for direct Wi-Fi connection](#) ⇒ page 64

## 8.2 WPS function

### 8.2.1 Connection options with WPS

You have several options to use the WPS function. Depending on the possible application of the WPS function, the procedure for activation will vary.

The following options are available:

- WPS for automatic connection to a network (e.g. via a router)
- WPS for direct connection between the product and a smart device

### 8.2.2 Activating WPS for automatic connection

**Requirements:**

- WLAN must be activated in the product.
- WPS must be activated on the router.
- The user interface is open and you are logged in.

**Procedure:**

1. Select the menu **Configuration**.
  2. Select **Network configuration** menu item.
  3. Click on the button **Use WPS** in the **Wi-Fi** section.
  4. Click on [**Save**].
- The WPS function is activated and the automatic connection to the network can be established.

### 8.2.3 Activating WPS for direct connection to a smart device

- Tap on the enclosure lid of the product twice in direct succession.
- The WPS function is activated for about 2 minutes. Activation is signaled by rapid flashing of the blue LED.

### 8.3 Design of the User Interface

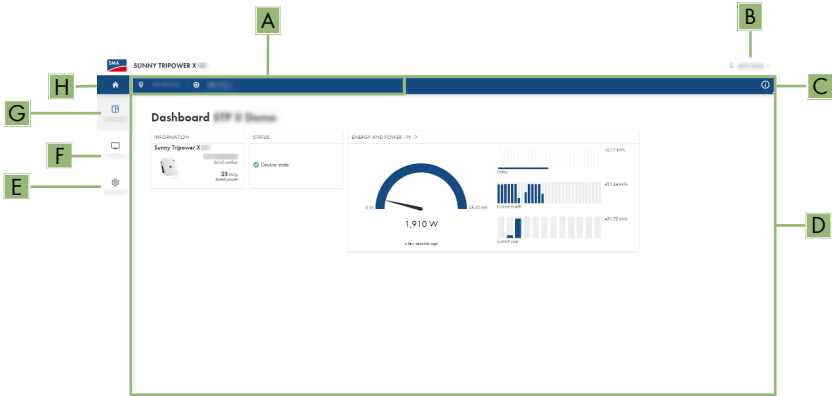

Figure 15: Design of the User Interface

Position	Designation	Description
A	Focus navigation	Enables the navigation between the following levels: <ul style="list-style-type: none"> <li>• System</li> <li>• Device</li> </ul>
B	User settings	Provides the following functions: <ul style="list-style-type: none"> <li>• Configuring personal data</li> <li>• Logout</li> </ul>
C	System information	Displays the following information: <ul style="list-style-type: none"> <li>• System</li> <li>• Device information</li> <li>• Licenses</li> <li>• eManual</li> </ul>
D	Content Area	Displays the dashboard or content of the selected menu.
E	Configuration	Offers different views for configuration, depending on the selected level and user role.
F	Monitoring	Offers different views for monitoring, depending on the scope of the connected devices.
G	Dashboard	Displays information and instantaneous values of the device or system currently selected.
H	Home	Opens the user interface home page

## 8.4 Access rights to the user interface

1 administrator is created during registration. As administrator, you can add further system users who can configure user rights or delete users.

This gives users access to the system and to the devices recorded in the system.

You can assign the following rights for users:

- Administrator
- User
- Installer

## 8.5 Changing parameters

The parameters of the product are set to certain values by default. You can change the parameters to optimize the performance of the product.

This section describes the basic procedure for changing parameters. Always change parameters as described in this section.

### Requirements:

- The user interface must be open and you must be logged in.
- Changes to grid-relevant parameters must be approved by the responsible grid operator, and can only be made as **Administrator** or **Installer**.

### Procedure:

1. Choose the product in the focus navigation.
2. Select the menu **Configuration**.
3. Select the **Parameters** menu item.
4. Call up the parameter via the search function or navigate to the parameter.
5. Change the parameter value.
6. Click on [**Save**].

## 8.6 SMA ArcFix

### QUALIFIED PERSON

You can set the arc-fault circuit interrupter using the following parameters.

Channel	Name	Settings
AfcilsOn	AFCI switched on	Yes No

You can use the following parameters to set the manual restart after an arc fault detection.

Channel	Name	Settings
Operation.ManRstr.IsOn	Manual restart activated	Yes
		No
Operation.ManRstr.ManRstrAFCI	Manual restart after arc detection	On
		Off
		Yes, after 5 electric arc detections within 24 hrs

Also see:

- [Changing parameters](#) ⇒ page 67
- [Manual restart after electric arc](#) ⇒ page 98

## 8.7 Digital output (MFR)

### 8.7.1 Use of the digital output (MFR)

The digital output (MFR) can be switched depending on measured values or states.

You have several options to use the digital output.

Possible use	Category	Explanation
Notification in the event of an error	System state	System is in warning or error state.
Alarm in case of warning or error	System state	System is in error state.
Direct selling enabled	System state	The active power limitation of the direct seller is currently used for the point of interconnection.
Battery state of charge <sup>2)</sup>	Monitoring	Balanced state of charge of all batteries in the system
System active power <sup>2)</sup>	Monitoring	Sum of the active power of all PV inverters in the system.
System reactive power <sup>2)</sup>	Monitoring	Balance of the reactive power of all selected PV inverters in the system.
Reactive power setpoint <sup>2)</sup>	Setpoints	Reactive power value to be set.
Setpoint of active power limitation <sup>2)</sup>	Setpoints	The active power value currently to be set.

<sup>2)</sup> Conditions for activating the outlet signal must be specified

Possible use	Category	Explanation
Standardized measured voltage value for Q(V) <sup>2)</sup>	Grid connection point	Standardized measured voltage value from the point of interconnection. For this, you require a valid Q(V) configuration in the grid management services.
System active power (grid-supplied power) <sup>2)</sup>	Grid connection point	Currently drawn active power.
System active power (grid feed-in) <sup>2)</sup>	Grid connection point	Currently fed-in active power.
System reactive power at the grid connection point <sup>2)</sup>	Grid connection point	Current reactive power.

## 8.7.2 Configure the digital output (MFR)

### QUALIFIED PERSON

#### Requirements:

- A signal source must be connected to the digital output (**MFR**).
- The inverter to which the signal source is connected, must be configured as System Manager.
- The user interface must be open and you must be logged in as **Installer** or **Administrator**.

#### Procedure:

1. Select the product in the focus navigation.
2. Select the menu **Configuration**.
3. Select the menu item **I/O configurations**.
4. Select the type of the I/O channel **Digital output**.
5. Select the use for the digital output.
6. If necessary, activate inversion of the signal. Observe the pin assignment of the terminal block.
7. Click on [**Save**].

## 8.8 Configure the digital input DI 5 for the fast stop

### QUALIFIED PERSON

#### Requirements:

- A switch for a fast stop must be connected to the digital input **DI 5**.
- The inverter to which the switch is connected, must be configured as System Manager.
- The user interface must be open and you must be logged in as **Installer** or **Administrator**.

#### Procedure:

1. Select the product in the focus navigation.
2. Select the menu **Configuration**.

3. Select the menu item **I/O configurations**.
4. Select the type of the I/O channel **Digital input**.
5. Select the use for the digital input **Signal fast stop**.
6. Select the System Manager to which the switch for the fast stop is connected.
7. Select the digital input 5.
8. If necessary, activate inversion of the signal. To decide whether an inversion is necessary, you can see in the live transmission if a signal is applied to the digital input (active) or not (inactive).
9. Assign the name of the I/O channel (e.g. fast stop).
10. Click on **[Save]**.

## 8.9 Configuring the digital input DI 1-4 for the external setpoint

### QUALIFIED PERSON

If the grid operator specifications were not configured via the commissioning wizard, you can carry out the configuration as described below.

#### Requirements:

- A ripple control receiver or remote terminal unit for active power setpoints must be connected to digital input **DI 1-4**.
- The inverter that is connected to the ripple control receiver or the remote terminal unit must be configured as System Manager.
- The user interface must be open and you must be logged in as **Installer** or **Administrator**.

#### Procedure:

1. Select the product in the focus navigation.
2. Select the menu **Configuration**.
3. Select the menu item **Grid management service**.
4. For the active and reactive power select **Configuration & activation**.
5. Open the configuration wizard for **Grid operator specifications** under Active power.
6. Activate **Source for external setpoint**.
7. Select **Digital inputs**.
8. Select **Add digital I/O channel**.
9. Select the System Manager as the source for the digital signal.
10. Select the digital inputs 1-4.
11. Configure the grid operator specifications. You can add a new line for each default value and specify the combination of signals (bits).
12. Click on **[Accept]**.
13. Configure the fallback behavior for missing setpoints.
14. If necessary, configure the behavior in case of setpoint change.

**Also see:**

- Digital input DI 1-4 ⇒ page 46

## 8.10 Grid and PV system protection

### QUALIFIED PERSON

If a relay for a grid and PV system protection is connected to digital input **DI 6**, you must activate the grid and PV system protection.

The grid and PV system protection can be configured via the following parameters:

Channel	Name	Settings
PwrCtlM-dul.GriSysPro	Grid and system protection	On Off

## 8.11 Generating the I-V Characteristic Curve

### QUALIFIED PERSON

**Requirements:**

- The user interface must be open and you must be logged in as **Installer** or **Administrator**.

**Procedure:**

1. Select the product in the focus navigation.
2. Select the **Monitoring** menu.
3. Select the menu item **Diagnosis**.
4. Select the **I-V characteristic curve**.
5. Select [**New measurement**].
6. Use the measurement results to check whether there are any deviations or changes.
7. If necessary, carry out measures to correct the problems on the PV modules.
8. Export the results if necessary.

## 8.12 Activating a Digital Product

If you purchased a digital product via the SMA Online Shop at [www.SMA-Onlineshop.com](http://www.SMA-Onlineshop.com), you can activate this digital product as described below.

Each digital product can only be activated once and has no run-time restriction unless otherwise stated.

**Requirements:**

- An active Internet connection is required at the time of activation.
- The activation key must be present. You can find the activation key on the invoice that was sent to the e-mail address, which has been stored in the customer profile of the SMA Online Shop.
- The user interface must be open and you must be logged in as **Installer** or **Administrator**.

**Procedure:**

1. Select the product in the focus navigation.
2. Select the menu **Configuration**.
3. Select the **Digital products** menu item.
4. In the row of the product to be activated, click the [**Activate**] button.
  - The activation window opens.
5. Enter the activation key and click the [**Activate**] button. Please note: All letters are capital letters. All hyphens are mandatory fields.

## 8.13 Backup file

### 8.13.1 Function and content of the backup file

The backup file is used to transfer configuration information, e.g. when commissioning a replacement device or when restoring previously saved parameter settings.

The backup file includes the following system and device configuration data for your product:

- Grid management services
- Network
- Energy meter
- Sunny Portal setting
- Self-defined Modbus profiles
- System password
- User interface login data
- List of connected devices

The following information is not included in the backup file:

- Notifications
- Historic energy and performance values

### 8.13.2 Creating a Backup File

**Requirements:**

- The user interface must be open and you must be logged in.

**Procedure:**

1. Select the product in the focus navigation.
2. Select the menu **Configuration**.
3. Select the **Update and backup** menu item.
4. Select the [**Create backup file**] button.
5. Enter a password to encrypt the backup file and confirm with [**Create and download backup file**]. Please note that the password will be needed later for importing the backup file.
  - An lbd file with all parameter settings is downloaded.



**Also see:**

- [Function and content of the backup file](#) ⇒ page 72

## 8.14 Carry out a manual firmware update

**Requirements:**

- An update file with the desired inverter firmware must be available. You can download the update file, for example, from the product page under [www.SMA-Solar.com](http://www.SMA-Solar.com).
- The user interface must be open and you must be logged in as **Installer** or **Administrator**.

**Procedure:**

1. Select the product in the focus navigation.
2. Select the menu **Configuration**.
3. Select the **Update and backup** menu item.
4. In the **Manual update** area, click [**Select file**] and select the update file for the product.
  - The user interface confirms that the update file is compatible.
5. If the user interface does not confirm the compatibility of the update file, replace the update file.
6. Select [**Start update**].
7. Follow the instructions in the dialog.
8. Select the **Monitoring** menu.
9. Select the menu item **Event monitor**.
10. Check the events to see whether the firmware update has been completed successfully.

## 8.15 Device Administration

### 8.15.1 Register Devices

You can register new devices and add them to the system on system level. This is required, for example, if your system has been expanded.

**Procedure:**

1. Select the system in the focus navigation.
2. Select the menu **Configuration**.
3. Select the **Device management** menu item.
4. Select the  button.
5. Follow the steps of the device registration wizard.

### 8.15.2 Delete devices

You can delete registered devices on system level.

**Requirements:**

- The login page of the user interface must be open.

**Procedure:**

1. Select the system in the focus navigation.
2. Select the menu **Configuration**.
3. Select the **Device management** menu item.
4. In the row of the device to be deleted, click the ... button.
5. Select **Delete device**.
6. Select [**Delete**] in the displayed message.

## 8.16 Resetting the product to default setting

### **Loss of data due to replacement or due to resetting to default settings**

If the product is reset to the default settings or replaced, all data saved in the product and the admin account will be deleted. The data saved in Sunny Portal can be transmitted to the product after calling up the Sunny Portal system again.

**Requirements:**

- The user interface must be open and you must be logged in.

**Procedure:**

1. Select the product in the focus navigation.
2. Select the menu **Configuration**.
3. Select the menu item **Device properties**.
4. Select the button [**If you want to reset the device to the default settings, click here**].
5. Select [**Reset**].

## 8.17 Deleting the Admin Account

### **QUALIFIED PERSON**

In case the password gets lost, the admin account can be reset and newly created. All system data will be retained.

**Requirements:**

- The Device Key from the label on the back of the supplied manual must be present.
- The login page of the user interface must be open.

**Procedure:**

1. Select the [**Delete admin account?**] button.
2. Enter the Device Key from the label on the back of the supplied manual.
3. Select [**Delete**].
- The product is performing a restart. Then a new admin account can be created.

**Also see:**

- [Device Key \(DEV KEY\) ⇒ page 24](#)

## 9 Disconnecting the Inverter from Voltage Sources

### ⚠ QUALIFIED PERSON

Prior to performing any work on the product, always disconnect it from all voltage sources as described in this section. Always adhere to the prescribed sequence.

### ⚠ WARNING

#### Danger to life due to electric shock from destruction of the measuring device due to overvoltage

Overvoltage can damage a measuring device and result in voltage being present in the enclosure of the measuring device. Touching the live enclosure of the measuring device results in death or lethal injuries due to electric shock.

- Only use measuring devices with a DC input voltage range of 1000 V or higher.

#### Procedure:

1. Disconnect the AC miniature circuit breaker and secure against reconnection.
2. Turn the DC load-break switch of the inverter to position **O**.

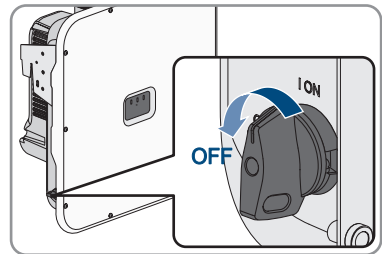

3. If your country requires the DC load-break switch to be protected against reconnection, secure the DC load-break switch against reconnection with a suitable padlock.

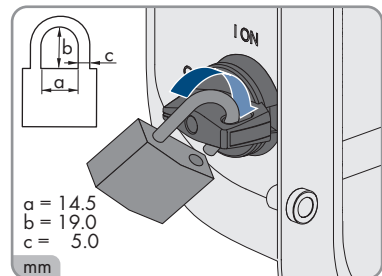

4. If the multifunction relay is used, switch off any supply voltage to the load.
5. Switch off the supply voltage of the digital signal sources if necessary.
6. Wait until the LEDs have gone out.

7. Unscrew the screws (TX25) of the lid if the DC terminal cover is present.

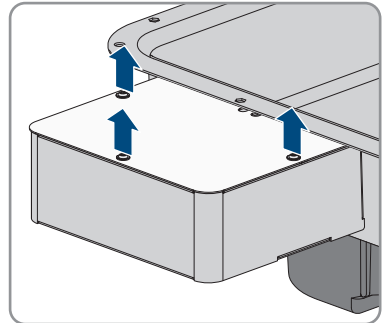

8. Remove the lid downwards if the DC terminal cover is present.

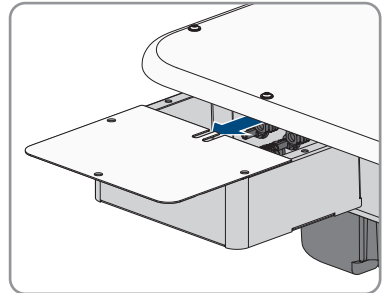

9. Use a current clamp to ensure that no current is present in the DC cables.

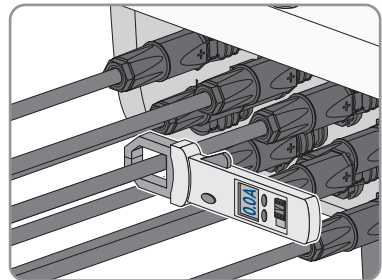

10. Note the position of the DC connectors.

11.

**⚠ DANGER****Danger to life due to electric shock when touching exposed DC conductors or DC plug contacts if the DC connectors are damaged or loose**

The DC connectors can break or become damaged, become free of the DC cables, or no longer be connected correctly if the DC connectors are released and disconnected incorrectly. This can result in the DC conductors or DC plug contacts being exposed. Touching live DC conductors or DC plug connectors will result in death or serious injury due to electric shock.

- Wear insulated gloves and use insulated tools when working on the DC connectors.
- Ensure that the DC connectors are in perfect condition and that none of the DC conductors or DC plug contacts are exposed.
- Carefully release and remove the DC connectors as described in the following.

12. Release and remove the DC connectors. To do so, insert a flat-blade screwdriver or an angled screwdriver (blade width: 3.5 mm) into one of the side slots and pull the DC connectors out. When doing so, do not lever the DC connectors out, but insert the tool into one of the side slots only to release the locking mechanism, and do not pull on the cable.

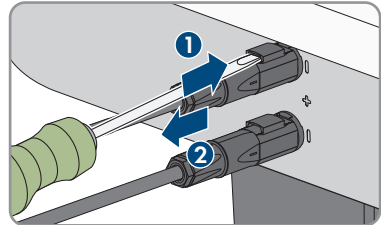

13. Ensure that no voltage is present at the DC inputs on the inverter using a suitable measuring device.

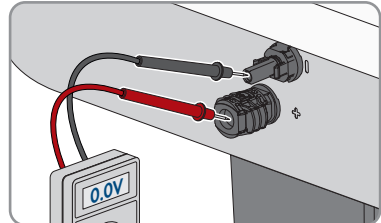

14. Loosen all ten screws of the enclosure lid (TX25) and remove the enclosure lid towards the front.

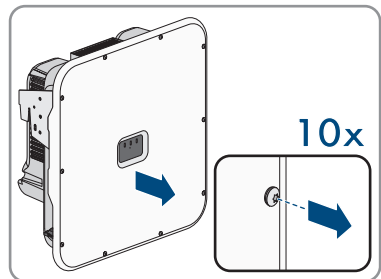

15. Set the screws and the enclosure lid aside and store safely.

16. Check that there is no voltage between L1 and N, L2 and N, and L3 and N at the AC terminal block for connecting the utility grid. Use a suitable measuring device for this purpose. To do this, insert the test probes through the openings on the terminal block.

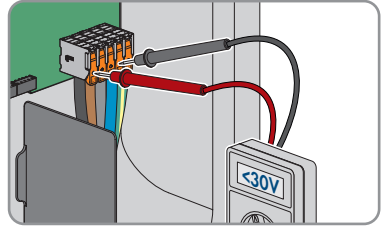

17. Check that there is no voltage between L1 and grounding conductor, L2 and grounding conductor, and L3 and grounding conductor at the AC terminal block for connecting the utility grid. Use a suitable measuring device for this purpose.

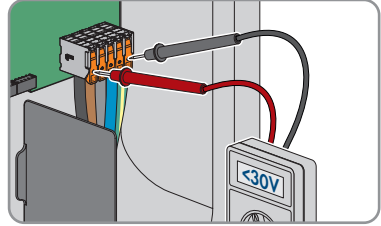

## 10 Cleaning

The product must be cleaned regularly to ensure that the product is free of dust, leaves and other dirt.

### NOTICE

#### **Damage to the product due to cleaning agents**

The use of cleaning agents may cause damage to the product and its components.

- Clean the product and all its components only with a cloth moistened with clear water.

# 11 Troubleshooting

## 11.1 Event messages

### 11.1.1 Event 101

#### QUALIFIED PERSON

**Event message:**

- Grid incident

**Explanation:**

The grid voltage or grid impedance at the connection point of the inverter is too high. The inverter has disconnected from the utility grid.

**Corrective measures:**

- Check whether the grid voltage at the connection point of the inverter is permanently in the permissible range.

If the grid voltage is outside the permissible range due to local grid conditions, contact the grid operator. The grid operator must agree with an adjustment of the voltage at the feed-in point or with a change of the monitored operating limits.

If the grid voltage is permanently within the permissible range and this message is still displayed, contact the Service.

### 11.1.2 Event 102

#### QUALIFIED PERSON

**Event message:**

- Grid incident

**Explanation:**

The grid voltage or grid impedance at the connection point of the inverter is too high. The inverter has disconnected from the utility grid.

**Corrective measures:**

- Check whether the grid voltage at the connection point of the inverter is permanently in the permissible range.

If the grid voltage is outside the permissible range due to local grid conditions, contact the grid operator. The grid operator must agree with an adjustment of the voltage at the feed-in point or with a change of the monitored operating limits.

If the grid voltage is permanently within the permissible range and this message is still displayed, contact the Service.



### 11.1.3 Event 103

#### QUALIFIED PERSON

**Event message:**

- Grid incident

**Explanation:**

The grid voltage or grid impedance at the connection point of the inverter is too high. The inverter has disconnected from the utility grid.

**Corrective measures:**

- Check whether the grid voltage at the connection point of the inverter is permanently in the permissible range.  
If the grid voltage is outside the permissible range due to local grid conditions, contact the grid operator. The grid operator must agree with an adjustment of the voltage at the feed-in point or with a change of the monitored operating limits.  
If the grid voltage is permanently within the permissible range and this message is still displayed, contact the Service.

### 11.1.4 Event 105

#### QUALIFIED PERSON

**Event message:**

- Grid incident

**Explanation:**

The grid voltage or grid impedance at the connection point of the inverter is too high. The inverter has disconnected from the utility grid.

**Corrective measures:**

- Check whether the grid voltage at the connection point of the inverter is permanently in the permissible range.  
If the grid voltage is outside the permissible range due to local grid conditions, contact the grid operator. The grid operator must agree with an adjustment of the voltage at the feed-in point or with a change of the monitored operating limits.  
If the grid voltage is permanently within the permissible range and this message is still displayed, contact the Service.

### 11.1.5 Event 301

#### QUALIFIED PERSON

**Event message:**

- Grid incident

**Explanation:**

The ten-minute average value of the grid voltage is no longer within the permissible range. The grid voltage or grid impedance at the connection point is too high. The inverter disconnects from the utility grid to maintain power quality.

**Corrective measures:**

- During the feed-in operation, check whether the grid voltage at the connection point of the inverter is permanently in the permissible range.

If the grid voltage is outside the permissible range due to local grid conditions, contact the grid operator. The grid operator must agree with an adjustment of the voltage at the feed-in point or with a change of the monitored operating limits.

If the grid voltage is permanently within the permissible range and this message is still displayed, contact the Service.

**11.1.6 Event 302****⚠ QUALIFIED PERSON****Event message:**

- Temperature AC voltage

**Explanation:**

The inverter has reduced its power due to a too-high grid voltage to ensure grid stability.

**Corrective measures:**

- If possible, check the grid voltage and observe how often fluctuations occur. If fluctuations occur frequently and this message is displayed often, contact the grid operator and request approval to change the operating parameters of the inverter. If the grid operator gives approval, discuss any changes to the operating parameters with the Service.

**11.1.7 Event 401****⚠ QUALIFIED PERSON****Event message:**

- Grid incident

**Explanation:**

The inverter has disconnected from the utility grid. A stand-alone grid or a very large change in the grid frequency was detected.

**Corrective measures:**

- Make sure there is no power outage or work being done on the utility grid and contact a grid operator if necessary.
- Check the grid connection for significant short-term frequency fluctuations.

### 11.1.8 Event 404

#### QUALIFIED PERSON

**Event message:**

- Grid incident

**Explanation:**

The inverter has disconnected from the utility grid. A stand-alone grid or a very large change in the grid frequency was detected.

**Corrective measures:**

- Make sure there is no power outage or work being done on the utility grid and contact a grid operator if necessary.
- Check the grid connection for significant short-term frequency fluctuations.

### 11.1.9 Event 501

#### QUALIFIED PERSON

**Event message:**

- Grid incident

**Explanation:**

The grid frequency is not within the permissible range. The inverter has disconnected from the utility grid.

**Corrective measures:**

- If possible, check the grid frequency and observe how often fluctuations occur.  
If fluctuations occur frequently and this message is displayed often, contact the grid operator and request approval to change the operating parameters of the inverter.  
If the grid operator gives approval, discuss any changes to the operating parameters with the Service.

### 11.1.10 Event 507

#### QUALIFIED PERSON

**Event message:**

- Temperature AC frequency

**Explanation:**

The inverter has reduced its power due to a too-high grid frequency to ensure grid stability.

**Corrective measures:**

- If possible, check the grid frequency and observe how often fluctuations occur. If fluctuations occur frequently and this message is displayed often, contact the grid operator and request approval to change the operating parameters of the inverter. If the grid operator gives approval, discuss any changes to the operating parameters with the Service.

### 11.1.11 Event 601

**⚠ QUALIFIED PERSON****Event message:**

- Grid incident

**Explanation:**

The inverter has detected an excessively high proportion of direct current in the grid current.

**Corrective measures:**

- Check the grid connection for direct current.
- If this message is displayed frequently, contact the grid operator and check whether the monitoring threshold on the inverter can be raised.

### 11.1.12 Event 701

**⚠ QUALIFIED PERSON****Event message:**

- Frequency not permitted
- Check parameter

**Explanation:**

The grid frequency is not within the permissible range. The inverter has disconnected from the utility grid.

**Corrective measures:**

- Check the AC wiring from the inverter to the feed-in meter.
- If possible, check the grid frequency and observe how often fluctuations occur. If fluctuations occur frequently and this message is displayed often, contact the grid operator and request approval to change the operating parameters of the inverter. If the grid operator gives approval, discuss any changes to the operating parameters with the Service.

### 11.1.13 Event 1001

#### QUALIFIED PERSON

**Event message:**

- L / N swapped

**Explanation:**

Incorrect installation of the L / N connection.

**Corrective measures:**

- Check the AC wiring from the inverter to the feed-in meter.
- Check the AC voltages on the inverter connection.
- If this message is still displayed, contact the Service.

### 11.1.14 Event 1101

#### QUALIFIED PERSON

**Event message:**

- Installation fault
- Check connection

**Explanation:**

A second line conductor is connected to N.

**Corrective measures:**

- Connect the neutral conductor to N.

### 11.1.15 Event 1302

#### QUALIFIED PERSON

**Event message:**

- Waiting for grid voltage
- Grid connection installation error
- Check grid connections and fuses

**Explanation:**

L or N not connected.

**Corrective measures:**

- Ensure that the line conductors are connected.
- Ensure that the miniature circuit breaker is switched on.
- Ensure that the AC cable is not damaged and that it is connected correctly.

### 11.1.16 Event 1501

#### QUALIFIED PERSON

**Event message:**

- Reconnection fault grid

**Explanation:**

The changed country standard or the value of a parameter you have set does not correspond to the local requirements. The inverter cannot connect to the utility grid.

**Corrective measures:**

- Ensure that the country standard has been configured correctly. To do this, select the parameter **Set country standard** and check the value.

### 11.1.17 Event 3501

#### QUALIFIED PERSON

**Event message:**

- Insulation failure
- Check generator

**Explanation:**

The inverter has detected a ground fault in the PV module.

**Corrective measures:**

- Check the PV system for ground faults.

### 11.1.18 Event 3601

#### QUALIFIED PERSON

**Event message:**

- High leakage current
- Check generator

**Explanation:**

The leakage current of the inverter and the PV module is too high. There is a ground fault, a residual current or a malfunction.

The inverter interrupts feed-in operation immediately after exceeding a threshold. When the fault is eliminated, the inverter automatically reconnects to the utility grid.

**Corrective measures:**

- Check the PV system for ground faults.

### 11.1.19 Event 3701

#### QUALIFIED PERSON

##### Event message:

- Residual current too high
- Check generator

##### Explanation:

The inverter has detected a residual current through brief grounding of the PV module.

##### Corrective measures:

- Check the PV system for ground faults.

### 11.1.20 Event 3901

#### QUALIFIED PERSON

##### Event message:

- Waiting for DC start conditions
- Start conditions not met

##### Explanation:

The feed-in conditions for the utility grid are not yet fulfilled.

##### Corrective measures:

- Ensure that the PV module is not covered by snow or otherwise shaded.
- Wait for higher irradiation.
- If this message is displayed frequently in the morning, increase the voltage limit for starting grid feed-in. Change the parameter **Critical voltage to start feed-in**.
- If this message is displayed frequently with medium irradiation, ensure that the PV module is correctly rated.

### 11.1.21 Event 3902

#### QUALIFIED PERSON

##### Event message:

- Waiting for DC start conditions
- Start conditions not met

##### Explanation:

The feed-in conditions for the utility grid are not yet fulfilled.

##### Corrective measures:

- Ensure that the PV module is not covered by snow or otherwise shaded.

- Wait for higher irradiation.
- If this message is displayed frequently in the morning, increase the voltage limit for starting grid feed-in. Change the parameter **Critical voltage to start feed-in**.
- If this message is displayed frequently with medium irradiation, ensure that the PV module is correctly rated.

### 11.1.22 Event 4301

#### QUALIFIED PERSON

##### Event message:

- Serial electric arc in string |s0| detected by AFCI module

##### Explanation:

The inverter has detected an electric arc in the displayed string. If "String N/A" is displayed, the string could not be uniquely assigned.

The inverter stops feeding into the utility grid.

##### Corrective measures:

- Disconnect the inverter from all voltage sources.
- Check the PV modules and the cabling in the affected string or, if the string was not displayed, in all strings for damage.
- Ensure that the DC connection in the inverter is correct.
- Repair or replace defective PV modules, DC cables or the DC connection in the inverter.
- Start manual restart (if necessary).

### 11.1.23 Event 6001-6499

#### QUALIFIED PERSON

##### Event message:

- Self-diagnosis
- Device fault

##### Explanation:

The cause must be determined by the Service.

##### Corrective measures:

- Contact Service.

### 11.1.24 Event 6501

#### QUALIFIED PERSON

##### Event message:

- Self-diagnosis



- Overtemperature

**Explanation:**

The inverter has switched off due to excessive temperature.

**Corrective measures:**

- Clean the cooling fins on the rear of the enclosure and the air ducts on the top using a soft brush.
- Ensure that the inverter has sufficient ventilation.
- Ensure that the inverter is not exposed to direct solar irradiation.
- Ensure the maximum ambient temperature is not exceeded.

### 11.1.25 Event 6511

**⚠ QUALIFIED PERSON****Event message:**

- Overtemperature

**Explanation:**

An overtemperature has been detected in the choke area.

**Corrective measures:**

- Clean the cooling fins on the rear of the enclosure and the air ducts on the top using a soft brush.
- Ensure that the inverter has sufficient ventilation.
- Ensure that the inverter is not exposed to direct solar irradiation.

### 11.1.26 Event 6512

**Event message:**

- Minimum operating temperature not reached

**Explanation:**

The inverter will only recommence grid feed-in once the temperature has reached at least  $-25^{\circ}\text{C}$ .

### 11.1.27 Event 6602

**⚠ QUALIFIED PERSON****Event message:**

- Overvoltage grid (AF)

**Explanation:**

The effective value of the grid voltage is above the permitted voltage threshold values for a specified period of time (AF limit).

**Corrective measures:**

- Check the grid voltage and connection on the inverter.  
If the grid voltage lies outside the permissible range due to local grid conditions, ask your grid operator if the voltage can be adjusted at the feed-in point or if it would be acceptable to change the monitored operating limits.

**11.1.28 Event 7001****⚠ QUALIFIED PERSON****Event message:**

- Fault sensor interior temperature

**Explanation:**

A temperature sensor in the inverter is defective and the inverter interrupts the feed-in operation. The cause must be determined by the Service.

**Corrective measures:**

- Contact Service.

**11.1.29 Event 7014****⚠ QUALIFIED PERSON****Event message:**

- **Fault boost converter temperature sensor**

**Explanation:**

Fan is always on.

**Corrective measures:**

- Contact Service.

**11.1.30 Event 7015****⚠ QUALIFIED PERSON****Event message:**

- Fault sensor interior temperature

**Explanation:**

A temperature sensor in the inverter is defective and the inverter interrupts the feed-in operation. The cause must be determined by the Service.

**Corrective measures:**

- Contact Service.

### 11.1.31 Event 7702

#### QUALIFIED PERSON

**Event message:**

- Self-diagnosis
- Interference device

**Explanation:**

The cause must be determined by the Service.

**Corrective measures:**

- Contact Service.

### 11.1.32 Event 7703

#### QUALIFIED PERSON

**Event message:**

- Self-diagnosis
- Interference device

**Explanation:**

The cause must be determined by the Service.

**Corrective measures:**

- Contact Service.

### 11.1.33 Event 7801

#### QUALIFIED PERSON

**Event message:**

- Fault overvoltage protector

**Explanation:**

One or more surge arresters have tripped or one or more surge arresters are not inserted correctly.

**Corrective measures:**

- Ensure that the surge arrester is inserted correctly.
- If surge arresters have tripped, replace the tripped surge arresters with new surge arresters.

### 11.1.34 Event 8501

#### QUALIFIED PERSON

**Event message:**

- Offset DC current sensor C.

**Corrective measures:**

- If this message is displayed again, contact the Service.

### 11.1.35 Event 8708

#### QUALIFIED PERSON

**Event message:**

- Timeout in communication for active power limitation

**Explanation:**

Communication to the system control absent. Depending on the fallback setting, either the last received values will be retained or the active power will be limited to the set percentage value of the inverter nominal power.

**Corrective measures:**

- Ensure that the connection to the System Manager is intact and that no cables are damaged or that no plugs have been pulled.

### 11.1.36 Event 8709

#### QUALIFIED PERSON

**Event message:**

- Timeout in communication for reactive power setpoint

**Explanation:**

Communication to the system control absent.

**Corrective measures:**

- Ensure that the connection to the System Manager is intact and that no cables are damaged or that no plugs have been pulled.

### 11.1.37 Event 8710

#### QUALIFIED PERSON

**Event number:**

- Timeout in communication for cos phi setpoint

**Explanation:**

Communication to the system control absent.

**Corrective measures:**

- Ensure that the connection to the System Manager is intact and that no cables are damaged or that no plugs have been pulled.

### 11.1.38 Event 9002

**⚠ QUALIFIED PERSON****Event message:**

- SMA Grid Guard code invalid

**Explanation:**

The SMA Grid Guard code entered is incorrect. The operating parameters are still protected and cannot be changed.

**Corrective measures:**

- Enter the correct SMA Grid Guard code.

### 11.1.39 Event 9003

**⚠ QUALIFIED PERSON****Event message:**

- Grid parameters locked

**Explanation:**

Changes to the grid parameters are now blocked.

**Corrective measures:**

- In order to be able to make changes to the grid parameters, you must be logged in as **Administrator** or **Installer** on the user interface. All changes to grid-relevant parameters should be coordinated with the grid operator.

### 11.1.40 Event 9007

**⚠ QUALIFIED PERSON****Event message:**

- Abort self-test

**Explanation:**

The self-test was terminated.

**Corrective measures:**

- Ensure that the AC connection is correct.
- Ensure that the country data set has been entered correctly.
- Restart the self-test.

**11.1.41 Event 9033****⚠ QUALIFIED PERSON****Event message:**

- Rapid shutdown has been triggered

**Explanation:**

The inverter detected the triggering of a Rapid Shutdown. The AC side of the inverter was disconnected.

**11.1.42 Event 9034****⚠ QUALIFIED PERSON****Event message:**

- Error in the rapid shutdown system

**Explanation:**

This message can have the following causes:

- The Rapid Shutdown Function was not correctly configured.
- The PV module could not be correctly disconnected. Voltage can be applied to the DC inputs of the inverter.
- The standby voltage of all PV module switches of a string is  $> 30$  V.

**Corrective measures:**

- Check the configuration of the Rapid Shutdown function and ensure that the operating mode selected is selected according to the DC disconnection unit used.
- Check the functionality of the PV module switches.
- Check the standby voltage of the PV module switches used and ensure that the standby voltage of all PV module switches of a string  $< 30$  V.

**11.1.43 Event 9035****⚠ QUALIFIED PERSON****Event message:**

- Rapid shutdown performed successfully

**Explanation:**

The voltage at the DC inputs and at the AC output of the inverter was successfully discharged.

### 11.1.44 Event 9038

#### QUALIFIED PERSON

**Event message:**

- Redundant rapid shutdown discharge function not assured

**Explanation:**

The cause must be determined by the Service.

**Corrective measures:**

- Contact Service.

## 11.2 Calculating the insulation resistance

The expected total resistance of the PV system or of an individual string can be calculated using the following formula:

The exact insulation resistance of a PV module can be obtained from the module manufacturer or the datasheet.  $\frac{1}{R_{\text{total}}} = \frac{1}{R_1} + \frac{1}{R_2} + \frac{1}{R_3} + \dots$

The exact insulation resistance of a PV module can be obtained from the module manufacturer or the datasheet.

For the resistance of a PV module an average value can be assumed: for thin-film PV modules approximately 40 MOhm and for polycrystalline and monocrystalline PV modules approximately 50 MOhm per PV module.

**Also see:**

- [Checking the PV System for Ground Faults](#) ⇒ page 96

## 11.3 Checking the PV System for Ground Faults

### ⚠ QUALIFIED PERSON

If the red LED is glowing and the event number 3501, 3601 or 3701 is being displayed in the **Results** menu on the inverter user interface, there may be a ground fault present. The electrical insulation from the PV system to ground is defective or insufficient.

### ⚠ DANGER

#### Danger to life due to electric shock when touching live system components in case of a ground fault

If a ground fault occurs, parts of the system may still be live. Touching live parts and cables results in death or lethal injuries due to electric shock.

- Disconnect the product from voltage sources and ensure it cannot be reconnected before working on the device.
- Only touch the cables of the PV modules on their insulation.
- Do not touch any parts of the substructure or frame of the PV array.
- Do not connect PV strings with ground faults to the inverter.

### ⚠ WARNING

#### Danger to life due to electric shock from destruction of the measuring device due to overvoltage

Overvoltage can damage a measuring device and result in voltage being present in the enclosure of the measuring device. Touching the live enclosure of the measuring device results in death or lethal injuries due to electric shock.

- Only use measuring devices with a DC input voltage range of 1000 V or higher.

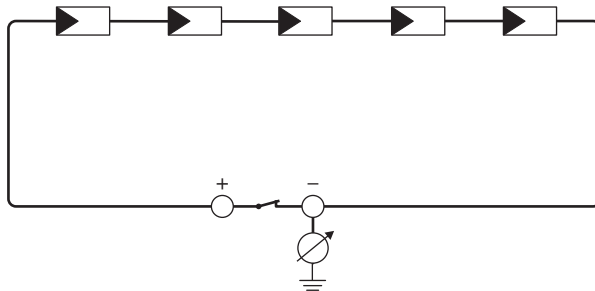

Figure 16: Schematic diagram of the measurement

#### Required equipment:

- Suitable device for safe disconnection and short-circuiting
- Measuring device for insulation resistance



### **i** Device required for safe disconnection and short-circuiting of the PV modules

The insulation resistance can only be measured with a suitable device for safe disconnection and short-circuiting of the PV modules. If no suitable device is available, the insulation measurement must not be carried out.

#### **Procedure:**

1. Calculate the expected insulation resistance per string.
2. Install the short circuit device.
3. Connect the measuring device for insulation resistance.
4. Short-circuit the first string.
5. Set the test voltage. The test voltage should be as close as possible to the maximum system voltage of the PV modules but must not exceed it (see datasheet of the PV modules).
6. Measure the insulation resistance.
7. Eliminate the short circuit.
8. Measure the remaining strings in the same manner.
  - ☑ If the insulation resistance of a string deviates considerably from the theoretically calculated value, there is a ground fault present in that string.
9. Reconnect to the inverter only those strings from which the ground fault has been eliminated.
10. Reconnect all other strings to the inverter.
11. Recommission the inverter.
12. If the inverter still displays an insulation error, contact the Service. The PV modules might not be suitable for the inverter in the present quantity.

#### **Also see:**

- [Calculating the insulation resistance](#) ⇒ page 95
- [Disconnecting the Inverter from Voltage Sources](#) ⇒ page 75

## **11.4 Cleaning the Fans**

If the inverter reduces its power due to overtemperature or even switches off, it is possible that the fan on the bottom of the inverter is no longer working properly due to contamination. Clean the fan as described in the following.

1. Disconnect the inverter from all voltage sources (see Section 9, page 75).

- Press the two locking tabs together to release the fan drawer and carefully pull the enclosure with the fan out downward.

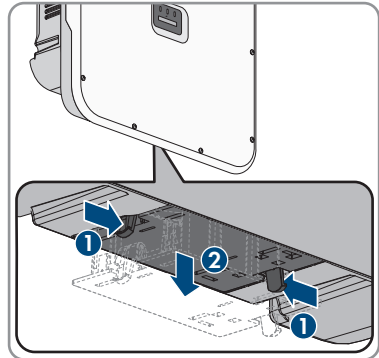

- Disconnect the fan connector in the unlocked state.

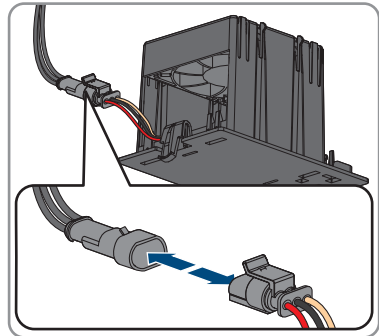

- Clean the fan assembly with a soft brush or a vacuum cleaner.
- Reinstall the serviced fan assembly in the inverter.
- Recommission the inverter (see Section 7.3, page 60).

## 11.5 Manual restart after electric arc

### ⚠ QUALIFIED PERSON

You can use the following parameter to resume feed-in operation after an electric arc has been detected.

Channel	Name	Settings
Operation.OpMod	General operating mode	Start

## 12 Decommissioning the Product

### QUALIFIED PERSON

To decommission the inverter completely upon completion of its service life, proceed as described in this Section.

### CAUTION

#### Risk of injury due to weight of product

Injuries may result if the product is lifted incorrectly or dropped while being transported or mounted.

- Transport and lift the product carefully. Take the weight of the product into account.
- Use the carrying handles or hoist when transporting the product. To attach the hoist system, eye bolts must be screwed into the threads provided, which are located on the right and left of the product's mounting lugs.
- Wear suitable personal protective equipment for all work on the product.

#### Procedure:

1. Disconnect the inverter from all voltage sources (see Section 9, page 75).

2.

### CAUTION

#### Risk of burns due to hot enclosure parts

- Wait 30 minutes for the enclosure to cool down.

3. If the DC terminal cover is present, disassemble the DC terminal cover. To do so, unscrew the M5x14 screws (TX25).
4. Remove the AC cable from the inverter. Press the locking levers all the way upward and pull the conductors out of the terminal blocks for the AC connection.
5. Press down the locking levers of the terminal blocks for the AC connection.
6. If additional grounding is connected, remove it.
7. If the multifunction relay is used, remove the connection cable from the inverter.
8. If other cables (e.g. network cables or signal cables) are connected, remove them from the inverter.
9. If a module is plugged in, remove it from the inverter.
10. Close the enclosure lid of the inverter.
11. If the inverter is protected against theft, open the padlock and remove it.
12. Unscrew the two M5x14 screws protecting the inverter from being lifted off with a screwdriver (TX25).
13. Remove the inverter by lifting it up and off the wall mounting bracket.
14. If the inverter is to be stored or shipped in packaging, pack the inverter. Use the original packaging or packaging that is suitable for the weight and dimensions of the inverter.

## 13 Disposal

The product must be disposed of in accordance with the locally applicable disposal regulations for waste electrical and electronic equipment.

**FR**

**Cet appareil  
et ses accessoires  
se recyclent**

REPRISE  
À LA LIVRAISON



OU

À DÉPOSER  
EN MAGASIN



OU

À DÉPOSER  
EN DÉCHÈTERIE



Points de collecte sur [www.quefairedemesdechets.fr](http://www.quefairedemesdechets.fr)  
Privilégiez la réparation ou le don de votre appareil !

## 14 Technical Data

### 14.1 General Data

Width x height x depth	728 mm x 762 mm x 266 mm
Weight	35 kg
Length x width x height of the packaging	800 mm x 880 mm x 400 mm
Transport weight	40.5 kg
Climatic category in accordance with IEC 60721-3-4	4K26
Environmental category	outdoors
Pollution degree of all enclosure parts	2
Operating temperature range	-25 °C to +60 °C
Max. permissible value for relative humidity (condensing)	100 %
Maximum operating altitude above mean sea level (MSL)	4000 m
Typical noise emission	59 dB(A)
Power loss in night mode	< 5 W
Topology	Transformerless (Non-isolated)
Cooling method	SMA OptiCool
Number of fans	3
Degree of protection for electronics in accordance with IEC 60529	IP65
Corrosivity classification according to IEC 61701 (at a minimum distance of 0.5 km (0.3 mile) from the coast)	C5
Protection class in accordance with IEC 62109-1	I
Radio technology	WLAN 802.11 b/g/n
Radio spectrum	2.4 GHz
Maximum transmission power	100 mW
Wi-Fi range in free-field conditions	10 m
Quantity maximum detectable Wi-Fi networks	32
Grid configurations	TN-C, TN-S, TN-C-S, TT (when $V_{N,PE} < 20$ V)

## 14.2 DC Input

	STP 12-50	STP 15-50	STP 20-50	STP 25-50
Maximum power of PV array	18000 W <sub>p</sub> STC	22500 W <sub>p</sub> STC	30000 W <sub>p</sub> STC	37500 W <sub>p</sub> STC
Maximum input voltage	1000 V	1000 V	1000 V	1000 V
MPP voltage range	210 V to 800 V	260 V to 800 V	345 V to 800 V	430 V to 800 V
Rated input voltage	580 V	580 V	580 V	580 V
Minimum input voltage	150 V	150 V	150 V	150 V
Initial input voltage	188 V	188 V	188 V	188 V
Maximum usable input current per input	24 A	24 A	24 A	24 A
Maximum short-circuit current per input <sup>3)</sup>	37.5 A	37.5 A	37.5 A	37.5 A
Maximum reverse current into the PV modules	0 A	0 A	0 A	0 A
Number of independent MPP inputs	3	3	3	3
Strings per MPP input	2	2	2	2
Overvoltage category as per IEC 62109-1	II	II	II	II

## 14.3 AC output

	STP 12-50	STP 15-50	STP 20-50	STP 25-50
Rated power at 230 V, 50 Hz	12000 W	15000 W	20000 W	25000 W

<sup>3)</sup> In accordance with IEC 62109-2:  $I_{SC, PV}$

	<b>STP 12-50</b>	<b>STP 15-50</b>	<b>STP 20-50</b>	<b>STP 25-50</b>
Maximum apparent power	12000 VA	15000 VA	20000 VA	25000 VA
Rated apparent power	12000 VA	15000 VA	20000 VA	25000 VA
Nominal grid voltage	220 V / 380 V, 230 V / 400 V, 240 V / 415 V	220 V / 380 V, 230 V / 400 V, 240 V / 415 V	220 V / 380 V, 230 V / 400 V, 240 V / 415 V	220 V / 380 V, 230 V / 400 V, 240 V / 415 V
Rated grid voltage	230 V	230 V	230 V	230 V
Voltage range <sup>4)</sup>	176 V to 275 V / 304 V to 477 V	176 V to 275 V / 304 V to 477 V	176 V to 275 V / 304 V to 477 V	176 V to 275 V / 304 V to 477 V
Rated current at 230 V	17.4 A	21.7 A	29.0 A	36.2 A
Maximum output current	20 A	25 A	36.6 A	36.6 A
Maximum output current under fault conditions	682.5 A <sub>peak</sub> / 10 ms	682.5 A <sub>peak</sub> / 10 ms	682.5 A <sub>peak</sub> / 10 ms	682.5 A <sub>peak</sub> / 10 ms
Total harmonic distortion of the output current with total harmonic distortion of the AC voltage <2%, and AC power >50% of the rated power	< 3 %	< 3 %	< 3 %	< 3 %
Inrush current	< 10% of the nominal AC current for a maximum of 10 ms	< 10% of the nominal AC current for a maximum of 10 ms	< 10% of the nominal AC current for a maximum of 10 ms	< 10% of the nominal AC current for a maximum of 10 ms
Rated grid frequency	50 Hz	50 Hz	50 Hz	50 Hz
Grid frequency <sup>4)</sup>	50 Hz / 60 Hz	50 Hz / 60 Hz	50 Hz / 60 Hz	50 Hz / 60 Hz
Operating range at grid frequency 50 Hz	44 Hz to 56 Hz	44 Hz to 56 Hz	44 Hz to 56 Hz	44 Hz to 56 Hz

<sup>4)</sup> Depending on the configured country data set

	STP 12-50	STP 15-50	STP 20-50	STP 25-50
Operating range at grid frequency 60 Hz	54 Hz to 66 Hz	54 Hz to 66 Hz	54 Hz to 66 Hz	54 Hz to 66 Hz
Power factor at rated power	1	1	1	1
Displacement to power factor, adjustable	0.0 overexcited to 0.0 underexcited	0.0 overexcited to 0.0 underexcited	0.0 overexcited to 0.0 underexcited	0.0 overexcited to 0.0 underexcited
Feed-in phases	3	3	3	3
Connection phases	3-(N)-PE	3-(N)-PE	3-(N)-PE	3-(N)-PE
Overvoltage category as per IEC 62109-1	III	III	III	III

## 14.4 Digital inputs

### Digital inputs

Quantity	6
Input voltage	12 V DC
Maximum cable length	100 m

## 14.5 Digital output (multifunction relay)

Quantity	1
Execution	Potential-free relay contacts
Maximum switching voltage	30 V <sub>DC</sub>
Maximum switching current	1 A
Minimum switching current	10 mA
Minimum electrical endurance when the maximum switching voltage and maximum switching current are complied with <sup>5)</sup>	100000 switching cycles
Bounce time	5 ms
Reset time	5 ms
Maximum cable length	100 m

<sup>5)</sup> Corresponds to 20 years at 12 switching operations per day



## 14.6 Communication

SMA devices	Max. 5 inverters with SMA Speedwire and 1 energy meter, 100 Mbit/s
I/O systems and meters	Ethernet, 10/100 Mbit/s, Modbus TCP

## 14.7 Data Storage Capacity

1-minute values	7 days
5-minute values	7 days
15-minute values	30 days
60-minute values	3 years
Event messages	1024 events

## 14.8 Efficiency

	STP 12-50	STP 15-50	STP 20-50	STP 25-50
Maximum efficiency, $\eta_{\max}$	98.2 %	98.2 %	98.2 %	98.2 %
European weighted efficiency, $\eta_{\text{EU}}$	97.6 %	97.8 %	97.9 %	98 %

## 14.9 Protective Devices

DC reverse polarity protection	Short-circuit diode
Input-side disconnection point	DC load-break switch
DC overvoltage protection	Surge arrester type 1+2 or type 2 (optional)
AC short-circuit current capability	Current control
Grid monitoring	SMA Grid Guard 10.0
Maximal output overcurrent protection	50 A
Ground fault monitoring	Insulation monitoring: $R_{\text{iso}} > 100 \text{ k}\Omega$
All-pole sensitive residual-current monitoring unit	Available
SMA ArcFix arc-fault circuit interrupter	Available
Active anti-islanding method	Frequency shift

## 14.10 Climatic Conditions

### Installation in accordance with IEC 60721-3-4, Class 4K26

Extended temperature range	-25°C to +60°C
Extended humidity range	0% to 100%
Threshold for relative humidity, non-condensing	100 %
Extended air pressure range	79.5 kPa to 106 kPa

### Transport in accordance with IEC 60721-3-4, Class 2K12

Temperature range	-40°C to +70°C
-------------------	----------------

## 14.11 Equipment

DC connection	SUNCLIX DC connector
AC connection	Spring-cage terminals
Digital output (multifunction relay)	As standard
Digital inputs, DI 5-7	As standard
DC surge protection devices type 1+2 and 2 or type 2	Optional

## 14.12 Torques

Screws for protecting the inverter from being lifted (M5x14)	1.5 Nm
SUNCLIX swivel nut	2 Nm
Screws for additional grounding (TX25)	4 Nm
Enclosure lid screws (TX25)	6 Nm ± 0.5 Nm

## 15 Accessories

You will find the accessories for your product in the following overview. If required, these can be ordered from SMA Solar Technology AG or your distributor.

Accessories	SMA order number
DC overvoltage protection type 1+2	DC_SPD_KIT7_T1T2
DC overvoltage protection as accessory for Sunny Tripower X PV inverter consisting of base incl. connection cable and connected surge arresters type 1+2	
DC overvoltage protection type 2	DC_SPD_KIT6-10
DC overvoltage protection as accessory for Sunny Tripower X PV inverter consisting of base incl. connection cable and connected surge arresters type 2	
DC terminal cover	DC-TERM-COVER
DC connection cover as accessory for Sunny Tripower X solar inverter consisting of enclosure, cover and mounting material	
SMA Sensor Module	MD.SEN-40 <sup>6)</sup>
SMA Sensor Module with interfaces for the connection of different sensors as accessories for Sunny Tripower X and Sunny Tripower CORE1 consisting of module, mounting material and terminal blocks	

<sup>6)</sup> Compatible from hardware version A3 with the Sunny Tripower X

## 16 Contact

If you have technical problems with our products, please contact the SMA Service Line. The following data is required in order to provide you with the necessary assistance:

- Device type
- Serial number
- Firmware version
- Device configuration (System Manager or subordinate device)
- Special country-specific settings (if available)
- Event message
- Mounting location and mounting height
- Type and number of PV modules
- Optional equipment (e.g. accessories used)
- Use the name of the system in Sunny Portal (if available)
- Access data for Sunny Portal (if available)
- Information on the ripple control receiver (if available)
- Operating mode of the multifunction relay (if used)
- Detailed description of the problem

You can find your country's contact information at:



<https://go.sma.de/service>

## 17 EU Declaration of Conformity

within the scope of the EU directives

- Radio Equipment Directive 2014/53/EU (22.5.2014 L 153/62) (RED)
- Restriction of the use of certain hazardous substances 2011/65/EU (L 174/88, June 8, 2011) and 2015/863/EU (L 137/10, March 31, 2015) (RoHS)



SMA Solar Technology AG confirms herewith that the products described in this document are in compliance with the fundamental requirements and other relevant provisions of the aforementioned directives. More information on the availability of the entire declaration of conformity can be found at <https://www.sma.de/en/ce-ukca>.

Radio technology	WLAN 802.11 b/g/n
Radio spectrum	2.4 GHz
Maximum transmission power	100 mW

## 18 UK Declaration of Conformity

according to the regulations of England, Wales and Scotland

- Electromagnetic Compatibility Regulations 2016 (SI 2016/1091)
- Electrical Equipment (Safety) Regulations 2016 (SI 2016/1101)
- Radio Equipment Regulations 2017 (SI 2017/1206)
- The Restriction of the Use of Certain Hazardous Substances in Electrical and Electronic Equipment Regulations 2012 (SI 2012/3032)



SMA Solar Technology AG confirms herewith that the products described in this document are in compliance with the fundamental requirements and other relevant provisions of the above-mentioned regulations. More information on the availability of the entire declaration of conformity can be found at <https://www.sma.de/en/ce-ukca>.

Radio technology	WLAN 802.11 b/g/n
Radio spectrum	2.4 GHz
Maximum transmission power	100 mW

### SMA Solar UK Ltd.

Countrywide House  
23 West Bar, Banbury  
Oxfordshire, OX16 9SA  
United Kingdom





[www.SMA-Solar.com](http://www.SMA-Solar.com)

