

Blue Smart IP22 Charger

12/15, 12/20, 12/30, 24/8, 24/12, 24/16 | 1 & 3 Output |
230V

Rev. 02 - 03/2024

This manual is also available in [HTML5](#).

Table of Contents

1. Safety instructions	1
2. Quick start guide	2
3. Features	5
4. Operation	7
4.1. Charge algorithm	7
4.2. Charge modes	9
4.2.1. Charge voltage	9
4.2.2. Recondition mode	9
4.2.3. Low current mode	10
4.2.4. Night mode	10
4.3. Temperature compensation	11
4.4. VE.Smart Networking	12
4.4.1. Voltage sense	12
4.4.2. Temperature sense	12
4.4.3. Current sense	13
4.4.4. Synchronised charging	13
4.5. Commencing a new charge cycle	14
4.6. Estimating charge time	15
4.6.1. Lead-acid based chemistry	15
4.6.2. Li-ion based chemistry	15
4.7. Multiple isolated outputs	16
5. Installation	17
5.1. Mounting	17
5.2. Wiring	18
5.2.1. DC Power cable	18
5.2.2. Overcurrent protection	20
5.3. Schematics	21
5.3.1. Basic installation	21
5.3.2. VE.Smart Networking	23
5.3.3. Multiple chargers	27
6. Setup	28
6.1. Setup using the charger	28
6.2. Setup using Bluetooth	29
6.3. Bluetooth	32
6.3.1. Changing the PIN code	32
6.3.2. Resetting the PIN code	34
6.3.3. Disabling Bluetooth	36
6.3.4. Re-enabling Bluetooth	38
6.4. Reset to defaults	39
7. Monitoring	40
7.1. LED indications	40
7.1.1. Operation states	40
7.2. VictronConnect	41
7.2.1. Status screen	41
7.2.2. Graph screen	42
7.2.3. History screen	43
8. Advanced Configuration	45
8.1. Advanced settings	45
8.2. Expert mode settings	48
8.3. VE.Smart Networking	51
8.3.1. Voltage, temperature and current sense	51
8.3.2. Synchronised charging	56
8.4. Power supply mode	60

9. Technical specifications 61

10. Warranty 62

1. Safety instructions



WARNING: CAREFULLY READ AND FOLLOW ALL SAFETY INSTRUCTIONS

- Carefully read the manual **before** the charger is installed and operated; retain the manual in a safe place for future reference.
- The charger must **not** be installed or operated by any of the following persons, unless they are under strict instruction and supervision:
 - a. Anyone who lacks the appropriate knowledge, experience or competence, required for safe installation and/or usage.
 - b. Anyone with compromised/reduced physical, sensory or mental capabilities, which may effect safe installation and/or usage (including children).
- **Charger installation and operation**
 - a. Install the charger in a location with good natural airflow/ventilation and sufficient unobstructed space around it; refer to the the 'Installation' section for more detail.
 - b. Install the charger on a non-flammable substrate and ensure there are no heat-sensitive items in the immediate vicinity; it is normal for the charger to become hot during operation.
 - c. Install the charger in a location where it is protected from environmental conditions such as water, moisture, dust and direct sunlight.
 - d. Do not install or operate the charger in a location where it may be exposed to flammable gasses or liquids, such as directly above the battery, or in a sealed compartment with the battery; batteries can emit explosive gasses.
 - e. Do not cover or place any other items on top of the charger.
- **Battery installation and charging**
 - a. Install and charge the battery in a location with good natural airflow/ventilation.
 - b. Ensure that there are no ignition sources near the battery; batteries can emit explosive gasses.
 - c. Battery acid is corrosive; if battery acid comes into contact with skin immediately rinse with water.
 - d. Do not charge non-rechargeable batteries or Li-ion batteries if the battery temperature is below 0°C.
- **Battery DC connection**
 - a. Ensure that the DC system is fully shut down/isolated prior to disconnection of any existing cabling and/or new connections are made to the battery/DC system.
 - b. Use flexible multi stranded copper DC power cable with sufficient cross sectional area, inline with an appropriate fuse or circuit breaker; refer to the 'Installation > Wiring' section for more information.
- **Mains supply AC connection**
 - a. AC connection to the mains supply must be in accordance with local electrical regulations. The charger must be plugged into an earthed AC mains power outlet.
 - b. Do not operate the charger if the AC power cable is damaged, contact a service agent.
- **Charger setup**
 - a. Refer to the battery manufacturers instructions and specifications to ensure the battery is suitable for use with this charger and confirm the recommended charge settings.
 - b. The integrated charge modes (selected via the charger or Bluetooth) combined with adaptive charge logic are well suited for most common battery types; such as flooded lead-acid, AGM, Gel and LiFePO4.
If necessary, advanced configuration with user defined settings is also possible using a Bluetooth enabled device (such as a mobile phone or tablet) with the VictronConnect app.

2. Quick start guide

1. Mount the **Blue Smart IP22 Charger** vertically (with terminals facing down) on a non-flammable substrate; secure using the 4 mounting holes on the base. Ensure there is at least 10cm of clearance below and above the charger for airflow/cooling.
2. Connect DC power cabling between the **Blue Smart IP22 Chargers BATTERY** terminals (located under the bottom cover) and the battery or DC system distribution bus.

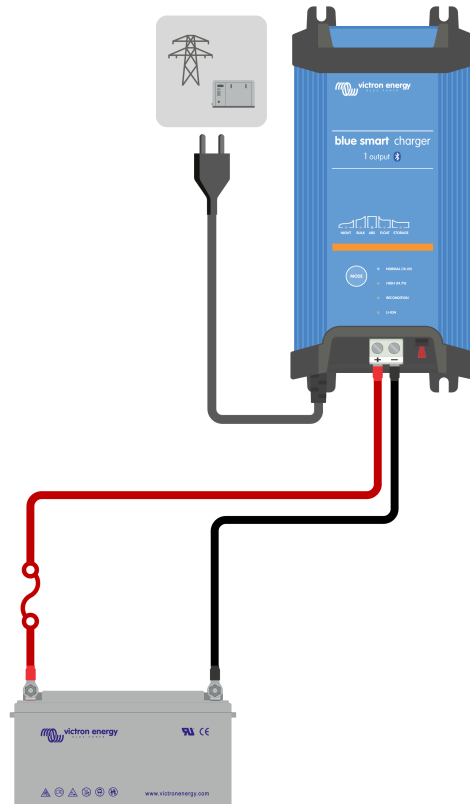

- a. Ensure that the DC system is fully shut down (all DC loads and charge sources off/isolated) prior to disconnection of any existing battery/DC system distribution bus cabling and connection of the charger to the battery terminals/DC system distribution bus.
- b. Use flexible multi stranded copper DC power cable with sufficient cross sectional area, inline with an appropriate fuse or circuit breaker.
- c. Ensure that wiring polarity is correct; use red cabling for the + (positive) connections and black cabling for the - (negative) connections.
- d. Torque the terminal screws to 2.4Nm using a small torque wrench with a suitable screw driver bit, and reinstall the lower connection cover.

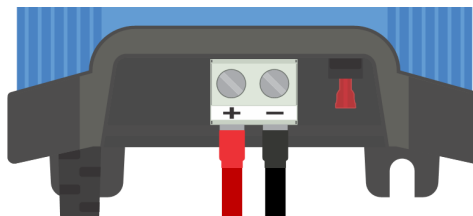

3. Connect the AC power cable to a mains power outlet; after a short delay, the LEDs indicating the current charge mode and charge state will illuminate.



4. Select the charge mode and charge current limit most appropriate for the battery type and capacity.

a. **Setup using the charger:**

- i. Select the most appropriate mode from the integrated charge presets (Normal, Normal + Recondition, High, High + Recondition or Li-ion) by briefly pressing the MODE button on the charger to cycle through each option; the LED beside the currently selected charge mode (NORMAL / HIGH / LI-ION) will be illuminated, as well as the RECONDITION LED if enabled.

Ensure that recondition stage is only enabled when required, as unnecessary or overuse will reduce battery life.

- ii. If required, enable low current mode (charge current limited to 50% of the maximum rated charge current and disabled fan); to enable (or disable) low current mode depress and hold the MODE button for 6 seconds, when enabled the NIGHT LED will blink.

Alternatively night mode can be enabled, which temporarily activates low current mode for a period of 8 hours (typically overnight to eliminate fan noise); to enable (or disable) night mode depress and hold the MODE button for 3 seconds, when enabled the NIGHT LED will be illuminated.

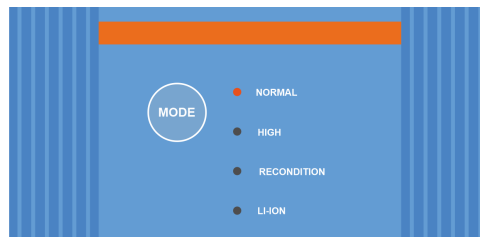

b. **Setup using Bluetooth:**

- i. Using a Bluetooth enabled device (such as a mobile phone or tablet), open the **VictronConnect** app and locate the **Blue Smart IP22 Charger** in the LOCAL page, then connect to the device (default Bluetooth PIN Code is 000000).

- ii. Select the 'Setting' icon (gear in the top right corner) to access the 'Settings' page.

- iii. Select the most appropriate mode from the integrated charge presets (Normal, Normal + Recondition, High, High + Recondition or Li-ion) in the 'Charge preset' menu; the LED beside the currently selected charge mode (NORMAL / HIGH / LI-ION) will be illuminated, as well as the RECONDITION LED if recondition stage is enabled.

Ensure that recondition stage is only enabled when required, as unnecessary or overuse will reduce battery life.

- iv. If required, enable low current mode (charge current limited to 50% of the maximum rated charge current and disabled fan); to enable (or disable) low current mode select the required option from the 'Charge current' menu, when enabled the NIGHT LED will blink.

Alternatively night mode can be enabled, which temporarily activates low current mode for a period of 8 hours (typically overnight to eliminate fan noise); to enable (or disable) night mode toggle the 'Night mode' switch on (or off to disable), when enabled the NIGHT LED will illuminate.

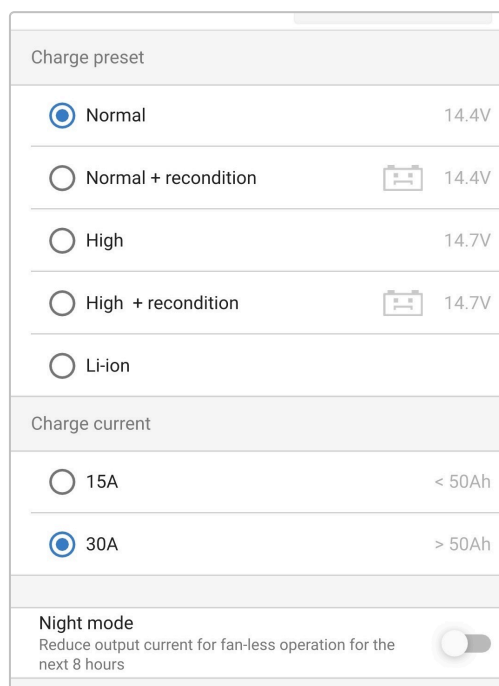

The charger will automatically store the selected charge mode and recall it for future charge cycles (even after being disconnected from power).

5. When the ABS LED is illuminated the charger has moved into absorption stage (bulk stage is complete); the battery will be approximately 80% charged (or >95% for Li-ion batteries) and may be returned into service if required.
6. When the FLOAT LED is illuminated the charger has moved into float stage (absorption stage is complete); the battery will be fully (100%) charged and is ready to be returned into service.
7. When the STORAGE LED is illuminated the charger has moved into storage mode (float stage is concluded); to maintain the battery at full charge, the battery can be left on continuous charge for an extended duration.
8. To stop charging isolate the power supply to the AC power cable.

3. Features

a. Bluetooth setup and monitoring (Using VictronConnect)

Equipped with integrated Bluetooth; enabling quick and simple setup, advanced configuration, comprehensive monitoring and firmware updates via the **VictronConnect** app and a Bluetooth enabled device (such as a mobile phone or tablet).

b. VE.Smart Network compatible

VE.Smart Networking capability allows multiple chargers to operate in unison with synchronised charging, and receive accurate battery voltage (Voltsense), charge current (Current-sense) and battery temperature (Temp-sense) data from a compatible battery monitor (such as a BMV, SmartShunt, Smart Battery Sense or VE.Bus Smart Dongle) to further enhance the charge cycle.

c. Integrated charge presets

Integrated charge presets (selected via the MODE button or VictronConnect app) combined with adaptive charge logic are well suited for most common battery types; such as LiFePO₄, AGM, Gel and flooded lead-acid. Advanced configuration with specific user defined settings is also possible using VictronConnect.

d. Multi-stage charge algorithm

The multi-stage charge algorithm is specifically engineered to optimise each recharge cycle and charge maintenance over extended periods.

e. Adaptive absorption

Adaptive absorption monitors the battery's response during initial charging and intelligently determines the appropriate absorption duration for each individual charge cycle. This ensures that the battery is fully recharged regardless of the discharge level or capacity and avoids excessive time at the elevated absorption voltage (that can accelerate battery aging).

f. Temperature compensation

Charge voltage is automatically compensated depending on the ambient temperature; this ensures that the battery is charged at the optimal charge voltage regardless of the climate and avoids the need for manual settings adjustments. Temperature compensation is not required and automatically disabled when in LI-ION charge mode.

g. High efficiency

The **Blue Smart IP22 Charger** range is up to ~94% efficient; resulting in lower power usage, less heat generated and cooler operation

h. Durable and safe

- i. Engineered to provide years of trouble-free and dependable operation in all usage conditions
- ii. Protection against overheating: output current will be reduced if the charger temperature increases above 40°C (linear derate from 100% at 40°C to 20% at 60°C)
- iii. Protection against output short circuit: If a short circuit condition is detected the charger will shut down
- iv. Protection against reverse polarity connection: If the charger is incorrectly connected to a battery with reverse polarity the user replaceable fuse will blow

i. Silent operation

Charger operation is totally silent whilst the cooling fan is off; the cooling fan is only activated when it is necessary during demanding periods. If the NIGHT or LOW current mode is activated; the maximum output current is reduced to 50% of nominal and the cooling fan will remain off.

j. Lithium Ion compatible

Compatible with Li-ion (LiFePO₄) batteries; when the integrated LI-ION charge mode is selected the charge cycle settings are altered to suit.

If the charger is connected to a battery where under voltage protection (UVP) has tripped, it will automatically reset UVP and start charging; many other chargers will not recognise a battery in this state.

Warning: Do not charge Li-ion batteries if the battery temperature is below 0°C.

k. Storage stage

An additional stage to extend battery life whilst the battery is unused and on continuous charge.

l. Recondition stage

An optional stage that can partially recover/reverse lead acid battery degradation due to sulfation; typically caused by inadequate charging or if the battery is left in a deeply discharged state.

m. **Configurable output current**

A fully configurable setting that limits the maximum charge current to a reduced level; beneficial when charging lower capacity batteries with a high current charger.

n. **Recovery function**

The charger will attempt to recharge a severely discharged battery (even down to 0V) with low current and then resume normal charging once the battery voltage has risen sufficiently; many other chargers will not recognise a battery in this state.

o. **Power supply mode**

A specific mode to use the charger as a DC power supply; to power equipment at a constant voltage with or without a battery connected.

4. Operation

4.1. Charge algorithm

The **Blue Smart IP22 Charger** range are intelligent multi-stage battery chargers, specifically engineered to optimise each recharge cycle and charge maintenance over extended periods.

The multi-stage charge algorithm includes the individual charge stages described below:

1. Bulk

The battery is charged at maximum charge current until the voltage increases to the configured absorption voltage.

The bulk stage duration is dependent on the battery's level of discharge, the battery capacity and the charge current.

Once the bulk stage is complete, the battery will be approximately 80% charged (or >95% for Li-ion batteries) and may be returned into service if required.

2. Absorption

The battery is charged at the configured absorption voltage, with the charge current slowly decreasing as the battery approaches full charge.

The default absorption stage duration is adaptive and intelligently varied depending on the battery's level of discharge (determined from the duration of the bulk charge stage).

Adaptive absorption stage duration can vary between a minimum of 30 minutes, up to a maximum limit of 8 hours (or as configured) for a deeply discharged battery.

Alternatively, fixed absorption duration can be selected; fixed absorption duration is the automatic default when Li-ion mode is selected.

Absorption stage can also be ended early based on the tail current condition (if enabled), which is when the charge current drops below the tail current threshold.

3. Recondition

The battery voltage is attempted to be increased to the configured recondition voltage, while the charger output current is regulated to 8% of the nominal charge current (for example: 1.2A maximum for a 15A charger).

Recondition is an optional charge stage for lead acid batteries and not recommended for regular/cyclic use; use only if required, as unnecessary or overuse will reduce battery life due to excessive gassing.

The higher charge voltage during recondition stage can partially recover/reverse battery degradation due to sulfation, typically caused by inadequate charging or if the battery is left in a deeply discharged state for an extended period (if performed in time).

The recondition stage may also be applied to flooded batteries occasionally to equalise individual cell voltages and prevent acid stratification.

Recondition stage is terminated as soon as the battery voltage increases to the configured recondition voltage or after a maximum duration of 1 hour (or as configured).

Note that in certain conditions it is possible for the recondition state to end before the configured recondition voltage is achieved, such as when the charger is simultaneously powering loads, if the battery was not fully charged before recondition stage commenced, if the recondition duration is too short (set to less than one hour) or if the charger output current is insufficient in proportion to the capacity of the battery/battery bank.

4. Float

The battery voltage is maintained at the configured float voltage to prevent discharge.

Once float stage is commenced the battery is fully charged and ready for use.

The float stage duration is also adaptive and varied between 4 to 8 hours depending on the duration of the absorption charge stage, at which point the charger determines the battery to be in storage stage.

5. Storage

The battery voltage is maintained at the configured storage voltage, which is slightly reduced compared to the float voltage to minimise gassing and extend battery life whilst the battery is unused and on continuous charge.

6. Repeated absorption

To refresh the battery and prevent slow self-discharge while in storage stage over an extended period, a 1 hour absorption charge will automatically occur every 7 days (or as configured).

The indicator LEDs display the active charge state; refer to the image below:

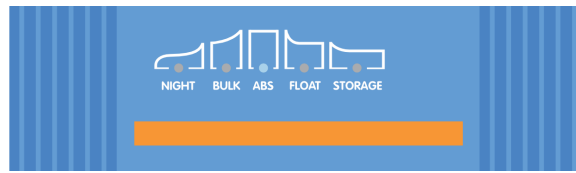

Alternatively, a Bluetooth enabled device (such as a mobile phone or tablet) with the VictronConnect app can be used to view the active charge state; refer to the 'Monitoring > VictronConnect > Status' and 'Monitoring > VictronConnect > Graph' sections for more information.

4.2. Charge modes

There are 3 integrated charge modes (Normal, High and Li-Ion), as well as an optional Recondition stage that can be included (except for Li-ion mode).

The integrated charge modes combined with adaptive charge logic are well suited for most common battery types; such as flooded lead-acid, AGM, Gel and LiFePO4.

The required charge mode can be selected via the MODE button on the charger or a Bluetooth enabled device (such as a mobile phone or tablet) with the VictronConnect app; refer to the 'Setup > Setup using the charger' or 'Setup > Setup using Bluetooth' section for more information.

If necessary, advanced configuration with user defined settings is also possible using a Bluetooth enabled device (such as a mobile phone or tablet) with the VictronConnect app; refer to the 'Advanced configuration > Advanced settings' and 'Advanced configuration > Expert mode settings' sections for more information.

Any settings made are stored and will not be lost when the charger is disconnected from mains power or the battery.

4.2.1. Charge voltage

The charge voltage settings for each charge stage are altered depending on integrated charge mode selected; refer to the table below:

Mode	Absorption		Float		Storage		Recondition	
	12V	24V	12V	24V	12V	24V	12V	24V
Normal	14.4V	28.8V	13.8V	27.6V	13.2V	26.4V	Disabled	
Normal + Recondition	14.4V	28.8V	13.8V	27.6V	13.2V	26.4V	16.2V	32.4V
High	14.7V	29.4V	13.8V	27.6V	13.2V	26.4V	Disabled	
High + Recondition	14.7V	29.4V	13.8V	27.6V	13.2V	26.4V	16.5V	33.0V
Li-ion	14.2V	28.4V	Disabled		13.5V	27.0V	Disabled	



To ensure proper charging, battery longevity and safe operation it is important to select a charge mode appropriate for the battery type and capacity being charged; refer to the battery manufacturer's recommendations.

The **Blue Smart IP22 Charger** range feature temperature compensation, which will automatically optimise the nominal/configured charge voltage based on ambient temperature (except for Li-ion mode or if manually disabled); refer to the 'Operation > Temperature compensation' section for more information.

4.2.2. Recondition mode

If enabled the recondition stage is included in the charge cycle; use only if required as a corrective/maintenance action - refer to the 'Operation > Charge algorithm' section for more information.

When the recondition mode is enabled the RECONDITION LED will be illuminated and blink during recondition stage.

Recondition mode can be enabled and disabled via the MODE button on the charger or a Bluetooth enabled device (such as a mobile phone or tablet) with the VictronConnect app; refer to the 'Setup > Setup using the charger' or 'Setup > Setup using Bluetooth' section for more information.

4.2.3. Low current mode

If enabled the maximum charge current is limited to 50% of the maximum rated charge current (refer to 'Technical Specifications' section for more information) and the cooling fan will be disabled.

Low current mode is recommended when charging lower capacity batteries with a high current charger; charging at an excessive charge current can cause premature battery degradation and overheating.

Typically the maximum charge current for lead acid based batteries should not exceed $\sim 0.3C$ (more than 30% of the battery capacity in Ah) and the maximum charge current for LiFePO4 batteries should not exceed $\sim 0.5C$ (more than 50% of the battery capacity in Ah).

When low current mode is enabled the NIGHT LED will blink.

Low current mode can be enabled and disabled via the MODE button on the charger or a Bluetooth enabled device (such as a mobile phone or tablet) with the VictronConnect app; refer to the 'Setup > Setup using the charger' or 'Setup > Setup using Bluetooth' section for more information.



It is also possible to set the charge current limit to a user defined value between the maximum rated charge current and the minimum charge current limit (25% of maximum) using a Bluetooth enabled device (such as a mobile phone or tablet) with the VictronConnect app; refer to the 'Advanced Configuration > Advanced settings' section for more information.

When the charge current limit is set to or below 50% of the maximum rated charge current the NIGHT LED will blink.

4.2.4. Night mode

If enabled the maximum charge current is limited to 50% of the maximum rated charge current and the cooling fan will be disabled for a period of 8 hours (typically overnight).

Once 8 hours have elapsed or if the charger is disconnected from mains power, night mode will be disabled and the charger will return to normal operation with maximum rated charge current available, and cooling fan operation enabled.

Night mode is particularly useful to provide a period of totally silent operation when charging overnight.

When night mode is enabled the NIGHT LED will be illuminated.

Night mode can be enabled and disabled via the MODE button on the charger or a Bluetooth enabled device (such as a mobile phone or tablet) with the VictronConnect app; refer to the 'Setup > Setup using the charger' and 'Setup > Setup using Bluetooth' section for more information.

4.3. Temperature compensation

The **Blue Smart IP22 Charger** range feature temperature compensation, which will automatically optimise the nominal/ configured charge voltage based on ambient temperature (except for Li-ion mode or if manually disabled).

The optimal charge voltage of a lead-acid battery varies inversely with battery temperature; automatic temperature-based charge voltage compensation avoids the need for special charge voltage settings in hot or cold environments.

During power up the charger will measure its internal temperature and use that temperature as the reference for temperature compensation, however the initial temperature measurement is limited to 25°C as it's unknown if the charger is still warm from earlier operation.

Since the charger generates some heat during operation, the internal temperature measurement is only used dynamically if the internal temperature measurement is considered reliable; when the charge current has decreased to a low/negligible level and adequate time has elapsed for the charger's temperature to stabilise.

For more accurate temperature compensation, battery temperature data can be sourced from a compatible battery monitor (such as a BMV, SmartShunt, Smart Battery Sense or VE.Bus Smart Dongle) via VE.Smart Networking; refer to the 'Operation > VE.Smart Networking' section for more information.

The configured charge voltage is related to a nominal temperature of 25°C and linear temperature compensation occurs between the limits of 6°C and 50°C based on the default temperature compensation coefficient of -16.2mV/°C for 12V chargers (-32.4mV/°C for 24V chargers) or as configured.

Refer to the graph below for the default temperature vs charge voltage curve for 12V chargers:

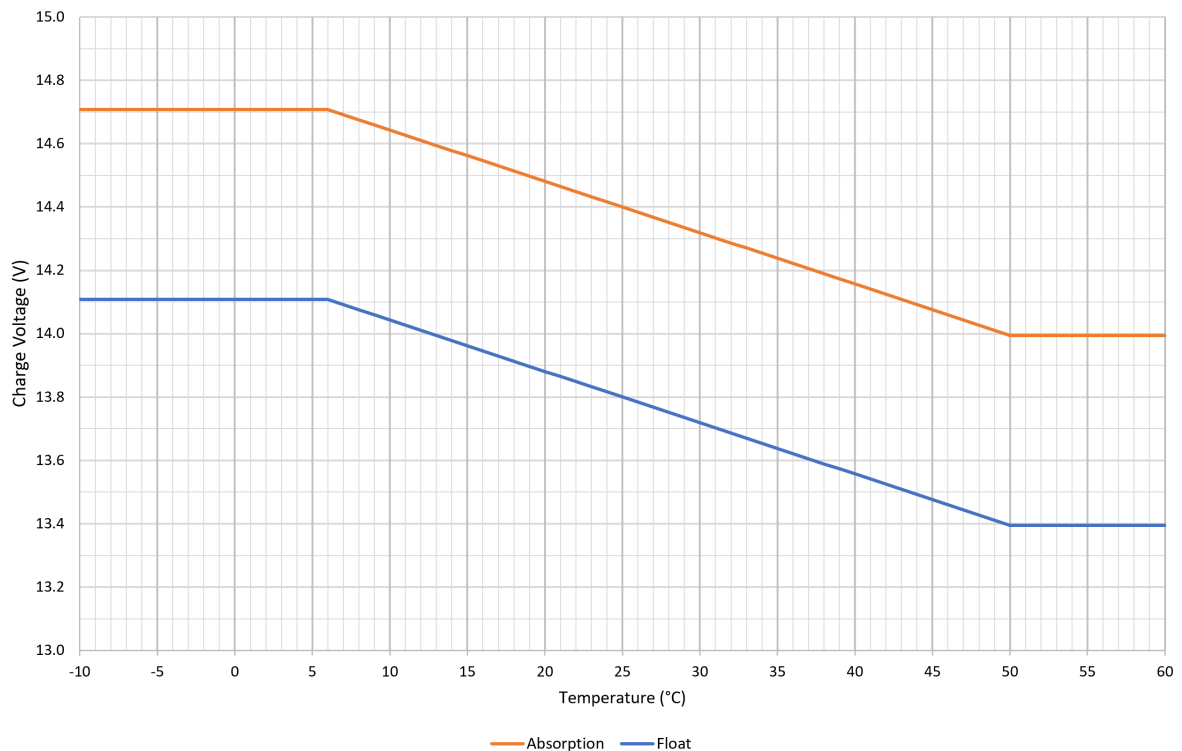

The temperature compensation coefficient is specified in mV/°C and applies to the entire battery/battery bank (not per battery cell).

If the battery manufacturer specifies a temperature compensation coefficient per cell, it will need to be multiplied by the total number of cells in series (there are typically 6 cells in series within a 12V lead-acid based battery).

4.4. VE.Smart Networking

The **Blue Smart IP22 Charger** range feature **VE.Smart Networking** capability, which enables Bluetooth connectivity and communication between multiple Victron products.

This powerful feature enables chargers to receive accurate battery voltage (Volt-sense), charge current (Current-sense) and battery temperature (Temp-sense) data from a compatible battery monitor (such as a BMV, SmartShunt, Smart Battery Sense or VE.Bus Smart Dongle) and/or multiple chargers to operate in unison with synchronised charging to further enhance the charge cycle.

A single compatible battery monitor (such as a BMV, SmartShunt, Smart Battery Sense or VE.Bus Smart Dongle) will provide voltage, temperature and/or current sense data to all (a single or multiple) chargers withing the common VE.Smart network.

Multiple compatible chargers in a common VE.Smart network (with or without a battery monitor) will also synchronise their charge algorithm (known as synchronised charging).



1. Only one battery monitor (BMV, SmartShunt, Smart Battery Sense or VE.Bus Smart Dongle) can be included in a VE.Smart network.
2. All battery monitor connections (voltage sensing cables, temperature sensor and current shunt) and chargers in a common VE.Smart network must be connected to the same battery / battery bank.
3. The maximum number of devices permitted in a VE.Smart network is 10.
4. Communication via VE.Smart networking requires all devices to be located within Bluetooth range of each other. Systems with poor or intermittent Bluetooth signal between devices will experience connection issues. Signal strength between devices can be checked in the VictronConnect VE.Smart networking page.
5. Multiple chargers in a common VE.Smart network must have the same charge settings, since the 'master' can change dynamically any charger could become the 'master'.
6. Multiple chargers in a common VE.Smart network do not need to be the same type or model, they just need to be VE.Smart Networking compatible (this includes VE.Smart Networking compatible Blue Smart chargers, Smart IP43 chargers and MPPT solar chargers).
7. Some older devices may not be VE.Smart networking compatible or have limitations; refer to the 'VE.Smart Networking Product Compatibility' table in the [VE.Smart Networking manual](#) to confirm.
8. Only **Blue Smart IP22 Chargers** with hardware revision 2 or later, introduced production week 24 of 2020, are VE.Smart networking compatible. Refer to the product label on the back of the charger to confirm the hardware revision ("hw rev 02" or later) and/or production date ("SN: HQ2024xxxx" or later).

4.4.1. Voltage sense

Voltage Sense uses battery voltage data that is accurately measured directly at the battery terminals (or very close) and provides it to the charger, the charger then uses this voltage data to dynamically increase the output voltage and precisely compensate for voltage drop in the cabling and connections between the charger and battery.

This enables the battery to be charged with the exact voltage as configured in the charger, instead of a lower voltage due to voltage drop in the cabling and connections.

Voltage drop is proportional to the charge current and cabling/connection resistance ($V=I \times R$), so voltage drop will vary during a charge cycle and can be quite significant when charging at higher charge currents through cabling and connections with higher than optimal resistance; in this scenario voltage sense will be particularly beneficial.

Note that voltage sense does **not** allow inadequately rated cabling/connections to be used or compensate for excessively high voltage drop; for reliable and safe operation cabling and connections must all be suitably rated and appropriately sized for the application; refer to the 'Installation > Wiring' section for more information.

4.4.2. Temperature sense

Temperature Sense uses battery temperature data that is accurately measured directly at a battery terminal or on the battery body and provides it to the charger, the charger then uses this temperature data to dynamically compensate the charge voltage (decrease or increase) according to the specified temperature coefficient ($X \text{ mV}/^{\circ}\text{C}$).

The optimal charge voltage of a lead acid based battery varies inversely with battery temperature with the nominal charge voltage specified at 25°C; automatic temperature-based charge voltage compensation avoids the need for manual charge voltage setting adjustments in hot or cold environments.

For lithium batteries the optimal charge voltage remains constant under all normal operating temperatures, however lithium batteries can be permanently damaged if charged in cold conditions; in this case the temperature sense data can be used to automatically disable charging in cold conditions (typically $<5^{\circ}\text{C}$).

4.4.3. Current sense

Current Sense uses battery current data that is measured by the battery monitor shunt (requires a BMV or SmartShunt) and provides it to the charger, the charger then references this current data (as opposed to the charger output current) for the tail current setting.

The tail current setting references the diminishing level of charge current (typical at the end of a full charge cycle) in relation to the trigger threshold to determine when the battery is fully charged and consequently when the absorption stage can be ended (prior to the absorption stage time limit being reached). The use of tail current to end absorption stage is a highly effective and common method used to properly charge lead acid based batteries.

In order to end the absorption phase at the correct point, it is important that the true current flow into the battery is referenced in relation to the tail current threshold, rather than the charger output current which may be significantly higher; if any loads are powered while charging a portion of the charger output current will be flowing directly to the loads, making the tail current condition more difficult or impossible to meet without current sense.

4.4.4. Synchronised charging

Synchronised charging capability enables multiple compatible chargers to be combined together in a common VE.Smart network, allowing the chargers to operate in unison as if they were one large charger.

The chargers will synchronise the charge algorithm between themselves with no further hardware or physical connections required, and simultaneously change charge states.

Synchronised charging works by systematically prioritising all chargers and assigning one as the 'master', this charger then controls the charge stage of all other 'slave' chargers. In case the initial 'master' is disconnected from the VE.Smart Network for any reason (out of Bluetooth range for example), another charger will be systematically reassigned as the 'master' and take over control; this can also be reversed if communication with the initial 'master' (that has a higher priority) is re-established. The 'master' charger can not be manually selected.

Synchronised charging does not regulate or equalise the current output of multiple chargers, each charger still has total control over it's own current output. Accordingly, current output variation between multiple chargers is normal (primarily dependent on cable resistance and charging conditions) and a total system current output limit cannot be configured.

Synchronised charging can be setup with different charger types, providing they are VE.Smart Networking compatible (this includes compatible Blue Smart IP22 chargers, Smart IP43 chargers and SmartSolar MPPT solar chargers). Charging from solar chargers is not prioritised over mains supply chargers, so in some installations (primarily dependent on cable resistance and charging conditions) it is possible for solar power to be underutilised.

Synchronised charging can also be used in conjunction with a battery monitor (BMV, SmartShunt, Smart Battery Sense or VE.Bus Smart Dongle) to provide voltage, temperature and/or current sense data to the chargers in a common VE.Smart network; refer to the 'Operation > VE.Smart Networking > Voltage sense / Temperature sense / Current sense' sections for more information.

In the absence of a battery monitor providing current-sense data (requires a BMV or SmartShunt), the charge current from each individual charger is combined by the 'master' and referenced against the tail current setting.

4.5. Commencing a new charge cycle

A new charge cycle will commence when:

1. The configured Re-bulk condition is satisfied (typically due to a large load):
 - a. 'Re-bulk method' set to 'Current' and 'Re-bulk current' is disabled (default configuration): The current output must be maintained at the maximum current output for four seconds.
 - b. 'Re-bulk method' is set to 'Current' and 'Re-bulk current' is configured with a user defined value: The current output must exceed the configured 'Re-bulk current' for four seconds while the charger is in float or storage stage.
 - c. 'Re-bulk method' is set to 'Voltage' and 'Re-bulk voltage offset' is configured with a user defined value: The battery voltage must drop below the configured 'Re-bulk voltage' for one minute.
 - d. The charger is in a VE.Smart network with synchronised charging: The battery voltage must drop below the configured 'Re-bulk voltage' for one minute (regardless of the 'Re-bulk method' selected).
2. The MODE button is pressed or used to select a new charge mode.
3. VictronConnect is used to select a new charge mode or change the function from 'Power Supply' to 'Charger' mode.
4. The power supply to the AC power supply has been isolated and reconnected.

4.6. Estimating charge time

The time required to recharge a battery to 100% SOC (state of charge) is dependant on the battery capacity, the depth of discharge, the charge current and the battery type/chemistry, which has a significant effect on the charge characteristics.

4.6.1. Lead-acid based chemistry

A lead-acid battery is normally at approximately 80% state of charge (SOC) when the bulk charge stage is completed.

The bulk stage duration T_{bulk} can be calculated as $T_{\text{bulk}} = Ah / I$, where I is the charge current (excluding any loads) and Ah is the depleted battery capacity below 80% SOC.

The absorption stage duration T_{abs} will vary depending on the depth of discharge; up to 8 hours of absorption may be required for a deeply discharged battery to reach 100% SOC.

For example, the time required to recharge a fully discharged Lead-acid based 100Ah battery with a 10A charger would be approximately:

- **Bulk stage** duration, $T_{\text{bulk}} = 100Ah \times 80\% / 10A = 8$ hours
- **Absorption stage** duration, $T_{\text{abs}} = 8$ hours
- **Total** charge duration, $T_{\text{total}} = T_{\text{bulk}} + T_{\text{abs}} = 8 + 8 = 16$ hours

4.6.2. Li-ion based chemistry

A Li-ion based battery is normally well above 95% state of charge (SOC) when the bulk charge stage is completed.

The bulk stage duration T_{bulk} can be calculated as $T_{\text{bulk}} = Ah / I$, where I is the charge current (excluding any loads) and Ah is the depleted battery capacity below 95% SOC.

The absorption stage duration T_{abs} required to reach 100% SOC is typically less than 30 minutes.

For example, the charge time of a fully discharged 100Ah battery when charged with a 10A charger to approximately 95% SOC is $T_{\text{bulk}} = 100 \times 95\% / 10 = 9.5$ hours.

For example, the time required to recharge a fully discharged Li-ion based 100Ah battery with a 10A charger would be approximately:

- **Bulk stage** duration, $T_{\text{bulk}} = 100Ah \times 95\% / 10A = 9.5$ hours
- **Absorption stage** duration, $T_{\text{abs}} = 0.5$ hours
- **Total** charge duration, $T_{\text{total}} = T_{\text{bulk}} + T_{\text{abs}} = 9.5 + 0.5 = 10$ hours

4.7. Multiple isolated outputs

The **Blue Smart IP22 Charger** 3 output models include an integrated FET battery isolator and multiple isolated outputs.

Multiple isolated outputs make it possible for a single charger to charge multiple individual batteries that are at a different voltage/SOC level without current flow between the batteries, and with the charge current intrinsically distributed between all batteries depending on their voltage/SOC level and capacity.

The 3 output charger models can supply the full rated output current from all 3 outputs; however the combined current of all outputs is limited to the full rated output current.



The multiple isolated outputs are not regulated individually, one charge algorithm (charge cycle and charge voltage) is applied to all outputs; accordingly all batteries will need to be compatible with the common charge algorithm (typically the same chemistry type).

5. Installation

5.1. Mounting

The **Blue Smart IP22 Charger** range is designed to be wall mounted using the flanges which protrude from either side of the base.

Before mounting, the following aspects should be considered to identify/provide a suitable and safe location:

- Install the charger in a location with good natural airflow/ventilation; in case airflow is a restricted, consider adding a cooling fan.
- Ensure there is sufficient unobstructed space around the charger; a minimum clearance of 100mm above and below is recommended.
- Install the charger on a non-flammable substrate and ensure there are no heat-sensitive items in the immediate vicinity; it is normal for the charger to become hot during operation.
- Install the charger in a location where it is protected from environmental conditions such as water, high moisture and dust, and also located well away from any flammable liquids or gasses.
- Do not install or place/operate the charger on top of the battery, directly above the battery, or in a sealed compartment with the battery; batteries can emit explosive gasses.
- Do not cover or place any other items on top of the charger.

Mount the **Blue Smart IP22 Charger** vertically with terminals facing down; secure using the 4 mounting holes/slots on the base.

Use well fitting pan/flange head screws to secure the unit, ensure that the screw thread outer diameter is a clearance fit within the flange holes/slots (~4mm max OD).

To aid installation, it is recommended to 'support' the unit using the 2 lower screws (leave the screw heads ~3mm from the surface) and then install the 2 upper screws, before fully securing all 4 screws.

Take care to not over-tighten the mounting screws (as the mounting flanges are plastic), and to not damage the AC power cable while securing the lower left mounting screw (as the AC power cable is located directly above it).

Refer to the drawing below for mounting dimensions:

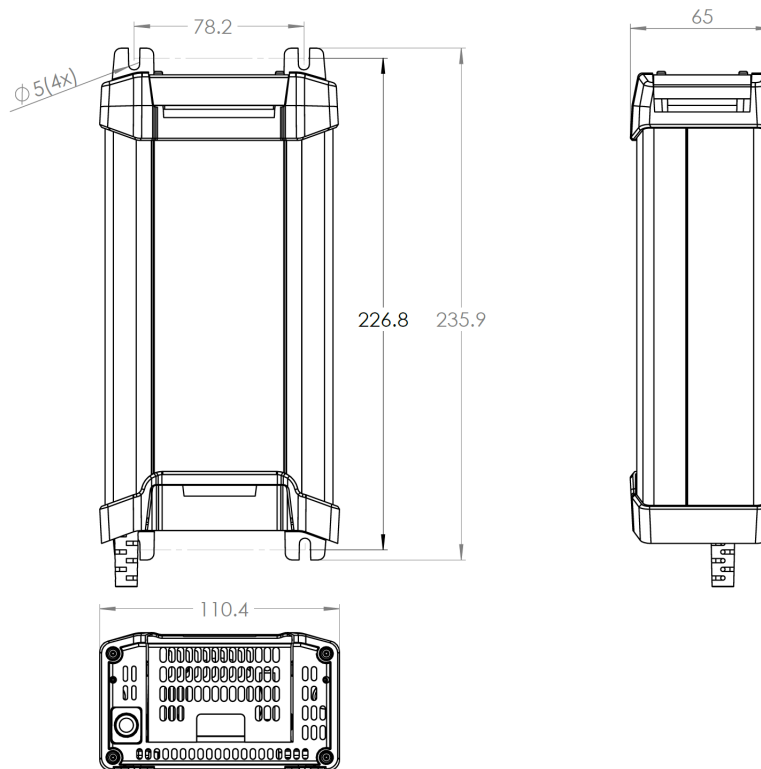

5.2. Wiring

Connect DC power cabling between the **Blue Smart IP22 Chargers** BATTERY terminals (located under the lower connection cover) and the battery/batteries or DC system distribution bus.

- Ensure that the DC system is fully shut down (all DC loads and charge sources off/isolated) prior to disconnection of any existing battery/DC system distribution bus cabling and connection of the charger to the battery terminals/DC system distribution bus.
- Use flexible multi stranded copper DC power cable with sufficient cross sectional area, inline with an appropriate fuse or circuit breaker; refer to the 'Installation > Wiring > DC power cable' and 'Installation > Wiring > Overcurrent protection' sections for more information.
- Ensure that wiring polarity is correct; use red cabling for the + (positive) connections and black cabling for the - (negative) connections.
- Torque the terminal screws to 2.4Nm using a small torque wrench with a suitable screw driver bit, and reinstall the lower connection cover.

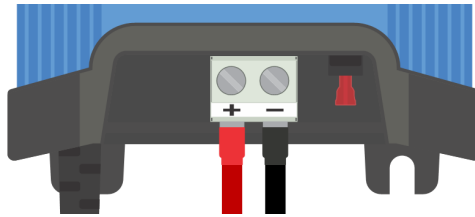

Connect the AC power cable to a mains power outlet; after a short delay, the LEDs indicating the current charge mode and charge state will illuminate.

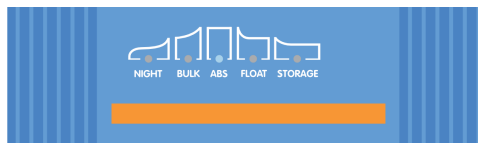

Example wiring schematics for most typical installation configurations have been provided - refer to the 'Installation > Schematics' section for more information.

5.2.1. DC Power cable

To ensure reliable and safe operation it is important to select and install suitably rated DC power cabling between the **Blue Smart IP22 Charger** and the battery/batteries.

Cable type/specification selection should consider the following aspects:

a. Conductor material and cross sectional area

Conductor material and cross sectional area effects the resistance of a cable per unit length, and accordingly determines the maximum current capability/rating, as well as the power loss / voltage drop over the total cable length.

- To prevent overheating of the cable and/or interfacing equipment, select high quality power cable with copper conductors and a conductor cross sectional area appropriately sized for the application.

The cable manufacturers maximum current rating for the cable (after applying any de-rating factors applicable to the installation) must exceed the maximum operating current possible within the system, and the cable must also be capable to safely withstand the fault current required to blow the fuse / trip the circuit breaker.

- To prevent high power loss and operational issues due to excessive voltage drop, design the system layout so that cable lengths are as short as possible and if needed increase conductor cross sectional area to reduce voltage drop to an acceptable level.

If needed, it is recommended to increase conductor cross sectional area so that the voltage drop over the total cable length is below ~0.5V and ~3% at maximum operating current.

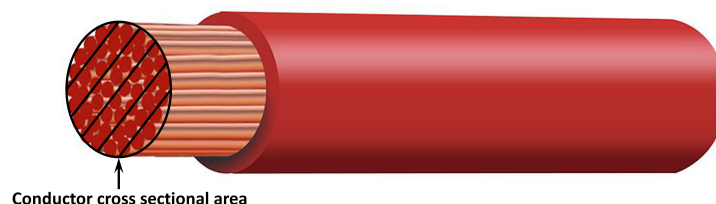

b. Strand diameter

Strand diameter effects the contact area / resistance and accordingly determines the amount heat generated at terminations, as well as the flexibility capability/rating of the cable.

- i. To prevent overheating of the cable and/or interfacing equipment at/near terminations, select high quality power cable with fine multi-stranded copper conductors.

In order to maximise contact area and minimise resistance at terminations, the diameter of each individual copper strand must not exceed 0.4mm (0.016 inch) or a surface area of 0.125mm² (AWG26).

If cable with a thicker strand diameter is used, the contact area at the interface between the conductor strands and termination will be insufficient and cause excessive resistance. A high resistance electrical connection will generate substantial heat when operating under load and result in severe overheating or potentially a fire.

- ii. To enable easy cable routing with tight bends and prevent failure of the cable and/or interfacing equipment due to excessive force/stress at terminations and/or cyclic fatigue, select high quality power cable specifically designed for applications requiring high flexibility.

It is recommended to use high quality power cable with a flexibility class rating of 5 or higher (according to VDE 0295, IEC 60228 and BS6360).

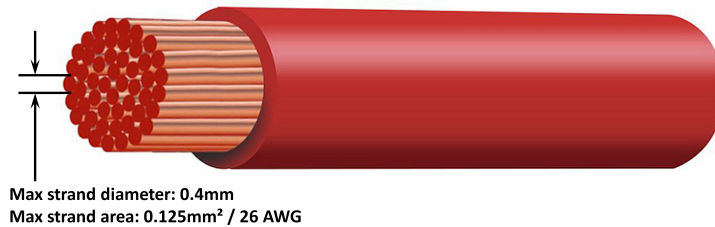

c. Insulation type

Insulation type effects the maximum temperature capability/rating and accordingly the maximum current capability/rating, as well as the maximum voltage isolation capability/rating of a cable.

- i. To prevent overheating of the cable insulation, select high quality power cable with an insulation temperature rating appropriate for the installation.

The cable manufacturers insulation temperature rating must exceed the maximum projected temperature for the installation, when considering the combination of maximum possible surrounding temperature and temperature rise due the heat generated by the cable itself under maximum load.

It is recommended to use high quality power cable with a maximum temperature rating of at least 90°C (194°F).

- ii. To ensure robust electrical isolation, select high quality power cable with an insulation voltage rating appropriate for the maximum operating voltage of the system.

It is recommended to use high quality power cable with a maximum voltage rating of 0.6/1kV.

Refer to the table below for the recommended minimum cable cross sectional area / gauge in relation to cable length (one way length between charger and battery):

Charger model	Max output current	Minimum conductor cross sectional area			
		<2.5m	2.5 to 5.0m	5.0 to 7.5m	7.5 to 10m
12/15	15A	4mm ² 12 AWG	10mm ² 8 AWG	10mm ² 8 AWG	16mm ² 6 AWG
12/20	20A	6mm ² 10 AWG	10mm ² 8 AWG	16mm ² 6 AWG	16mm ² 6 AWG
12/30	30A	10mm ² 8 AWG	16mm ² 6 AWG	16mm ² 6 AWG	NR
24/8	8A	4mm ² 12 AWG	4mm ² 12 AWG	6mm ² 10 AWG	10mm ² 8 AWG
24/12	12A	4mm ² 12 AWG	6mm ² 10 AWG	10mm ² 8 AWG	10mm ² 8 AWG
24/16	16A	4mm ² 12 AWG	10mm ² 8 AWG	10mm ² 8 AWG	16mm ² 6 AWG

i Certain combinations with high current and very long cable length are not recommended (NR) as voltage drop will be excessive even with the largest compatible cable size; in addition to high power loss this may cause charging issues.

5.2.2. Overcurrent protection

To ensure reliable and safe operation it is important to select and install a suitably rated inline fuse or circuit breaker as close as practical to the battery/batteries, inline with the DC power cabling between the **Blue Smart IP22 Charger** and battery/batteries.

The primary purpose of an inline fuse or circuit breaker located close to the battery/batteries is to protect the cabling and system in the event of an overcurrent fault, such as a short circuit in the wiring.

In the event of a short circuit in the wiring between the battery/batteries and **Blue Smart IP22 Charger**, the battery/batteries have the capability to provide extremely high current flow through the cabling, which can result in severe overheating or potentially a fire unless the circuit is broken immediately by a suitable fuse or circuit breaker.

Refer to the table below for the recommended fuse / circuit breaker rating:

Charger model	Max output current	Fuse / circuit breaker rating	
		Minimum	Maximum
12/15	15A	20A	25A
12/20	20A	25A	30A
12/30	30A	40A	50A
24/8	8A	10A	15A
24/12	12A	15A	20A
24/16	16A	20A	25A

5.3. Schematics

5.3.1. Basic installation

Single battery

Refer to the wiring schematic below to connect the **Blue Smart IP22 Charger** (1 output model) to a single battery / battery bank:

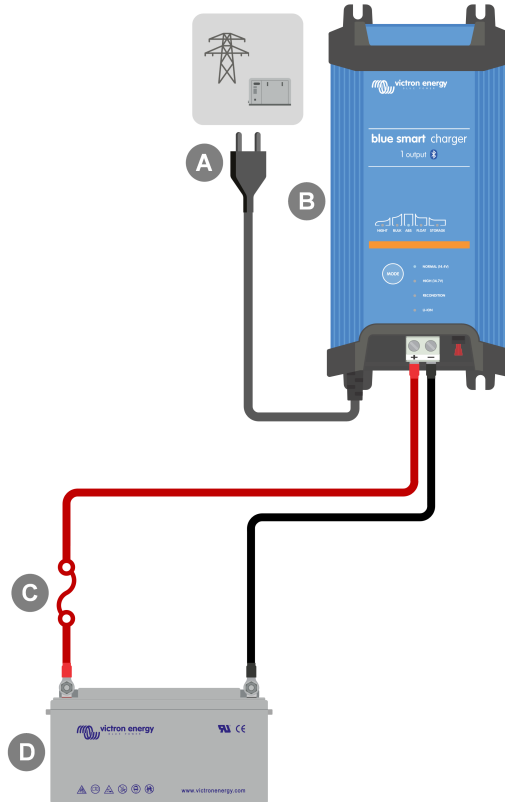

Key	Description
A	AC power supply (mains power grid, generator or inverter)
B	Blue Smart IP22 Charger (1 output model)
C	Fuse / circuit breaker (locate as close as practical to battery)
D	Battery / battery bank

Multiple batteries

Refer to the wiring schematic below to connect the **Blue Smart IP22 Charger** (3 output model) to multiple independent batteries / battery banks:

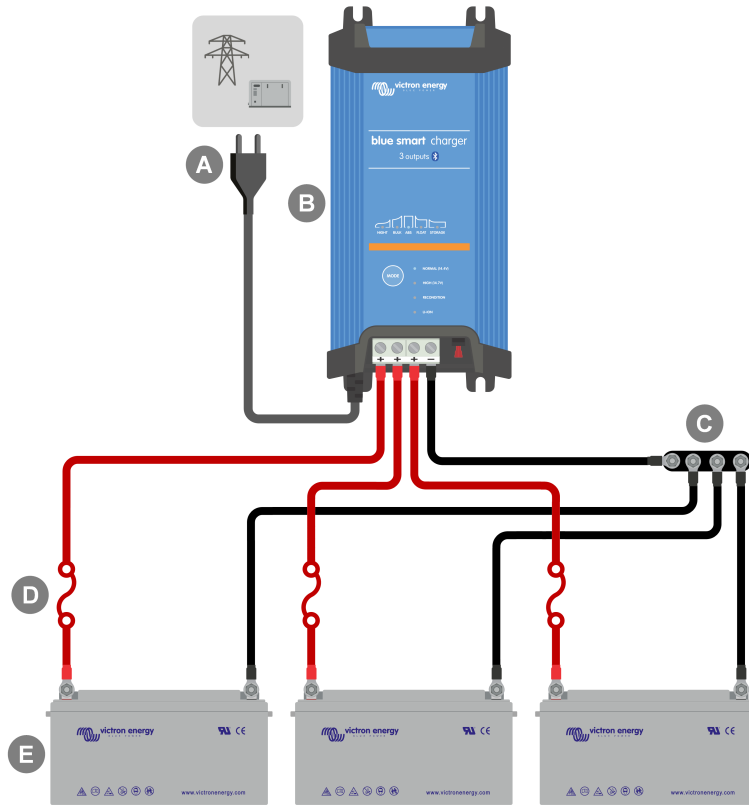

Key	Description
A	AC power supply (mains power grid, generator or inverter)
B	Blue Smart IP22 Charger (3 output model)
C	DC negative busbar
D	Fuses / circuit breakers x3 (locate as close as practical to batteries)
E	Batteries / battery banks x3 (any combination of 1, 2 or 3 batteries)

5.3.2. VE.Smart Networking

Single battery with Smart Battery Sense

Refer to the wiring schematic below to connect the **Blue Smart IP22 Charger** (1 output model) to a single battery / battery bank with a Smart Battery Sense:

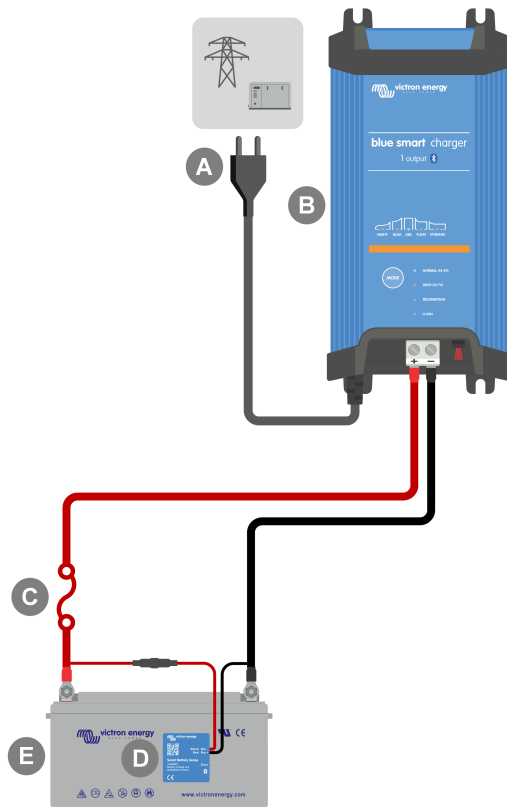

Key	Description
A	AC power supply (mains power grid, generator or inverter)
B	Blue Smart IP22 Charger (1 output model)
C	Fuse / circuit breaker (locate as close as practical to battery)
D	Smart Battery Sense
E	Battery / battery bank

i A **VE.Smart Network** must be setup between the **Blue Smart IP22 Charger** and Smart Battery Sense to enable Bluetooth connectivity and communication between devices; refer to the 'Advanced Configuration > VE.Smart Networking' section for more information.

Multiple batteries with Smart Battery Sense

Refer to the wiring schematic below to connect the **Blue Smart IP22 Charger** (3 output model) to multiple independent batteries / battery banks with a Smart Battery Sense:

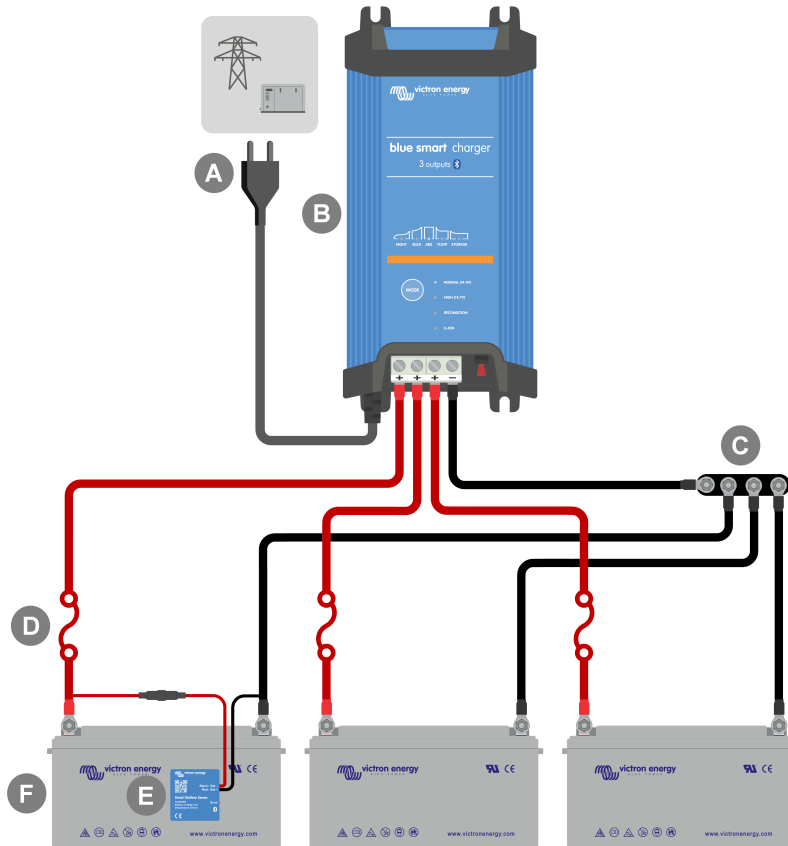

Key	Description
A	AC power supply (mains power grid, generator or inverter)
B	Blue Smart IP22 Charger (3 output model)
C	DC negative busbar
D	Fuses / circuit breakers x3 (locate as close as practical to batteries)
E	Smart Battery Sense
F	Batteries / battery banks x3 (any combination of 1, 2 or 3 batteries)

i A **VE.Smart Network** must be setup between the **Blue Smart IP22 Charger** and Smart Battery Sense to enable Bluetooth connectivity and communication between devices; refer to the 'Advanced Configuration > VE.Smart Networking' section for more information.

Single battery with SmartShunt

Refer to the wiring schematic below to connect the **Blue Smart IP22 Charger** (1 output model) to a single battery / battery bank with a SmartShunt or BMV battery monitor:

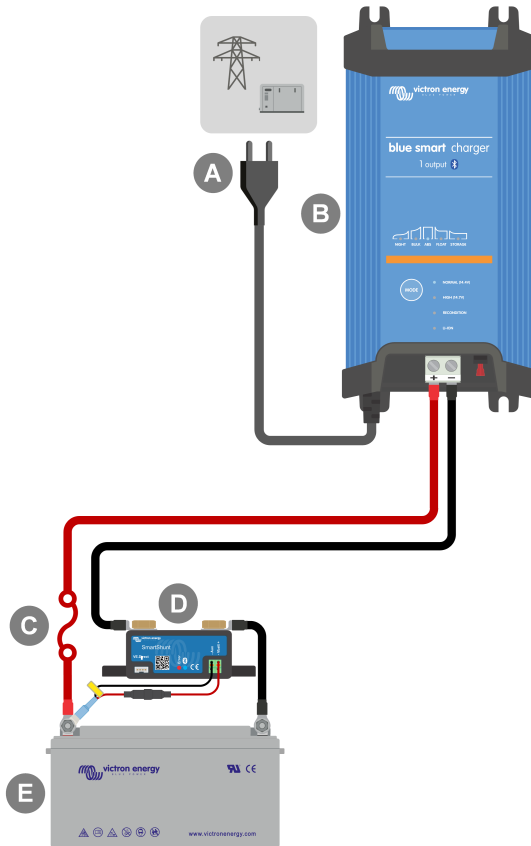

Key	Description
A	AC power supply (mains power grid, generator or inverter)
B	Blue Smart IP22 Charger (1 output model)
C	Fuse / circuit breaker (locate as close as practical to battery)
D	SmartShunt or BMV battery monitor shunt (locate as close as practical to battery, shown with optional temperature sensor PN: ASS000100000)
E	Battery / battery bank

i A **VE.Smart Network** must be setup between the **Blue Smart IP22 Charger** and SmartShunt or BMV battery monitor to enable Bluetooth connectivity and communication between devices; refer to the 'Advanced Configuration > VE.Smart Networking' section for more information.

Multiple batteries with SmartShunt

Refer to the wiring schematic below to connect the **Blue Smart IP22 Charger** (3 output model) to multiple independent batteries / battery banks with a SmartShunt or BMV battery monitor:

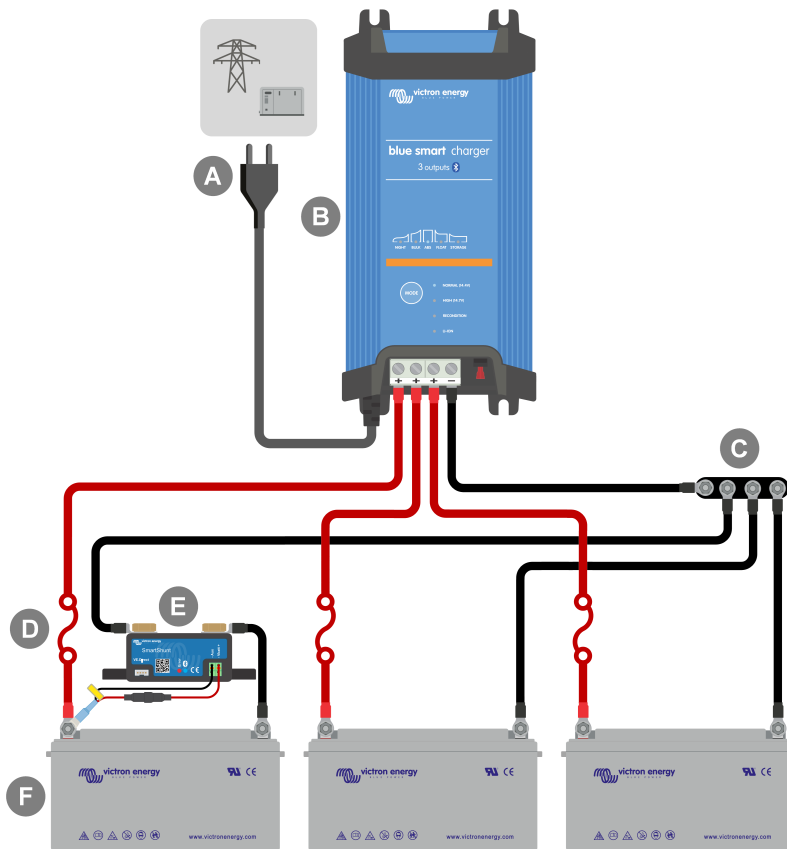

Key	Description
A	AC power supply (mains power grid, generator or inverter)
B	Blue Smart IP22 Charger (3 output model)
C	DC negative busbar
D	Fuses / circuit breakers x3 (locate as close as practical to batteries)
E	SmartShunt or BMV battery monitor shunt (locate as close as practical to battery, shown with optional temperature sensor PN: ASS000100000)
F	Batteries / battery banks x3 (any combination of 1, 2 or 3 batteries)

i A **VE.Smart Network** must be setup between the **Blue Smart IP22 Charger** and SmartShunt or BMV battery monitor to enable Bluetooth connectivity and communication between devices; refer to the 'Advanced Configuration > VE.Smart Networking' section for more information.

5.3.3. Multiple chargers

Multiple chargers in parallel (with optional SmartShunt)

Refer to the wiring schematic below to connect multiple **Blue Smart IP22 Chargers** in parallel to a battery / battery bank (with an optional SmartShunt or BMV battery monitor):

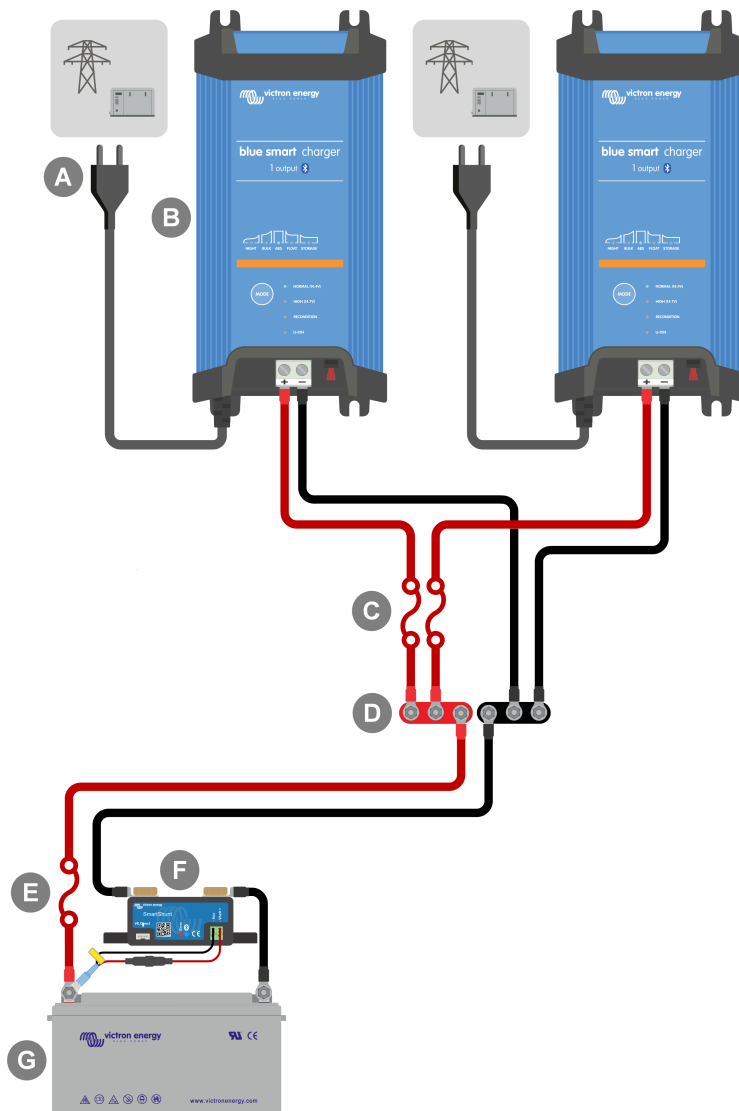

Key	Description
A	AC power supply x2 (mains power grid, generator or inverter)
B	Blue Smart IP22 Chargers x2
C	Fuses / circuit breakers x2 (locate as close as practical to DC positive bus bar)
D	DC positive and negative busbar
E	Fuse / circuit breaker (locate as close as practical to battery)
F	SmartShunt or BMV battery monitor shunt (SmartShunt/BMV is optional, locate as close as practical to battery, shown with optional temperature sensor PN: ASS000100000)
G	Battery / battery bank

i A **VE.Smart Network** must be setup between all **Blue Smart IP22 Chargers** connected in parallel (and the optional SmartShunt or BMV battery monitor, if used) to enable Bluetooth connectivity and communication between devices; refer to the 'Advanced Configuration > VE.Smart Networking' section for more information.

6. Setup

6.1. Setup using the charger

The charge mode and charge current limit most appropriate for the battery type and capacity can be selected directly on the charger, using the MODE button.

1. Connect the AC power cable to a mains power outlet; after a short delay, the LEDs indicating the current charge mode and charge state will illuminate.

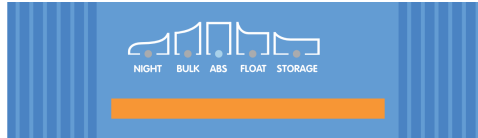

2. Select the most appropriate mode from the integrated charge presets (Normal, Normal + Recondition, High, High + Recondition or Li-ion) by briefly pressing the MODE button on the charger to cycle through each option; the LED beside the currently selected charge mode (NORMAL / HIGH / LI-ION) will be illuminated, as well as the RECONDITION LED if recondition stage is enabled.

Ensure that recondition stage is only enabled when required, as unnecessary or overuse will reduce battery life.

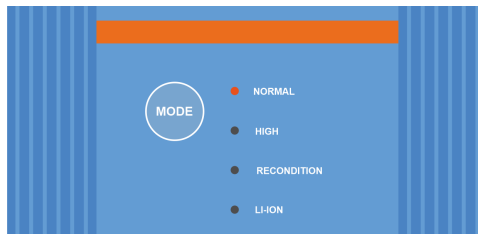

3. If required, enable low current mode (charge current limited to 50% of the maximum rated charge current and disabled fan); to enable (or disable) low current mode depress and hold the MODE button for 6 seconds, when enabled the NIGHT LED will blink.

Alternatively night mode can be enabled, which temporarily activates low current mode for a period of 8 hours (typically overnight to eliminate fan noise); to enable (or disable) night mode depress and hold the MODE button for 3 seconds, when enabled the NIGHT LED will be illuminated.

The charger will automatically store the selected charge mode and recall it for future charge cycles (even after being disconnected from power).



To ensure proper charging, battery longevity and safe operation it is important to select a charge mode appropriate for the battery type and capacity being charged; refer to the 'Operation > Charge modes' section and the battery manufacturer's recommendations for more information.

6.2. Setup using Bluetooth

The charge mode and charge current limit most appropriate for the battery type and capacity can also be selected using Bluetooth enabled device (such as a mobile phone or tablet) with the VictronConnect app.

For further details about the VictronConnect app refer to the [VictronConnect manual](#).

1. Download and install the VictronConnect app onto the mobile phone or tablet.
The VictronConnect app can be downloaded from the following locations:
 - i. Android - Google Play Store
 - ii. iOS/Mac - Apple App Store
 - iii. Windows and other - [Victron Energy website > Downloads > Software](#)
2. Enable Bluetooth on the Bluetooth enabled device (mobile phone or tablet) if not already enabled, but do not attempt to pair with the **Blue Smart IP22 Charger**.
3. Connect the AC power cable to a mains power outlet; after a short delay, the LEDs indicating the current charge mode and charge state will illuminate.



4. Open the VictronConnect app and locate the **Blue Smart IP22 Charger** in the 'LOCAL' page device list, under 'Other devices'.

In case the **Blue Smart IP22 Charger** doesn't automatically appear, ensure that the mobile phone or tablet has Bluetooth enabled and is within close range, then perform a manual scan for devices by selecting the 'scan' button (round orange button with circular arrow) in the bottom right corner.

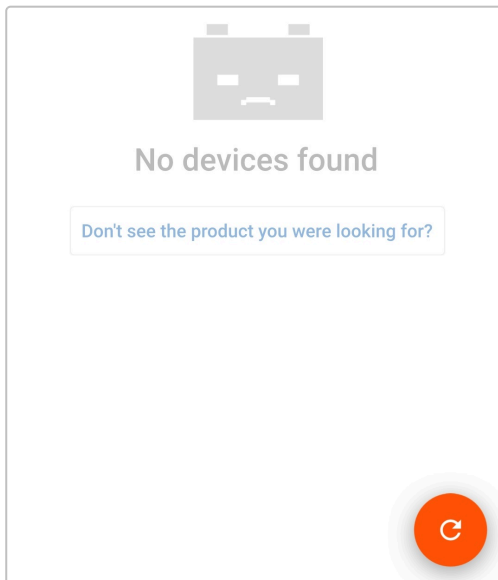

5. Select the **Blue Smart IP22 Charger** from the 'LOCAL' page device list, under 'Other devices'.

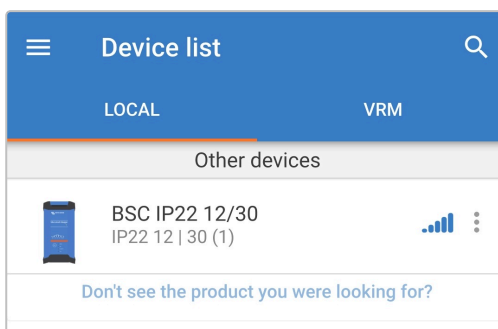

6. During initial connection a 'Bluetooth pairing request' prompt will appear requesting the Bluetooth PIN code; enter the default PIN code 000000, then select 'Pair'.

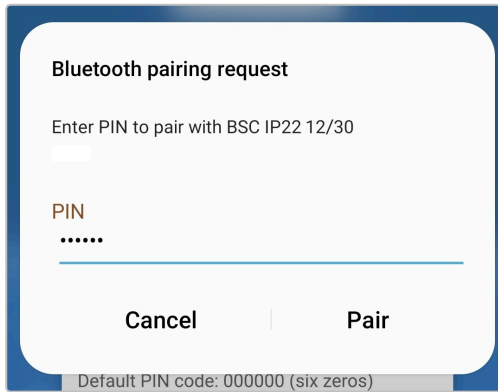

7. Select the 'Setting' icon (gear in the top right corner) to access the 'Settings' page.

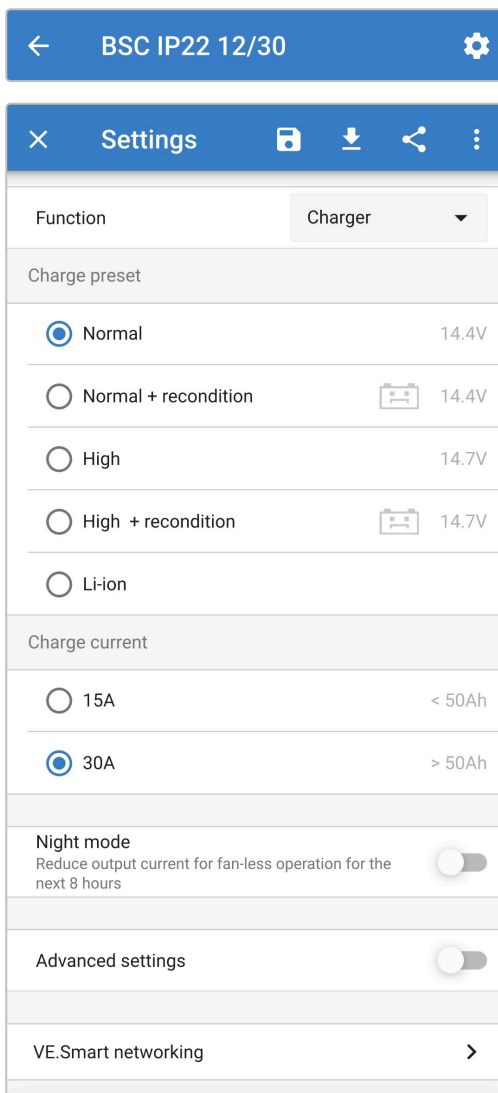

- Select the most appropriate mode from the integrated charge presets (Normal, Normal + Recondition, High, High + Recondition or Li-ion) in the 'Charge preset' menu; the LED beside the currently selected charge mode (NORMAL / HIGH / LI-ION) will be illuminated, as well as the RECONDITION LED if enabled.

Ensure that recondition stage is only enabled when required, as unnecessary or overuse will reduce battery life.

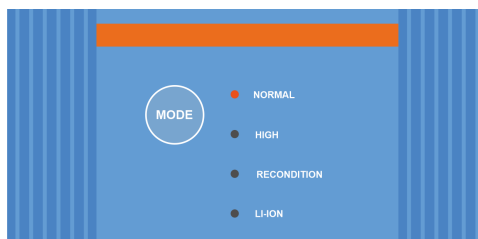
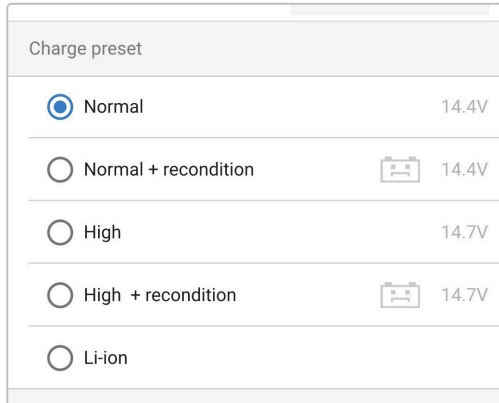

- If required, enable low current mode (charge current limited to 50% of the maximum rated charge current and disabled fan); to enable (or disable) low current mode select the required option from the 'Charge current' menu, when enabled the NIGHT LED will blink.

Alternatively night mode can be enabled, which temporarily activates low current mode for a period of 8 hours (typically overnight to eliminate fan noise); to enable (or disable) night mode toggle the 'Night mode' switch on (or off to disable), when enabled the NIGHT LED will illuminate.

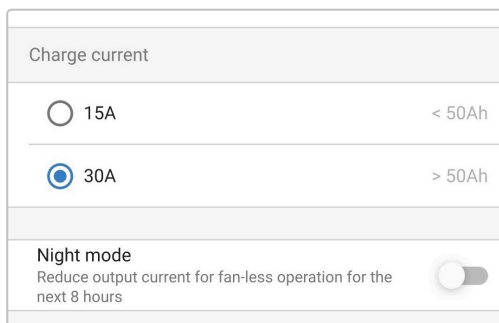

The charger will automatically store the selected charge mode and recall it for future charge cycles (even after being disconnected from power).

i To ensure proper charging, battery longevity and safe operation it is important to select a charge mode appropriate for the battery type and capacity being charged; refer to the 'Operation > Charge modes' section and the battery manufacturer's recommendations for more information.

6.3. Bluetooth

6.3.1. Changing the PIN code

To prevent an unauthorised Bluetooth connection, it is highly recommended to change the default PIN code.

The Bluetooth PIN code can be changed using a Bluetooth enabled device (such as a mobile phone or tablet) with the VictronConnect app.

To change the Bluetooth PIN code:

1. Connect the AC power cable to a mains power outlet; after a short delay, the LEDs indicating the current charge mode and charge state will illuminate.
2. Using a Bluetooth enabled device (such as a mobile phone or tablet), open the **VictronConnect** app and locate the **Blue Smart IP22 Charger** in the 'LOCAL' page device list, then connect to the device (default Bluetooth PIN code is 000000).
3. Select the 'Setting' icon (gear in the top right corner) to access the 'Settings' page.



4. Select the 'device options' icon (three vertical dots in the top right corner) to access the 'device options' menu.



5. Select 'Product info' to access the 'Product info' page.

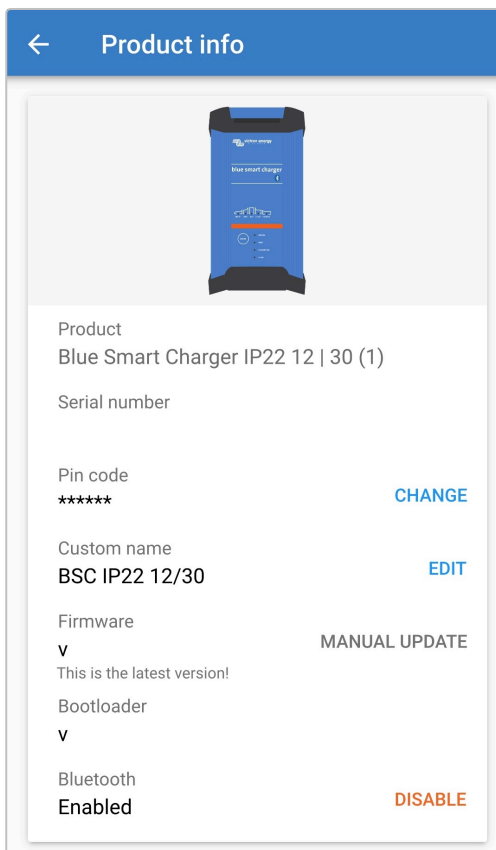
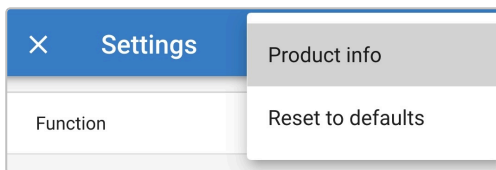

6. Select 'CHANGE' (beside 'Pin code') to open the 'Change PIN code' window.



7. Enter the current PIN code and the desired new PIN code (twice), then select 'OK'; avoid using an obvious PIN code that is easy for someone else to guess, such as 123456.

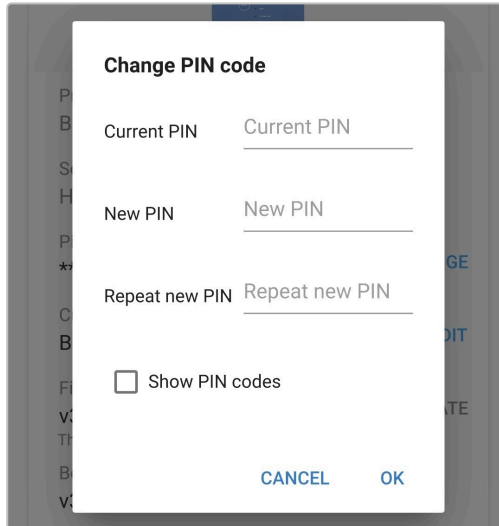

6.3.2. Resetting the PIN code

If the PIN code is forgotten or lost, it can be reset to the default 000000 using the MODE button on the charger or a Bluetooth enabled device (such as a mobile phone or tablet) with the VictronConnect app.

Reset PIN using the charger

To reset the Bluetooth PIN code:

1. Connect the AC power cable to a mains power outlet; after a short delay, the LEDs indicating the current charge mode and charge state will illuminate.
2. Depress and hold the MODE button on the **Blue Smart IP22 Charger** for 10 seconds.
3. All charge mode LEDs will blink twice to indicate that the PIN code has been successfully reset.



During this procedure:

- a. The PIN code is reset to default (000000)
- b. The active Bluetooth connection is disconnected
- c. All Bluetooth pairing information is cleared

Accordingly, it's also necessary to remove/clear the Blue Smart IP22 Charger Bluetooth pairing information from any Bluetooth enabled devices (mobile phones or tablets) that were previously paired before attempting to re-connect.

Reset PIN using Bluetooth

To reset the Bluetooth PIN code:

1. Locate and record the PUK code for reference later; the PUK code is located on a label stuck to the back of the **Blue Smart IP22 Charger**.
2. Connect the AC power cable to a mains power outlet; after a short delay, the LEDs indicating the current charge mode and charge state will illuminate.
3. Using a Bluetooth enabled device (such as a mobile phone or tablet), open the **VictronConnect** app and locate the **Blue Smart IP22 Charger** in the 'LOCAL' page device list.
4. Select the 'device options' icon (three vertical dots on the right side of the description) to access the Bluetooth pairing 'device options' menu.

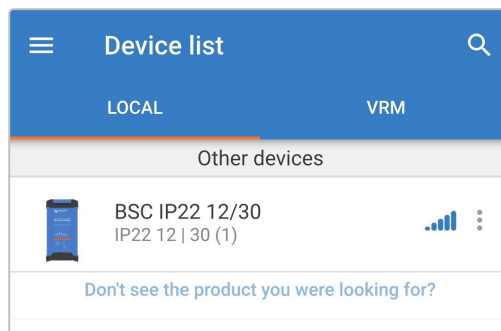

5. Select 'Reset PIN code' to open the 'Reset PIN code' window.

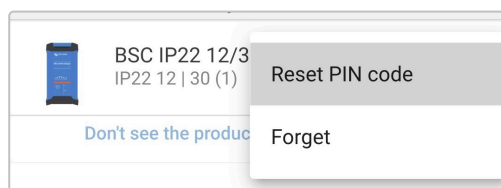

6. Enter the PUK code (recorded earlier) and select 'OK'.

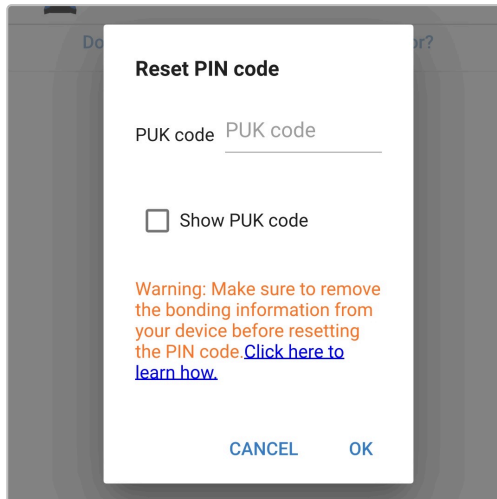

7. All charge mode LEDs will blink twice to indicate that the PIN code has been successfully reset.

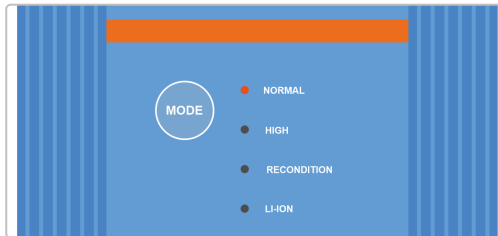

During this procedure:

- a. The PIN code is reset to default (000000)
- b. Bluetooth pairing information is **not** cleared

Accordingly, it's **not** necessary to remove/clear the Blue Smart IP22 Charger Bluetooth pairing information from any Bluetooth enabled devices (mobile phones or tablets) that were previously paired before attempting to re-connect.

6.3.3. Disabling Bluetooth

It is possible to totally disable Bluetooth communication if desired, using a Bluetooth enabled device (such as a mobile phone or tablet) with the VictronConnect app.

Typically, there is no need to disable Bluetooth since unauthorised access is protected with a PIN code, but certain situations may warrant it for an even higher level of security.

To disable Bluetooth:

1. Connect the AC power cable to a mains power outlet; after a short delay, the LEDs indicating the current charge mode and charge state will illuminate.
2. Using a Bluetooth enabled device (such as a mobile phone or tablet), open the **VictronConnect** app and locate the **Blue Smart IP22 Charger** in the 'LOCAL' page device list, then connect to the device (default Bluetooth PIN code is 000000).
3. Select the 'Setting' icon (gear in the top right corner) to access the 'Settings' page.



4. Select the 'device options' icon (three vertical dots in the top right corner) to access the 'device options' menu.



5. Select 'Product info' to access the 'Product info' page.

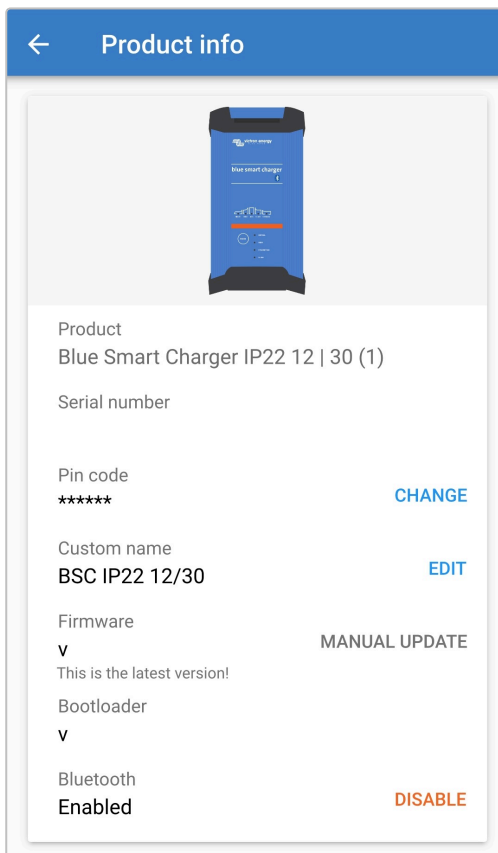
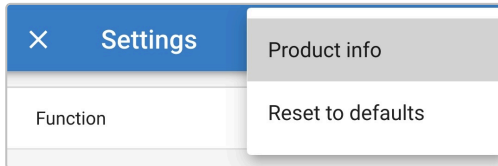

6. Select 'DISABLE' (beside 'Bluetooth Enabled') to open the 'Disable Bluetooth' window.

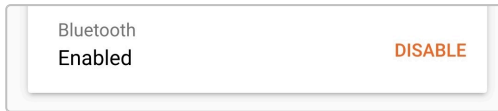

7. Read the warning message, then tick the checkbox and select 'OK' to accept and progress.

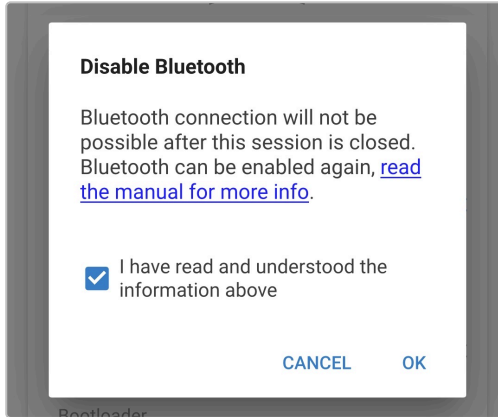

8. Bluetooth will now be disabled, but can be re-enabled again.

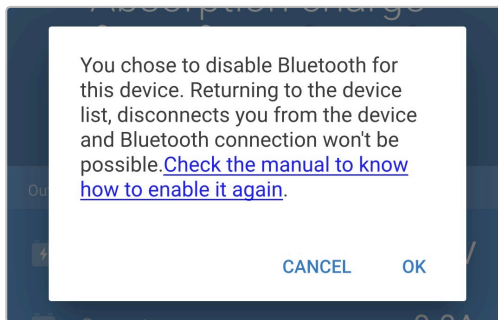

6.3.4. Re-enabling Bluetooth

It is possible to re-enable Bluetooth communication using the MODE button on the charger.

To re-enable Bluetooth:

1. Connect the AC power cable to a mains power outlet; after a short delay, the LEDs indicating the current charge mode and charge state will illuminate.
2. Depress and hold the MODE button on the **Blue Smart IP22 Charger** for 10 seconds.
3. All charge mode LEDs will blink twice to indicate that Bluetooth has been successfully re-enabled, and all Bluetooth settings reset.

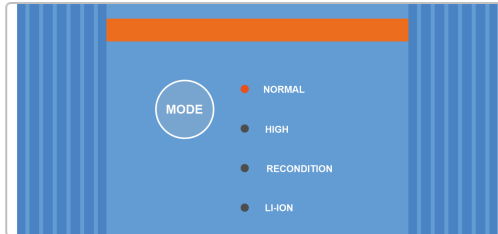

During this procedure:

- a. Bluetooth is re-enabled
- b. The PIN code is reset to default (000000)
- c. All Bluetooth pairing information is cleared

Accordingly, it's also necessary to remove/clear the Blue Smart IP22 Charger Bluetooth pairing information from any Bluetooth enabled devices (mobile phones or tablets) that were previously paired before attempting to re-connect.

6.4. Reset to defaults

If needed, it is possible to reset/restore all **Blue Smart IP22 Charger** settings to factory defaults.

Note that this does **not** reset any Bluetooth related settings, such as the PIN code or pairing information.

Settings can be reset/restored to factory defaults using a Bluetooth enabled device (such as a mobile phone or tablet) with the **VictronConnect** app.

To perform a system reset:

1. Connect the AC power cable to a mains power outlet; after a short delay, the LEDs indicating the current charge mode and charge state will illuminate.
2. Using a Bluetooth enabled device (such as a mobile phone or tablet), open the **VictronConnect** app and locate the **Blue Smart IP22 Charger** in the 'LOCAL' page device list, then connect to the device (default Bluetooth PIN code is 000000).
3. Select the 'Setting' icon (gear in the top right corner) to access the 'Settings' page.



4. Select the 'device options' icon (three vertical dots in the top right corner) to access the 'device options' menu.



5. Select 'Reset to defaults' to open the 'Restore device?' window.

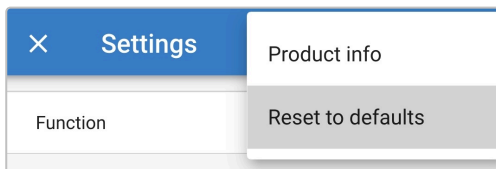

6. Select 'YES' to reset/restore all settings to factory defaults.

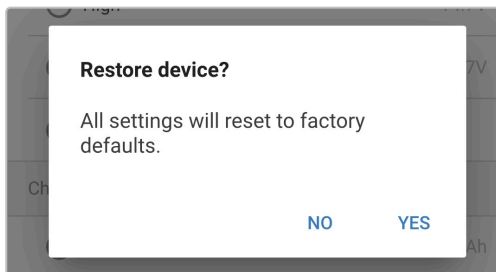

7. Monitoring

7.1. LED indications

7.1.1. Operation states

The **Blue Smart IP22 Charger** has multiple LEDs that can be referenced to determine the current charge state and other operational information.

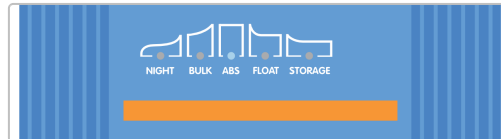

Refer to the LED indications in the table below:

Operation state	NIGHT	BULK	ABS	FLOAT	STORAGE
Bulk	N/A	Illuminated	Off	Off	Off
Absorption	N/A	Off	Illuminated	Off	Off
Recondition *1	N/A	Off	Illuminated	Off	Off
Float	N/A	Off	Off	Illuminated	Off
Storage	N/A	Off	Off	Off	Illuminated
Power supply mode	N/A	Illuminated	Illuminated	Illuminated	Illuminated
Low current mode	Blinking	N/A	N/A	N/A	N/A
Night mode	Illuminated	N/A	N/A	N/A	N/A
Error *2	N/A	Blinking	Blinking	Blinking	Blinking
VE.Smart networking	N/A	Active charge state LED will blink (turn off) momentarily every 4s			



*1 The RECONDITION LED will also blink during recondition stage.

*2 Use a Bluetooth enabled device (such as a mobile phone or tablet) with the VictronConnect app to determine the specific error code.

7.2. VictronConnect

The charger operation and recharge statistics can be closely monitored live or post charging using a Bluetooth enabled device (such as a mobile phone or tablet) with the VictronConnect app.

There are 3 different overview screens available (STATUS, GRAPH and HISTORY), each displaying different monitoring or historical data; spanning back over the last 40 charge cycles.

The desired screen can be selected by either selecting the window title or by swiping across between screens.

7.2.1. Status screen

The STATUS screen is the main overview screen; it displays the function mode (charger or power supply), the active charge state (in charger mode), the battery voltage and the charge/output current.

This data will update continuously in real time as the charge cycle progresses.

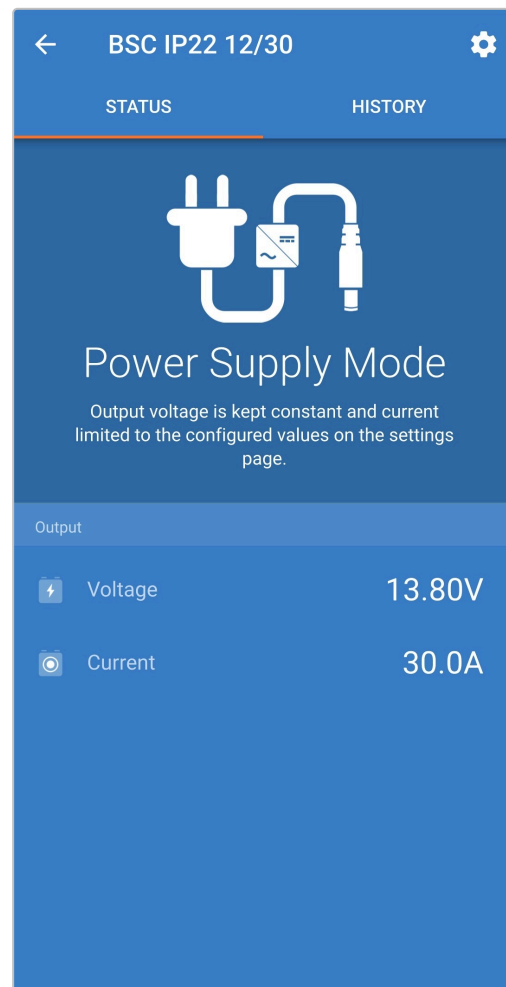
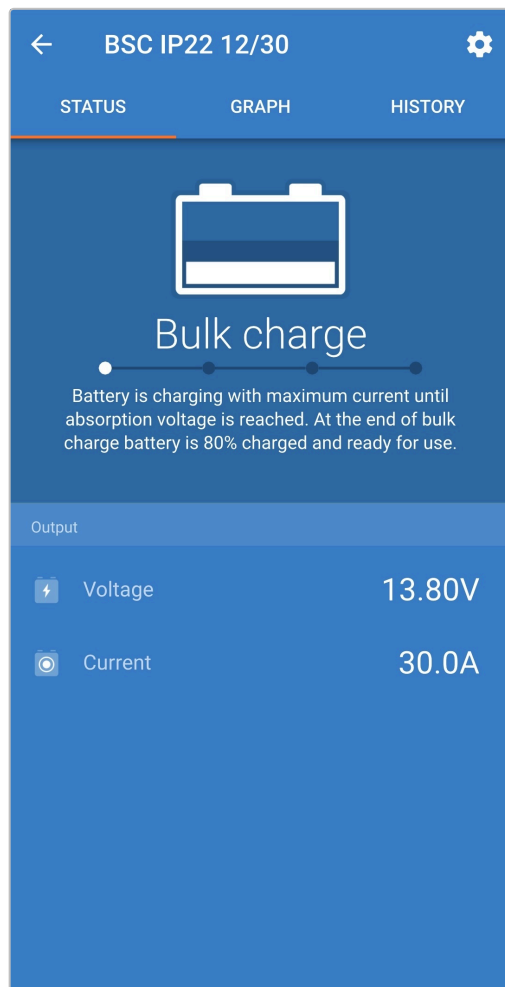

7.2.2. Graph screen

The GRAPH screen provides an easy to understand graphical representation of each charge state with respect to typical battery voltage and charge current.

The active charge stage is also highlighted and stated, along with a brief explanation.

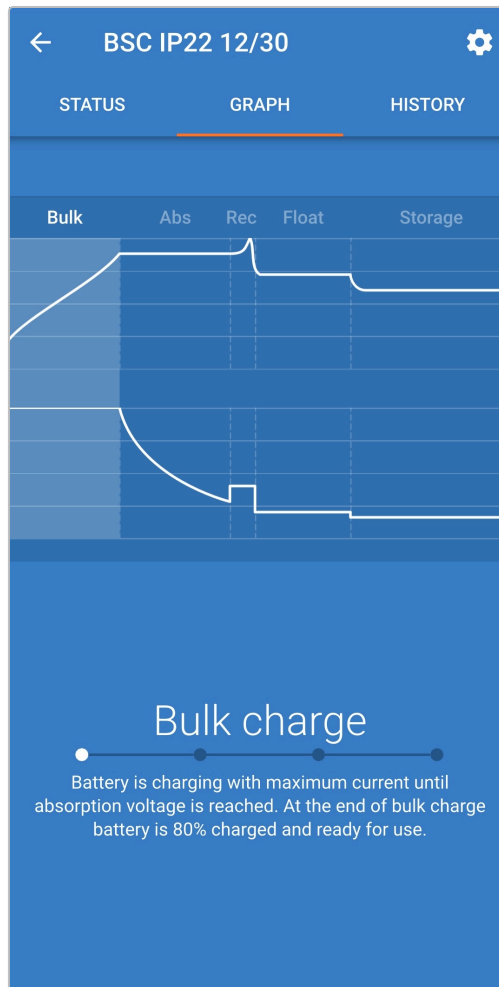

7.2.3. History screen

The HISTORY screen is a very powerful reference as it contains historical usage data over the charger's lifetime and detailed statistics for the last 40 charge cycles (even if the charge cycle is only partially completed).

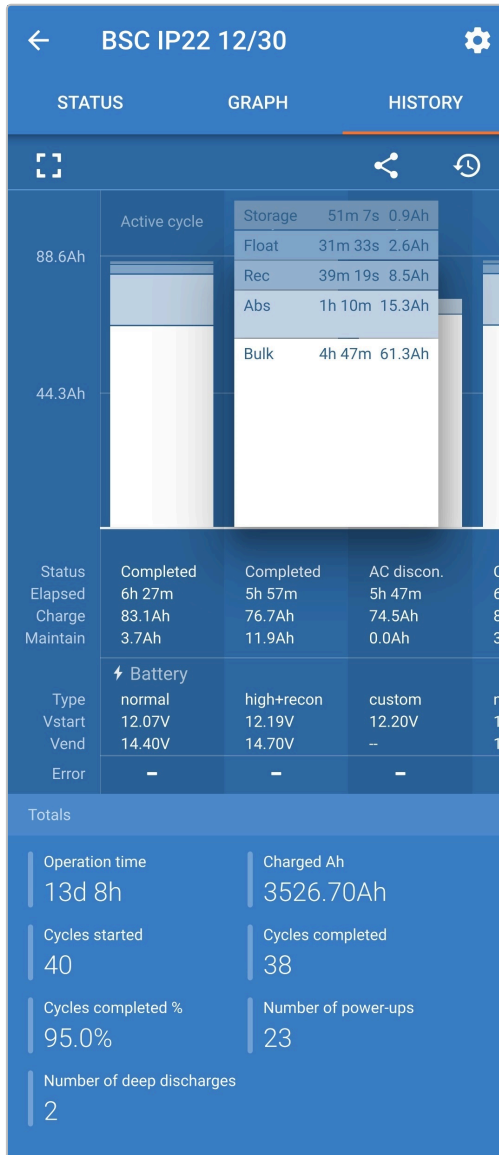

By selecting the full screen view the data is displayed in landscape view with significantly more days visible at the same time.

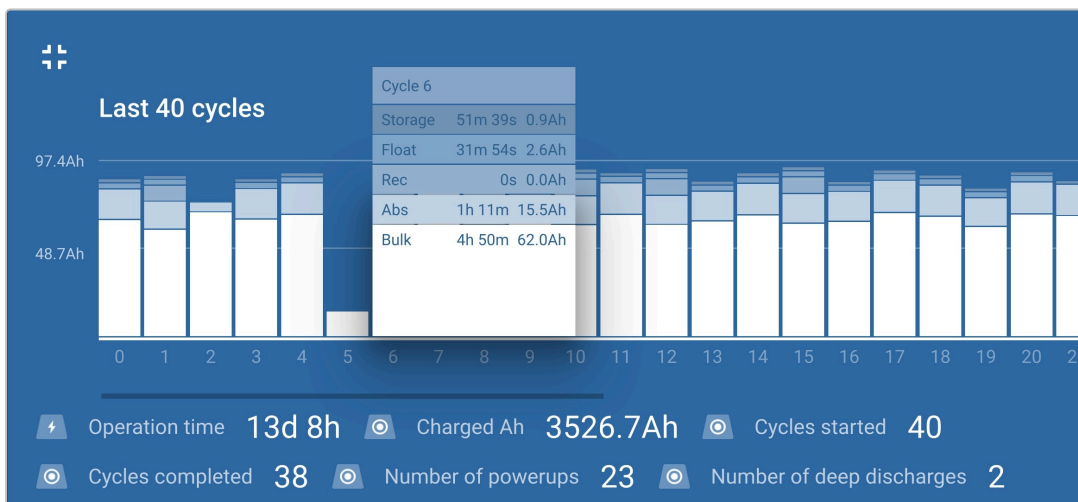

Charge cycle statistics

a. **Cycle overview**

Expandable bar chart showing the time spent in each charge stage and the charge capacity provided (in Ah) during each charge stage

b. **Status**

Confirms if the charge cycle was successfully completed or if it was ended early/interrupted, including the reason/cause

c. **Elapsed**

The elapsed time of the recharge stages (Bulk and Absorption)

d. **Charge**

Total capacity provided during the recharge stages (Bulk and Absorption)

e. **Maintain**

Total capacity provided during the charge maintenance stages (Float, Storage and Recondition)

f. **Type**

The charge cycle mode used; either a 'Built-in preset' mode or a custom 'User defined' configuration

g. **Vstart**

Battery voltage when charging commences

h. **Vend**

Battery voltage when charging is complete (end of absorption stage)

i. **Error**

Displays if any errors occurred during the charge cycle, including the error number and description

Charger lifetime statistics

a. **Operation time**

The total operation time over the lifetime of the charger

b. **Charged Ah**

The total charge capacity (in Ah) provided over the lifetime of the charger

c. **Cycles started**

The total charge cycles started over the lifetime of the charger

d. **Cycles completed**

The total charge cycles completed over the lifetime of the charger

e. **Cycles completed %**

The percentage of charge cycles completed over the lifetime of the charger

f. **Number of power-ups**

The number of times the charger has been powered up over the lifetime of the charger

g. **Number of deep discharges**

The number of times the charger has recharged a deeply discharged battery over the lifetime of the charger

8. Advanced Configuration

8.1. Advanced settings

In specific use cases where the integrated charge modes are not suitable/ideal for the battery type being charged, or the battery manufacturer recommends specific charge parameters and fine tuning is desired, advanced configuration is possible using a Bluetooth enabled device (such as a mobile phone or tablet) with the VictronConnect app.

For most common battery types, advanced configuration is not required or recommended; the integrated charge modes and adaptive charge logic are typically suitable and perform very well.

The advanced settings page enables specific configuration of charge parameters and user defined settings to be saved and easily selected.

Settings	
Battery preset	User defined ▼
Expert mode	<input type="checkbox"/>
Maximum charge current	30.0A
Charge voltage	
Absorption voltage	14.40V
Float voltage	13.80V
Storage voltage	13.20V
Recondition voltage <small>Increases the battery voltage while the current is below 2.4A</small>	Disabled
Voltage compensation	
Temperature compensation	-16.20mV/°C
Battery limits	
Low temperature cut-off	Disabled

To access the advanced settings:

1. Connect the AC power cable to a mains power outlet; after a short delay, the LEDs indicating the current charge mode and charge state will illuminate.
2. Using a Bluetooth enabled device (such as a mobile phone or tablet), open the **VictronConnect** app and locate the **Blue Smart IP22 Charger** in the 'LOCAL' page device list, then connect to the device (default Bluetooth PIN code is 000000).
3. Select the 'Setting' icon (gear in the top right corner) to access the 'Settings' page.



4. Toggle the 'Advanced settings' switch on to enable the 'Advanced settings' page.

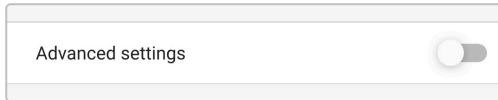

5. Read the warning message and then select 'OK' to accept and progress.

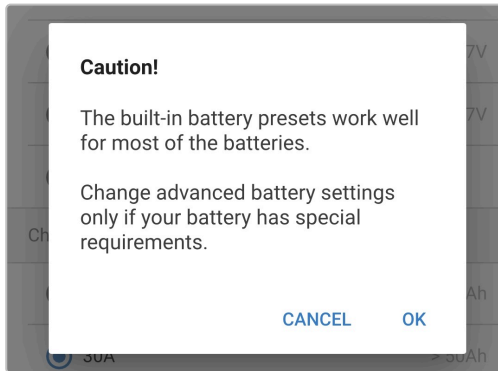

6. Select 'Advanced battery settings' to access the 'Advanced settings' page.

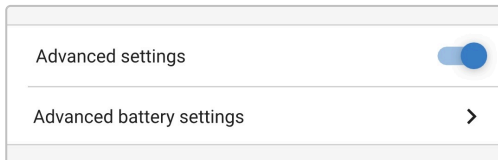

To configure user defined advanced settings:

1. Select the 'Battery preset' dropdown arrow to expand the menu.

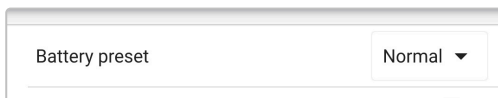

2. Select 'User defined' from the dropdown menu.

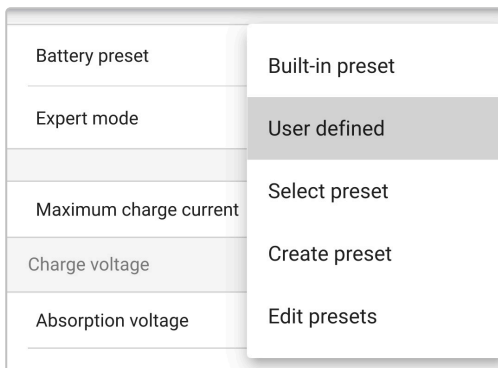

3. 'User defined' configuration will now be enabled.



The image shows a screenshot of a software interface. On the left, there is a text label 'Battery preset'. To its right is a dropdown menu with a downward-pointing arrow. The dropdown menu is open, and the text 'User defined' is visible, indicating it is the selected option.

4. Configure the advanced settings as required per battery manufacturers recommendations.

The advanced settings (with expert mode disabled) include:

a. **Battery preset**

The 'Battery preset' dropdown allows selection from the following options:

i. **Built-in preset**

Selection of a standard integrated pre-set (same as the general settings menu)

ii. **User defined**

Reselection of the last 'user defined' charge settings

iii. **Select preset**

Selection from an extended range of integrated battery charging pre-sets, including new user defined charging pre-sets

iv. **Create preset**

A new charging preset to be created and saved from user defined settings

v. **Edit presets**

An existing preset to be edited and saved

b. **Maximum charge current**

The maximum charge current setting allows selection between the default and a significantly reduced charge current limit preset; Maximum, Low (50% of maximum) or Minimum (25% of maximum) current. Alternatively a user defined maximum charge current (between the minimum and maximum limits) can be configured.

c. **Charge voltage**

The charge voltage settings enable the voltage setpoint for each charge stage to be independently configured and some charge stages (recondition and float) to be disabled or enabled.

The charge voltage setpoint for the following charge stages can be configured:

i. **Absorption**

ii. **Float**

iii. **Storage**

iv. **Recondition**

d. **Voltage compensation**

i. **Temperature Compensation**

The temperature compensation setting enables the charge voltage temperature compensation coefficient to be configured, or temperature compensation to be totally disabled (such as for Li-ion batteries). The temperature compensation coefficient is specified in mV/°C and applies to the entire battery/battery bank (not per battery cell).

8.2. Expert mode settings

Expert mode expands the advanced settings menu even further, to include more specialised expert level configuration settings.

← Settings

Battery preset	User defined ▾
Expert mode	<input checked="" type="checkbox"/>
<hr/>	
Maximum charge current	30.0A
<hr/>	
Charge voltage	
Absorption voltage	14.40V
Float voltage	13.80V
Storage voltage	13.20V
Recondition voltage <small>Increases the battery voltage while the current is below 2.4A</small>	Disabled
BatterySafe <small>Prevent excessive gassing by automatically limiting the rate of voltage increase.</small>	<input checked="" type="checkbox"/>
<hr/>	
Voltage compensation	
Temperature compensation	-16.20mV/°C
<hr/>	
Bulk	
Bulk time limit	1d 0h
Re-bulk method	Constant current
Re-bulk voltage offset	0.10V
Re-bulk current <small>When the charge current exceeds this value while in float/storage, the charge cycle restarts.</small>	Disabled
<hr/>	
Absorption	
Absorption duration	Adaptive
Maximum absorption time	8h 0m
Tail current	Disabled
Repeated absorption	Every 7 days
<hr/>	
Recondition	
Recondition current percentage	8%
Recondition stop mode	Automatic, on voltage ▾
Maximum recondition duration	1h 0m
Manual recondition	START NOW
<hr/>	
Battery limits	
Low temperature cut-off	Disabled

To access the expert mode settings:

1. Open the 'advanced setting' page and enable 'user defined' configuration - see the 'Advanced configuration > Advanced settings' section for instructions.
2. Enable the 'Expert mode' switch, then select 'OK'.
Toggle the 'Expert mode' switch on to enable additional 'Expert mode' settings (extension of the 'advanced settings' menu).



3. Read the warning message and then select 'OK' to accept and progress.

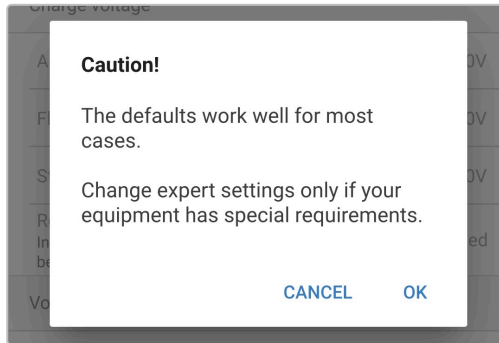

4. The 'Expert mode' settings (extension of the 'advanced settings' menu) will now be enabled.

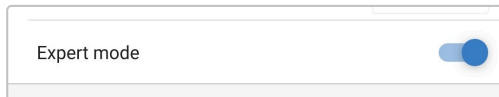

The ADDITIONAL expert mode settings include:

a. **Charge voltage**

i. **BatterySafe**

The BatterySafe setting allows the BatterySafe voltage control to be enabled or disabled. When BatterySafe is enabled, the rate of battery voltage increase during bulk stage is automatically restricted to a safe level. In cases where the battery voltage would otherwise increase at a faster rate, the charge current is reduced to prevent excessive gassing.

b. **Bulk**

i. **Bulk time limit**

The bulk time limit setting restricts the maximum time the charger can spend in bulk stage as a protection measure, since the absorption voltage should have been achieved by this time. If the bulk time limit is satisfied the charger will move directly to float stage.

ii. **Re-bulk method**

The re-bulk method setting allows selection between constant current or battery voltage method to trigger the charger back into bulk charge stage. When the charger is configured in a VE.Smart network with multiple chargers this setting is overridden and battery voltage is used.

iii. **Re-bulk voltage offset**

The re-bulk voltage offset setting is used to determine the re-bulk voltage threshold that will trigger a new charge cycle; the offset is relative to the configured 'Storage voltage' (re-bulk voltage = storage voltage - re-bulk voltage offset). If the battery voltage falls below re-bulk voltage threshold while the charger is in float or storage stage and remains below it for one minute, the charger will move back into bulk charge stage.

iv. **Re-bulk current**

The re-bulk current setting is the charge current limit that will trigger a new charge cycle. If the charge current exceeds the re-bulk current threshold for four seconds while the charger is in float or storage stage, the charger to move back into bulk charge stage.

Note that even when the re-bulk setting is disabled, re-bulk will still occur if the charge current is maintained at the maximum charge current for four seconds while the charger is in float or storage stage.

c. **Absorption**

i. **Absorption duration**

The absorption duration setting allows selection between adaptive absorption time (calculated based on the bulk time / level of discharge) or a fixed absorption time.

ii. **Maximum absorption time / Absorption time**

The maximum absorption time / absorption time setting enables the maximum adaptive absorption time or the fixed absorption time to be configured (depending if adaptive or fixed absorption time is selected). Note that regardless if adaptive or fixed absorption time is selected, the absorption phase can end early based on the tail current setting (if enabled).

iii. **Tail current**

The tail current setting enables the absorption stage to be ended early based on charge current. If the charge current drops below the tail current threshold for one minute, the absorption stage will immediately end and the charger will move to float or storage stage.

iv. **Repeated absorption**

The repeated absorption setting enables the elapsed time between each automatic refresh charge cycle (1h in absorption stage) to be configured. Repeated absorption is enabled by default and can be disabled which results in the battery staying in storage mode indefinitely.

d. **Recondition**

i. **Recondition current percentage**

The recondition current percentage is used to establish the charge current limit while the charger is in recondition stage; the percentage is relative to the configured 'Maximum charge current'. The charger will limit charge current to this lower level while in recondition stage.

ii. **Recondition stop mode**

The recondition stop mode setting allows selection between the recondition stage being ended upon the battery voltage reaching the recondition stage voltage setpoint or a fixed time period.

iii. **Maximum recondition duration**

The recondition time setting enables the maximum recondition time or the fixed recondition time to be configured (depending on the recondition stop mode selected).

iv. **Manual recondition**

Manual recondition can be started by tapping on the START NOW button. The duration of the recondition cycle is limited to a maximum of 1 hour.

8.3. VE.Smart Networking

VE.Smart Networking enables Bluetooth connectivity and communication between multiple Victron products to further enhance the charge cycle; refer to the 'Operation > VE.Smart Networking' section for more information.

After VE.Smart networking compatible hardware is installed, VE.Smart networking needs to be setup/enabled.

8.3.1. Voltage, temperature and current sense

To setup a VE.Smart Network with Volt-Sense / Temp-Sense / Current-Sense:

- Using a Bluetooth enabled device (such as a mobile phone or tablet), open the **VictronConnect** app and locate the battery monitor (BMV, SmartShunt, Smart Battery Sense or VE.Bus Smart Dongle) in the 'LOCAL' page device list, then connect to the device (default Bluetooth PIN code is 000000).

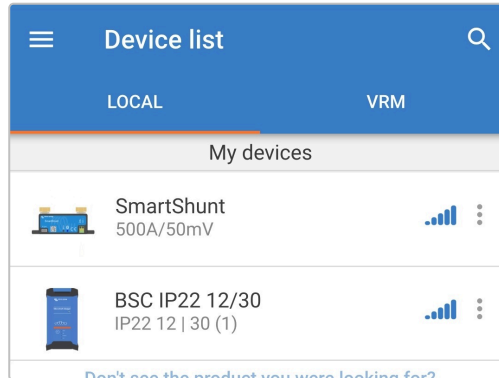

- Select the 'Setting' icon (gear in the top right corner) to access the 'Settings' page.



- Select 'VE.Smart networking' to access the 'VE.Smart networking' page.

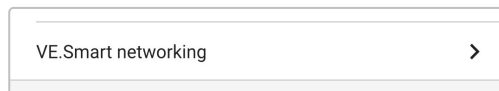

- Select 'CREATE NETWORK' (or 'JOIN NETWORK' if the VE.Smart network has already been created).

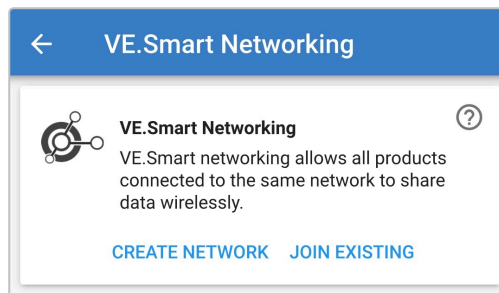

5. Enter a name to identify the VE.Smart network and then select 'OK' to the prompts.

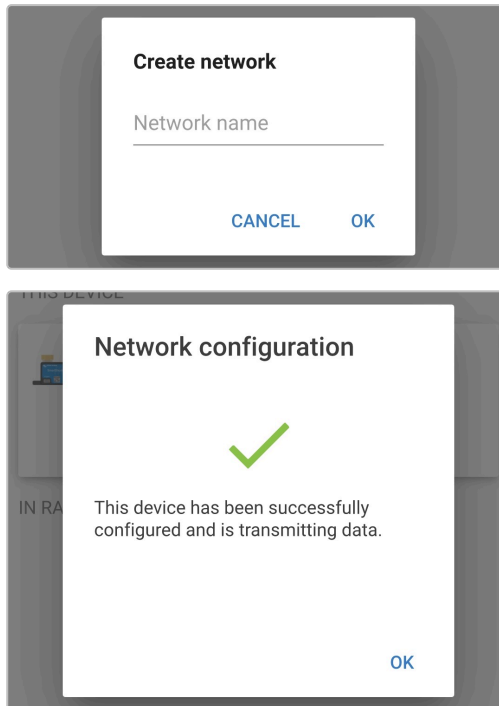

6. Once setup, details of the data being transmitted to the VE.Smart network are shown on the VE.Smart networking page.

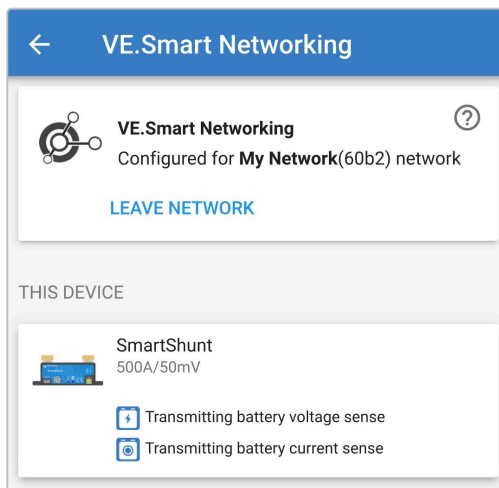

7. Exit the device by selecting the back 'arrow' icon and 'close' icon (cross) in the top left corner.
8. Connect the **Blue Smart IP22 Charger** AC power cable to a mains power outlet; after a short delay, the LEDs indicating the current charge mode and charge state will illuminate.

Blue Smart IP22 Charger

- Using a Bluetooth enabled device (such as a mobile phone or tablet), open the **VictronConnect** app and locate the **Blue Smart IP22 Charger** in the 'LOCAL' page device list, then connect to the device (default Bluetooth PIN code is 000000).

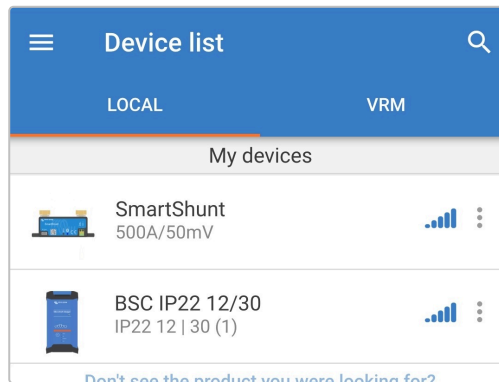

- Select the 'Setting' icon (gear in the top right corner) to access the 'Settings' page.

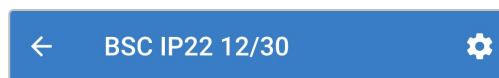

- Select 'VE.Smart networking' to access the 'VE.Smart networking' page.

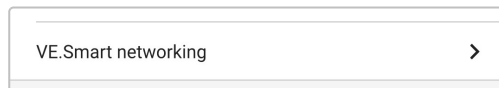

- Select 'JOIN EXISTING'.

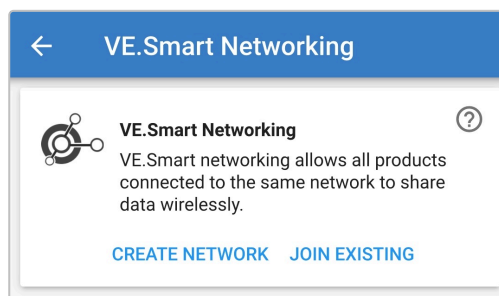

13. Select the VE.Smart network previously setup (or the network you want to join if there are multiple), then select 'OK' to the prompts.

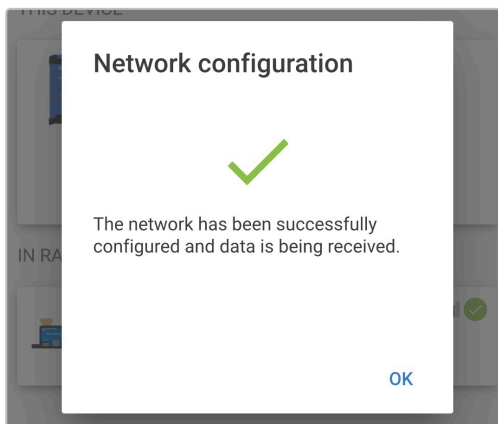
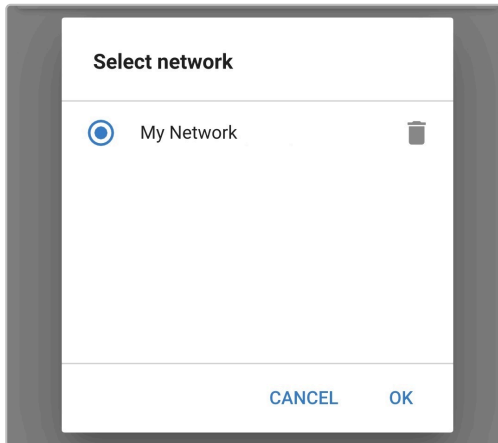

14. The VE.Smart network is now configured, details of the data being received from the VE.Smart network are shown on the VE.Smart network page.

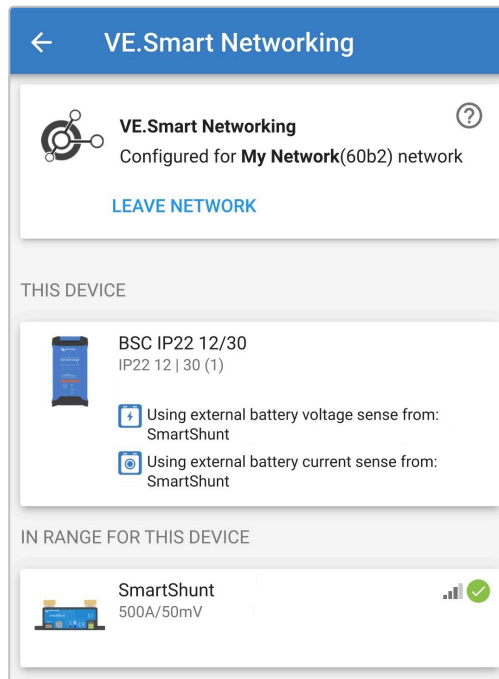

Once successfully configured:

- a. The VE.Smart network symbol will appear in the top right corner of the STATUS screen (both the battery monitor and the charger).

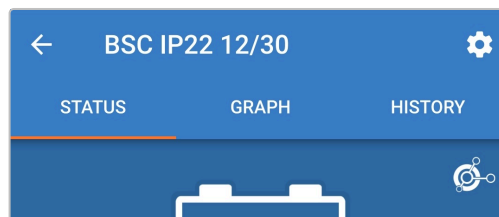

- b. The active charge state LED on the charger (BULK, ABS, FLOAT and STORAGE) will blink (turn off) momentarily every 4 seconds.



15. For systems with multiple compatible chargers, repeat the relevant steps above for each additional charger.

 Multiple chargers in a common VE.Smart network must have the same charge settings, since the 'master' can change dynamically any charger could become the 'master'.

8.3.2. Synchronised charging

To setup a VE.Smart Network with Synchronised charging:

1. Connect the AC power cable for all compatible chargers to a mains power outlet; after a short delay, the LEDs indicating the current charge mode and charge state will illuminate.
2. Using a Bluetooth enabled device (such as a mobile phone or tablet), open the **VictronConnect** app and locate the first **Blue Smart IP22 Charger** in the 'LOCAL' page device list, then connect to the device (default Bluetooth PIN code is 000000).

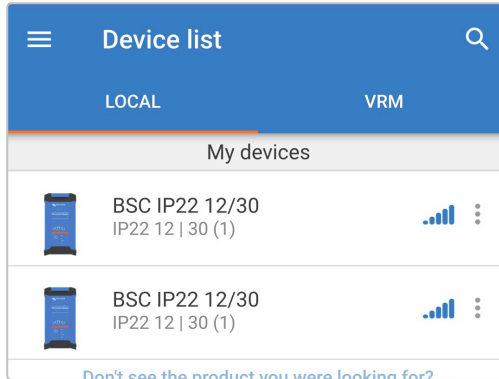

3. Select the 'Setting' icon (gear in the top right corner) to access the 'Settings' page.



4. Select 'VE.Smart networking' to access the 'VE.Smart networking' page.

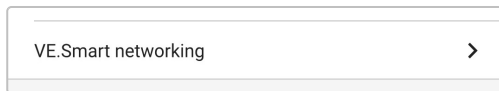

5. Select 'CREATE NETWORK' (or 'JOIN NETWORK' if the VE.Smart network has already been created).

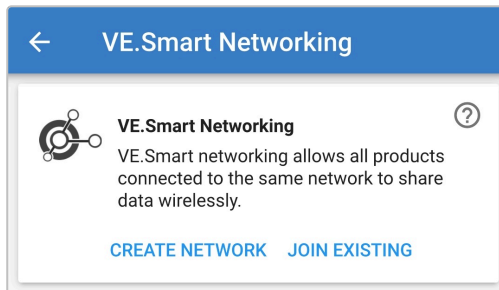

6. Enter a name to identify the VE.Smart network and select 'OK' to the prompts.

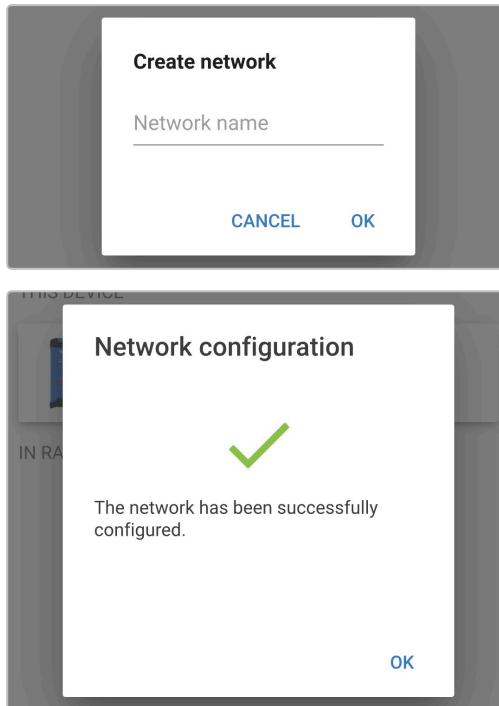

7. Once setup, details of the data being transmitted to the VE.Smart network are shown on the VE.Smart networking page.

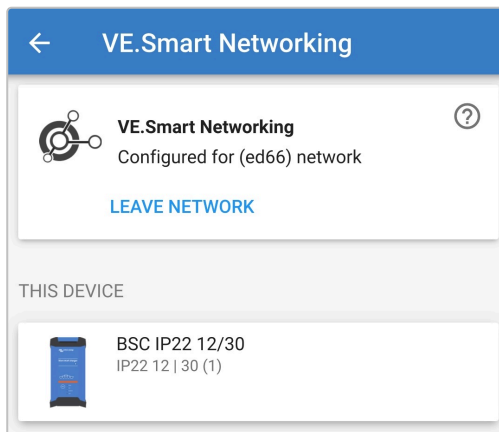

8. Exit the device by selecting the back 'arrow' icon and 'close' icon (cross) in the top left corner.
9. Using a Bluetooth enabled device (such as a mobile phone or tablet), open the **VictronConnect** app and locate another compatible charger in the 'LOCAL' page device list, then connect to the device (default Bluetooth PIN code is 000000).

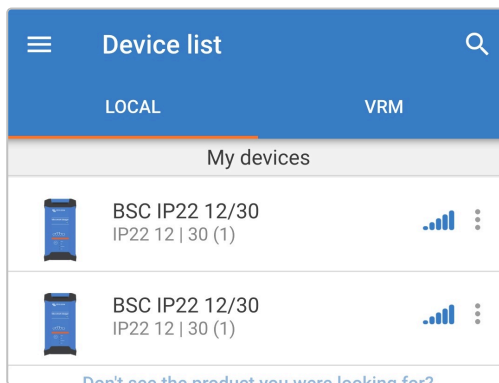

10. Select the 'Setting' icon (gear in the top right corner) to access the 'Settings' page.



11. Select 'VE.Smart networking' to access the 'VE.Smart networking' page.

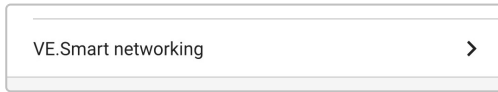

12. Select 'JOIN EXISTING'.

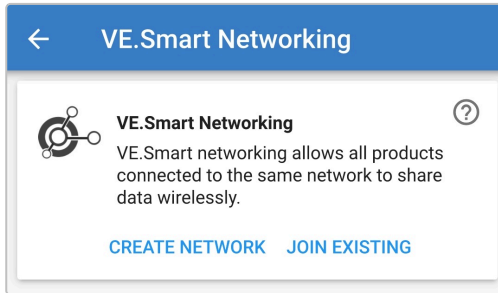

13. Select the VE.Smart network previously setup (or the network you want to join if there are multiple), then select 'OK' to the prompts.

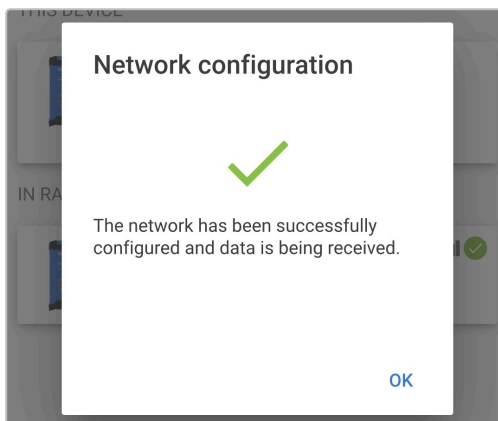
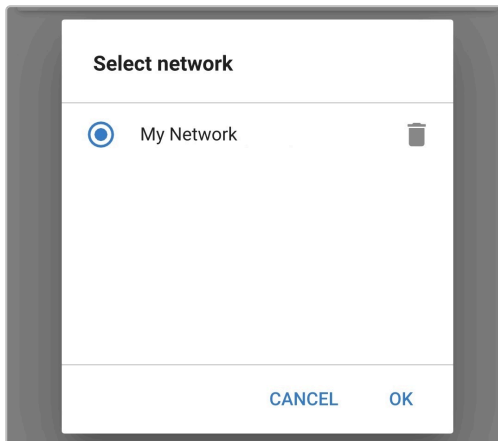

14. The VE.Smart network is now configured, details of the synchronised chargers in the VE.Smart network are shown on the VE.Smart network page.

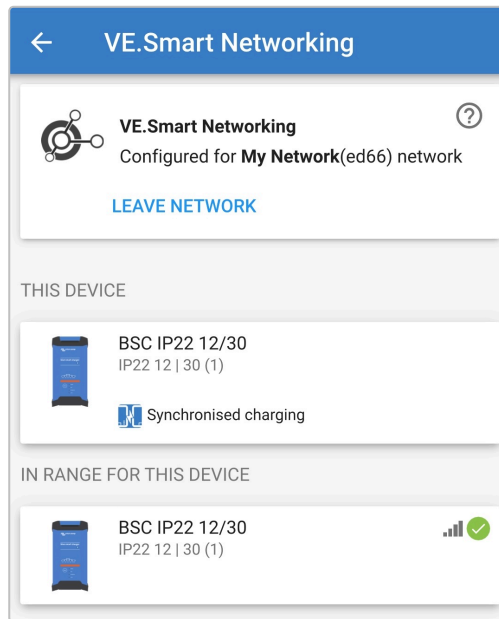

Once successfully configured:

- a. The VE.Smart network symbol will appear in the top right corner of the STATUS screen (of each charger in the network).

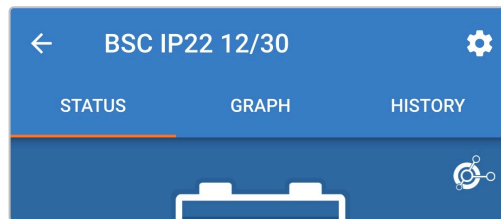

- b. The active charge state LED on the charger (BULK, ABS, FLOAT and STORAGE) will blink (turn off) momentarily every 4 seconds.



15. For systems with multiple compatible chargers, repeat the relevant steps above for each additional charger.

 Multiple chargers in a common VE.Smart network must have the same charge settings, since the 'master' can change dynamically any charger could become the 'master'.

8.4. Power supply mode

The **Blue Smart IP22 Charger** range are also suitable for use as a DC power supply, to power equipment without a battery connected (or while also connected to a battery).

While it's still possible to use the charger as a power supply without changing any settings, a dedicated 'Power supply' mode exists for this purpose/usage and is recommended.

If the charger will be used as a power supply, it is recommended to activate 'Power supply' mode, as it will disable the internal charge logic and provide a constant DC supply voltage.

To enable power supply mode:

1. Connect the AC power cable to a mains power outlet; after a short delay, the LEDs indicating the current charge mode and charge state will illuminate.
2. Using a Bluetooth enabled device (such as a mobile phone or tablet), open the **VictronConnect** app and locate the **Blue Smart IP22 Charger** in the 'LOCAL' page device list, then connect to the device (default Bluetooth PIN code is 000000).
3. Select the 'Setting' icon (gear in the top right corner) to access the 'Settings' page.



4. Select the 'Function' mode (Charger) to expand the dropdown menu.



5. Select 'Power supply' mode from the dropdown menu.

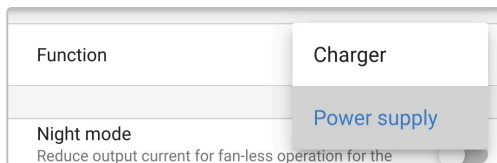

6. 'Power supply' mode will now be enabled; when enabled the BULK, ABS, FLOAT and STORAGE LEDs will be illuminated.

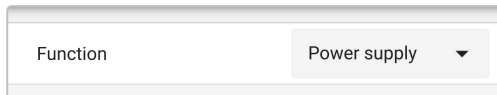

7. If required, adjust the desired output voltage and/or the 'Maximum current' limit.

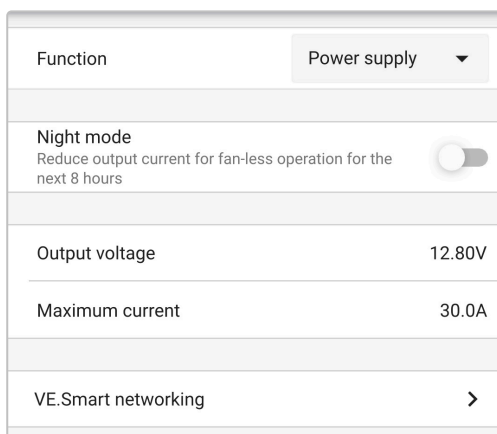

To revert the charger function back to use as a normal battery charger, follow steps 1 to 3 above and then select 'Charger' mode from the 'Function' drop down menu.

9. Technical specifications

Specification		12/15	12/20	12/30	24/8	24/12	24/16
Input voltage (Nominal Min/Max)		220 - 240VAC 180 - 265VAC					
Input frequency (Nominal Min/Max)		50 - 60Hz 45 - 65Hz					
Power factor		>0.6					
Standby power		0.5W					
Max efficiency		93%			94%		
Charge voltage (Absorption Float Storage)	Normal	14.4V 13.8V 13.2V			28.8V 27.6V 26.4V		
	High	14.7V 13.8V 13.2V			29.4V 27.6V 26.4V		
	Li-ion	14.2V N/A 13.5V			28.4V N/A 27.0V		
Temperature compensation (N/A for Li-ion)		-16mV/°C (-9mV/°F)			-32mV/°C (-18mV/°F)		
Charge algorithm		6-stage adaptive (3 stage for Li-ion)					
Charge current limit (in selected mode)	Max	15A	20A	30A	8A	12A	16A
	Low	7.5A	10A	15A	4A	6A	8A
	Min	3.7A	5A	7.5A	2A	3A	4A
Max battery capacity (≥0.1C in max mode)		150Ah	200Ah	300Ah	80Ah	120Ah	160Ah
Min battery capacity - Lead-acid (≤0.3C in selected mode)	Max	50Ah	67Ah	100Ah	27Ah	40Ah	53Ah
	Low	25Ah	33Ah	50Ah	13Ah	20Ah	27Ah
	Min	12Ah	17Ah	25Ah	7Ah	10Ah	13Ah
Min battery capacity - Li-ion (≤0.5C in selected mode)	Max	30Ah	40Ah	60Ah	16Ah	24Ah	32Ah
	Low	15Ah	20Ah	30Ah	8Ah	12Ah	16Ah
	Min	7Ah	10Ah	15Ah	4Ah	6Ah	8Ah
Fault protection		Reverse polarity (fuse), output short circuit and over temperature					
Remote on/off		No					
Communication		Bluetooth (via VictronConnect app)					
Bluetooth power and frequency		+4dBm 2402 - 2480MHz					
Cooling		Fan assisted (except 12/15 and 24/08)					
Operating temperature range		-20 to +50°C (0 to 120°F) Full rated output up to 40°C (100°F)					
Max humidity		95%					
Enclosure							
Material and colour		Aluminium Blue RAL 5012					
AC connection		1.5m (5ft) cable with CEE 7/7, BS 1363 or AS/NZS 3112 plug					
Battery connection		Screw terminals 16 mm ² (AWG6)					
Number of battery connections		1 and 3 output models available (except 24/8 and 24/12)					
Protection category		IP22					
Weight		1.3 kg (2.9 lbs)					
Dimensions (h x w x d)		235 x 108 x 65 mm (9.3 x 4.3 x 2.6 inch)					
Compliance standards							
Safety		EN 60335-1, EN 60335-2-29					
Emission		EN 55014-1, EN 61000-6-3, EN 61000-3-2					
Immunity		EN 55014-2, EN 61000-6-1, EN 61000-6-2, EN 61000-3-3					
Automotive		E4-10R					

10. Warranty

This limited warranty covers defects in materials and workmanship in this product, and lasts for five years from the date of original purchase of this product.

The customer must return the product together with the receipt of purchase to the point of purchase.

This limited warranty does not cover damage, deterioration or malfunction resulting from alteration, modification, improper or unreasonable use or misuse, neglect, exposure to excess moisture, fire, improper packing, lightning, power surges, or other acts of nature.

This limited warranty does not cover damage, deterioration or malfunction resulting from repairs attempted by anyone unauthorized by Victron Energy to make such repairs.

Victron Energy is not liable for any consequential damages arising from the use of this product.

The maximum liability of Victron Energy under this limited warranty shall not exceed the actual purchase price of the product.